

EXPLORER® 500

USER MANUAL

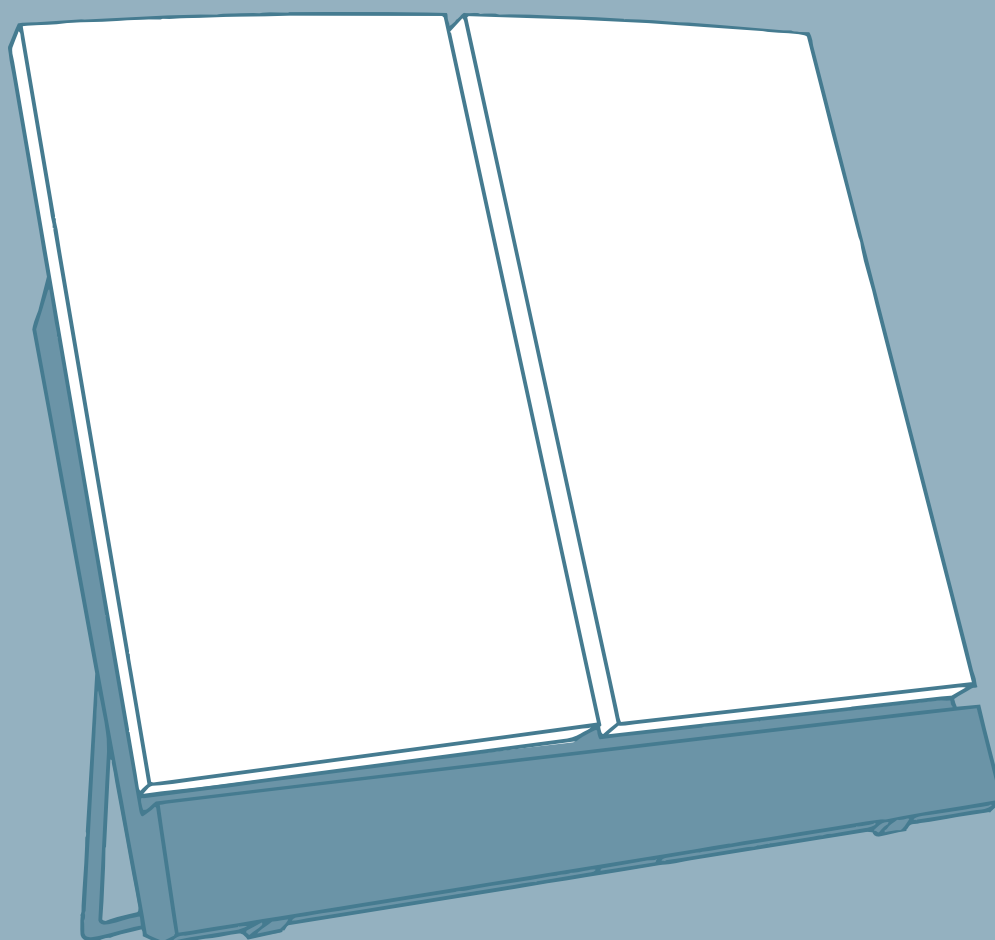

TT-3710A EXPLORER[®] 500

Document number: TT 98-122274-Q

Release date: 21 January 2008

Information in this document is subject to change without notice and does not represent a commitment on the part of Thrane & Thrane A/S.

Copyright © 2008 Thrane & Thrane A/S. All rights reserved.

Trademark acknowledgements

- **Thrane & Thrane** is a registered trademark of Thrane & Thrane A/S in the European Union and the United States.
- **EXPLORER** is a registered trademark of Thrane & Thrane A/S in the European Union and the United States.
- **Bluetooth** is a registered trademark of Bluetooth SIG.
- **Windows** and **Outlook** are registered trademarks of Microsoft Corporation in the United States and other countries.
- **Inmarsat** is a registered trademark of the International Maritime Satellite Organisation (IMSO) and is licensed by IMSO to Inmarsat Limited and Inmarsat Ventures plc.
- Inmarsat's product names are either trademarks or registered trademarks of Inmarsat.
- Other product and company names mentioned in this manual may be trademarks or trade names of their respective owners.

Company Addresses

www.thrane.com

Denmark	Denmark Company headquarters	Norway
Thrane & Thrane Aalborg A/S Porsvej 2 DK-9200 Aalborg SV Denmark	Thrane & Thrane A/S Lundtoftegårdsvej 93 D DK-2800 Kgs. Lyngby Denmark	Thrane & Thrane Norway Bergerveien 12 PO Box 91 1375 Billingstad, Norway
USA	China	
Thrane & Thrane, Inc. 509 Viking Drive, Suites K, L and M Virginia Beach, VA 23452 USA	Thrane & Thrane Shanghai Unit 602 - Building 4, 289 Bisheng Rd. Zhangjiang High-tech Park, Pudong, 201204 Shanghai P. R. China	

Safety summary

The following general safety precautions must be observed during all phases of operation, service and repair of this equipment.

Failure to comply with these precautions or with specific warnings elsewhere in this manual violates safety standards of design, manufacture and intended use of the equipment. Thrane & Thrane A/S assume no liability for the customer's failure to comply with these requirements.

Do not operate in an explosive atmosphere

Do not operate the equipment in the presence of flammable gases or fumes. Operation of any electrical equipment in such an environment constitutes a definite safety hazard.

Keep away from live circuits

Operating personnel must not remove equipment covers. Component replacement and internal adjustment must be made by qualified maintenance personnel. Do not replace components with the power cable connected. Under certain conditions, dangerous voltages may exist even with the power cable removed. To avoid injuries, always disconnect power and discharge circuits before touching them.

Do not service alone

Do not attempt internal service or adjustments unless another person, capable of rendering first aid resuscitation, is present.

Do not substitute parts or modify equipment

Because of the danger of introducing additional hazards, do not substitute parts or perform any unauthorized modification to the equipment.

Keep away from active antenna front

This device emits radio frequency energy when antenna pointing is completed. To avoid injury, keep a minimum safety distance of 0.6 m from the antenna front when the EXPLORER 500 is pointed. See also the below section *Antenna safety instructions*.



Only use approved batteries from Thrane & Thrane

Use of non approved batteries may result in explosion, fire, electrical shock or injury.

Observe marked areas

Under extreme heat conditions do not touch areas of the EXPLORER 500 that are marked with this symbol, as it may result in injury.



Antenna safety instructions

Use only manufacturer supplied antennas

Antenna minimum safe distance: 60 cm

Antenna gain

Directional, with maximum gain of 11.1 dB reference to isotropic.

The Federal Communications Commission has adopted a safety standard for human exposure to RF (Radio Frequency) energy which is below the OSHA (Occupational Safety and Health Act) limits.

Antenna mounting

The antenna supplied by the manufacturer must be located such that during radio transmission, no person or persons can come closer than the above indicated minimum safe distance to the antenna, i.e. 60 cm.

To comply with current FCC RF Exposure limits, the antenna must be installed at or exceeding the minimum safe distance shown above, and in accordance with the requirements of the antenna manufacturer or supplier.

Antenna substitution

Do not substitute any antenna for the models supplied or recommended by the manufacturer. You may be exposing people to excess radio frequency radiation. You may contact the manufacturer for further instructions.

Radiation warning



WARNING! Maintain a separation distance of at least 60 cm from the front face of the antenna to a person.

You, as the qualified end user of this radio device, must control the exposure conditions of bystanders to ensure the minimum separation distance (above) is maintained between the antenna and nearby persons, for satisfying RF Exposure compliance. The operation of this transmitter must satisfy the requirements of Occupational/Controlled Exposure Environment, for work-related use. Only use the terminal when persons are at least the minimum distance from the front face of the antenna.

About this manual

Intended readers

This manual is a user manual for the EXPLORER 500. The readers of the manual include anyone who is using or intends to use the EXPLORER 500. No specific skills are required to operate the EXPLORER 500. However, it is important that you observe all safety requirements listed in the *Safety summary* and in the *Antenna safety instructions* in the beginning of this manual, and operate the EXPLORER 500 according to the guidelines in this manual.

Manual overview

This manual may not always reflect the latest software functionality of your EXPLORER 500. To obtain the latest version of the manual, please enter the Thrane & Thrane Extranet and download the latest version, or acquire it from your distributor.

The manual has the following chapters:

- **Introduction** contains an overview of the BGAN services and a brief description of the system.
- **Getting started** explains how to insert SIM card and battery, start up the unit, and navigate the display menus. It also contains a short guide to making the first call.
- **Using the display and keypad** contains an overview of the display menu system and explains how to use the menus.
- **Using the interfaces** explains how to set up and use each interface.
- **Using the web interface** explains how to use the built-in web interface of the EXPLORER 500, and describes available menus and settings. It also explains setup of interfaces with the web interface.
- **Maintenance and troubleshooting** contains a short troubleshooting guide and explains how to update software. It also describes and lists the alarm messages that may appear in the handset, and gives information on where to get further help if necessary.

Typography

In this manual, typography is used as indicated below:

Bold is used for the following purposes:

- To emphasize words.
Example: “Do **not** touch the antenna front during transmission”.
- To indicate what the user should select in the user interface.
Example: “Select **Settings** > **Bluetooth** and click **Enabled**”.

Italic is used to emphasize the paragraph title in cross-references.

Example: “For further information, see *Connecting Cables* on page...”.

COURIER is used for the following purposes:

- To indicate text appearing in the display.
Example: “the Main screen shows **READY**”.
- To indicate low level commands such as AT commands.
Example: “In your terminal program, type **ATD**”.

Table of Contents

	Safety summary	iii
	Antenna safety instructions	iv
	About this manual	v
Chapter 1	Introduction	
	Welcome	1
	In this chapter	1
	The BGAN system	2
	The BGAN services	4
	Features and interfaces of the EXPLORER® 500	5
	Your EXPLORER® 500 terminal	7
	Matrix of services and communication interfaces	10
	What's next?	10
Chapter 2	Getting started	
	In this chapter	11
	Unpacking and assembling	11
	Placing the EXPLORER® 500	15
	Connecting cables	15
	Powering the EXPLORER® 500	17
	Options for the start-up procedure	18
	Entering the SIM PIN	20
	Pointing the antenna	21
	Using a fixed EXPLORER® 500 (semi-fixed installation)	26
	Making the first call	27
	Making the first data connection (LAN)	29
	What's next?	30
Chapter 3	Using the display and keypad	
	In this chapter	31
	Menu overview	31
	Display during start-up	33
	Display symbols	34
	Navigating the display and keypad	35

The menus	36
Messages menu	37
Connect menu	38
Calls menu	39
Settings menu	40
Properties menu	43
Help desk	45
Dynamic information in the display	46
What's next?	47
Chapter 4 Using the interfaces	
In this chapter	48
General	48
Tools for setup and use	48
Services and interfaces	49
Enabling or disabling an interface	50
Bluetooth pairing	51
What is pairing?	51
Pairing devices in which you can enter a passkey	51
Using a phone or fax machine	52
Selecting the call type	52
Connecting an analog phone or a fax machine	54
Connecting a Bluetooth handset	55
Entering the SIM PIN using a phone	56
Making or receiving a phone call with the EXPLORER® 500	57
Making a call to the EXPLORER® 500	58
Dialing functions	59
Sending or receiving a fax message	62
Using a computer	63
Choosing an interface for data connection	63
Standard or Streaming data	64
Using the LAN interface	65
Using the USB interface	67
Using a computer with Bluetooth	70
Creating a dial-up connection	71
Additional interfaces	73

Using the EXPLORER® Bluetooth Handset charger	73
What's next?	73
Chapter 5 Using the web interface	
In this chapter	74
Introduction	74
The web interface	74
Accessing and navigating the web interface	76
Entering the SIM PIN in the web interface	78
The Dashboard	79
Overview	79
Terminal properties	79
Managing calls and data sessions	80
Pointing using web interface	81
Using the phone book	82
General usage	82
Editing phone book entries	83
Call log	84
Information on total usage	84
Exporting the call log	84
Viewing the lists of calls	85
Handling messages	86
Sending an SMS message from the EXPLORER® 500	86
Options for messages in the Outbox	87
Options for messages in the Sent folder	87
Sending an SMS message to the EXPLORER® 500	88
Receiving a message	88
Options for new SMS messages	89
Options for SMS messages in the Inbox	89
Configuring message settings	90
EXPLORER® 500 settings	92
Accessing the EXPLORER® 500 settings	92
Power up behavior	92
Setting the display backlight and contrast	93
Turning audio indicators on or off	94
Enabling activation of stealth mode	94

Setting up the interfaces	95
Enabling/disabling interfaces	95
Description of data settings	95
Configuring the USB interface	97
Configuring the LAN interface	99
Configuring the Bluetooth interface	104
Pairing Bluetooth devices from the web interface	107
Configuring the Phone/Fax settings	110
Setting up call services	111
Setting a common APN	117
Selecting the GPS antenna	118
Setting the language	119
Properties, software upload and alarm list	120
Viewing the properties of the EXPLORER [®] 500	120
Uploading software	121
Viewing the Alarm List	124
Administration	125
Accessing the administration settings	125
Using Profiles	130
Using a Traffic Flow Template	133
Setting up user permissions	135
Help desk and diagnostic report	136
Accessing the Help desk	136
Generating a diagnostic report	136
What's next?	137
Chapter 6 Maintenance and troubleshooting	
In this chapter	138
Getting support	138
Uploading software	139
Maintenance	139
Options and accessories	141
Troubleshooting guide	142
Status signaling	149
Alarm messages	149
Log files	154

Appendix A Technical specifications

In this appendix	155
General specifications	155
Battery	156
Power input	157
SIM interface	157
Phone/Fax interface	158
LAN interface	159
USB interface	160
Bluetooth interface	161
Built-in antenna	162
EXPLORER® Bluetooth Handset charger interface	163
Serial number label	164
Conformity	165

Appendix B AT commands

In this appendix	167
Starting up an AT command session	167
List of supported AT commands	168

Glossary	174
-----------------------	-----

Index	178
--------------------	-----

Introduction

Welcome

Congratulations on the purchase of your EXPLORER 500!

The EXPLORER 500 is a broadband mobile terminal with integrated antenna, providing high-speed data and voice communication via satellite through the Broadband Global Area Network (BGAN).

Just plug in a phone, fax, laptop or PDA, or use the Bluetooth® interface, point the antenna towards the BGAN satellite - and you are online.

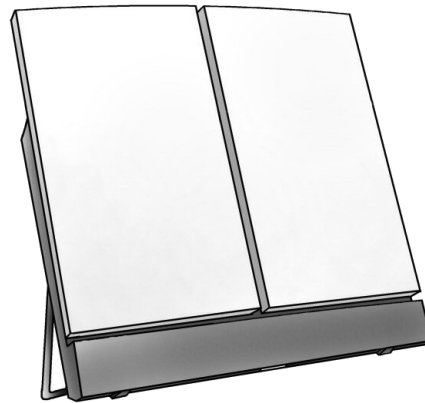

The flat, light-weight design of the EXPLORER 500 makes it easy to carry e.g. in the front pocket of a laptop bag.

Applications include:

- Internet browsing
- E-mail
- Phone and fax services
- Large file transfers
- Video conferencing and Streaming
- VPN (Virtual Private Network) access to corporate servers

In this chapter

This chapter gives an overview of the BGAN system and services, and introduces the EXPLORER 500.

It also gives an overview of the physical unit and its features and functions.

The BGAN system

What is BGAN?

The Broadband Global Area Network (BGAN) is a mobile satellite service that offers high-speed data up to 492 kbps and voice telephony. BGAN enables users to access e-mail, corporate networks and the Internet, transfer files and make telephone calls.

Coverage

The Inmarsat® BGAN services are based on geostationary satellites situated above the equator. Each satellite covers a certain area (footprint). The coverage map below shows the footprints of the BGAN system.

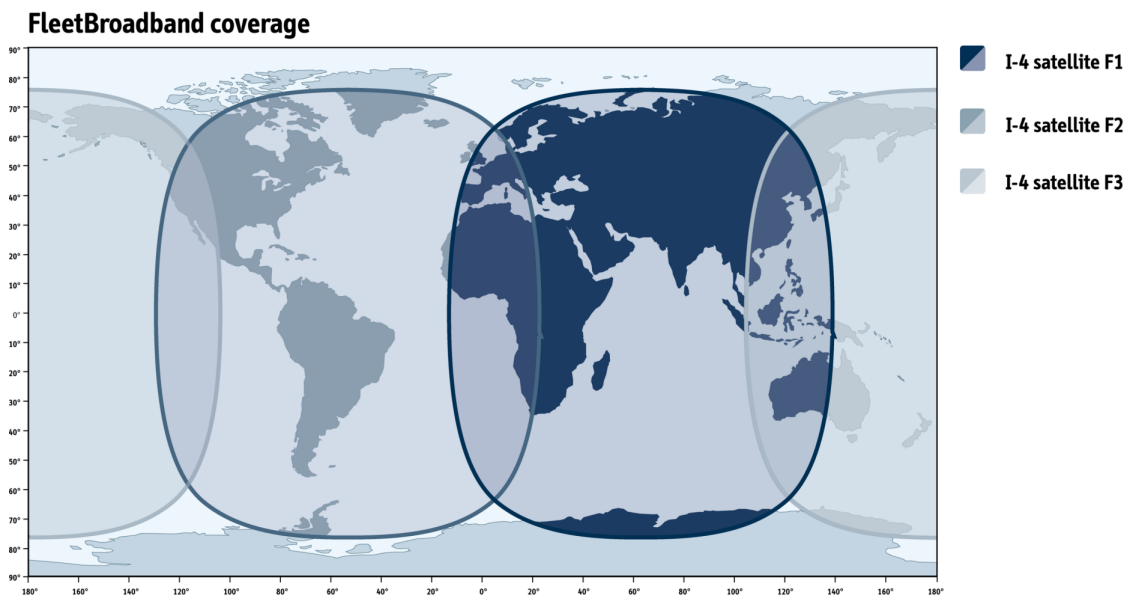

Note

The map depicts Inmarsat's expectations of coverage, but does not represent a guarantee of service. The availability of service at the edge of coverage areas fluctuates depending on various conditions.

The launch of the F3 satellite (POR) will be determined in due course.

Overview of the BGAN system

A complete BGAN system may include the EXPLORER 500 with connected peripherals, the BGAN satellite, and the Satellite Access Station (SAS). The satellites are the connection between your EXPLORER 500 and the SAS, which is the gateway to the worldwide networks (Internet, telephone network, cellular network, etc.).

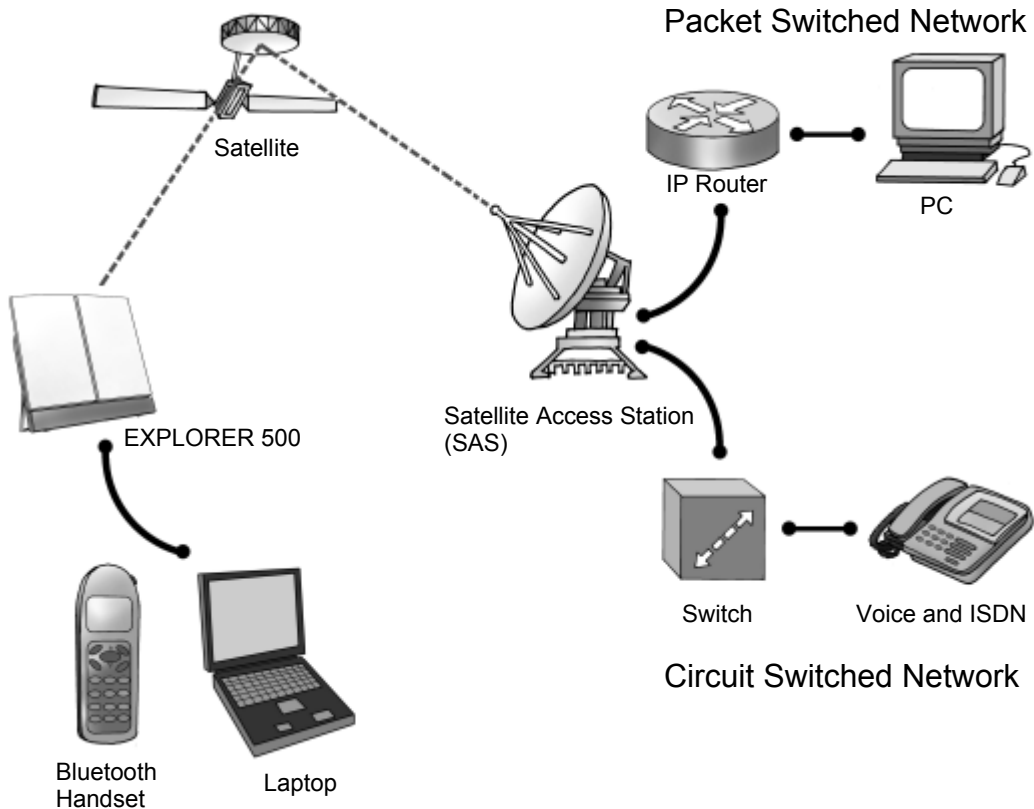

The BGAN services

Supported services

The services currently supported by BGAN comprise:

- A Packet Switched connection to the Internet
- A Circuit Switched (Dialed) connection for voice, fax or data
- Short Messaging Service (SMS)

Packet data service

The BGAN network supports different classes of data connection to the Internet.

- Using a **Standard data** connection, several users can share the data connection simultaneously. This type of connection is ideal for e-mail, file transfer, and Internet and intranet access. The user pays for the amount of data sent and received.
- Using a **Streaming data** connection, you get an exclusive, high-priority connection, ensuring seamless transfer of data. This type of connection is ideal for time critical applications like live video over IP. The user pays for the duration of the connection (per minute charge).

Circuit switched (dialed) service

Two types of circuit switched connection are available:

- **Standard Voice.** A low-tariff connection for voice only. The voice signal is compressed to 4.0 kbps, which reduces the bandwidth use and consequently the tariff.
- **3.1 kHz Audio.** A high quality connection which can be used for Premium Voice, G3 fax or analog modems.
The signal is uncompressed 3.1 kHz audio, which allows for optimum voice quality.
- **ISDN.** A high quality connection which can be used for voice (3.1 kHz Audio), G4 fax or 64 kbps UDI/RDI data. (not supported by the EXPLORER 500)

SMS service

The BGAN system provides a Short Messaging Service (SMS) for sending and receiving messages.

Supplementary services

The BGAN system also provides the following supplementary services:

- Call hold
- Call waiting
- Call forwarding
- Voice mail
- Call barring

- Calling line identification
- Closed user group

Features and interfaces of the EXPLORER® 500

Features

The EXPLORER 500 provides the following features:

- High speed data up to 464 kbps - shared bandwidth
- Support for Streaming classes 32, 64 and 128 kbps
- Simultaneous voice and data
- Standard LAN, USB, Bluetooth and phone/fax ports
- Built-in web interface allowing you to manage your phone book, messages and calls, and customize the terminal to your specific needs
- 100-240 V AC power adapter
- Lightweight and portable design
- Easy setup and use
- Robust and durable design
- CE, FCC and GMPCS certified

Overview of interfaces

The EXPLORER 500 provides a number of interfaces for connection of various types of computers, fax devices and phones.

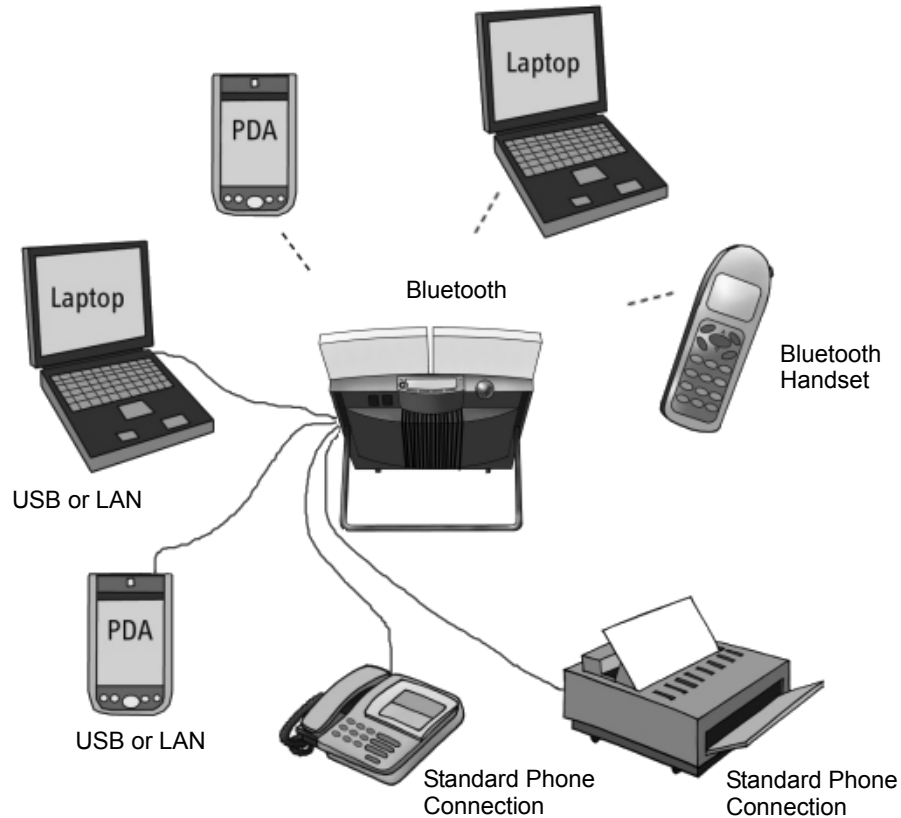

Using the interfaces on page 48 describes how to use each of the available interfaces.

Minimizing power consumption

The EXPLORER 500 is designed for minimum power consumption. This means that functions that are not currently used will automatically go into a “sleep mode” to minimize the power consumption.

In addition to this automatic sleep mode function, you can disable each of the interfaces if they are not currently used. Note, however, that you will not be able to use these interfaces until you enable them again. For information on how to enable/disable interfaces, see *Enabling or disabling an interface* on page 50.

Your EXPLORER[®] 500 terminal

Overview

The EXPLORER 500 is a compact unit comprising antenna, compass, display and keypad, all in one unit.

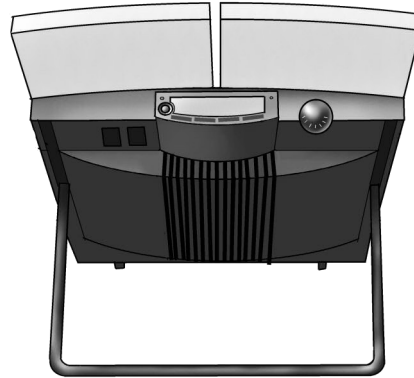

Display and keypad

The EXPLORER 500 has a display and a keypad for displaying status and for setting up the EXPLORER 500.



For information on how to use the keypad and display, and for an overview of the display menu system, see *Using the display and keypad* on page 31.

Light indicators

The EXPLORER 500 has two light indicators next to the display: a green power indicator and a red message indicator.

Green Power indicator

The function of the green Power indicator to the left of the display is as follows:

Behavior of green indicator	Meaning
Short flash every 2 seconds	The EXPLORER 500 is on.
Steady light	The battery is charging.
Flashing rapidly	A charging error has occurred. For further information, refer to the <i>Troubleshooting Guide</i> on page 142.
Off	No power or Stealth mode.

Red Message indicator

The function of the red Message indicator is as follows:

Behavior of red indicator	Meaning
Flashing	An alarm is active or An SMS message has arrived. Press OK on the keypad to view the alarm(s) or SMS message(s). ^a The red light will keep flashing after OK is pressed if <ul style="list-style-type: none"> • there are more SMS messages, or • an alarm is still active. For information on alarm messages, see <i>Alarm messages</i> on page 149.
Off	No messages are present, or the EXPLORER 500 is in Stealth mode.

a. If a computer is connected, you can also view alarms and SMS messages in the built-in web interface in the EXPLORER 500. For further information, see *Icons in the icon bar* on page 77.

User interfaces

The **keypad and display** are used for pointing the antenna, for displaying status and for changing simple parameters.

To obtain full access to all features and for ease-of-use, you should use a computer (a PC, Laptop or similar) and one of the following:

- The **web interface**. A built-in web interface for easy configuration and daily use. The web interface is accessed from a computer connected to the EXPLORER 500, using an Internet browser. No installation of software is needed if you connect using LAN. If you connect using USB you need to install a USB driver for the computer to recognize the EXPLORER 500. See *Using the USB interface* on page 67.
For further information on the web interface, see Chapter 5, *Using the web interface*.
- The **BGAN LaunchPad** from Inmarsat. BGAN LaunchPad is a computer application used to control terminals in the BGAN system. LaunchPad is provided on the Inmarsat BGAN CD-ROM supplied with your EXPLORER 500. For information on how to use the LaunchPad, refer to the manual on the Inmarsat CD-ROM.

Additionally, it is possible to control the EXPLORER 500 using AT Commands. Refer to Appendix B, *AT commands*.

Antenna

The white part of the EXPLORER 500 is the antenna module. The antenna module comprises a GPS (Global Positioning System) antenna, a BGAN antenna and a Bluetooth antenna.

Compass

The EXPLORER 500 also provides a compass to help positioning the antenna. For further information on how to use the compass, see *Pointing the antenna* on page 21.



Battery

The EXPLORER 500 comes with a rechargeable battery, which is easily inserted. The battery is automatically recharged when power is applied to the EXPLORER 500. Steady green light indicates that the battery is charging.

SIM card

The SIM (Subscriber Identity Module) card used for the EXPLORER 500 is a standard SIM card, which is acquired from the Airtime Provider.

The EXPLORER 500 requires a SIM card to go online and to access the settings of the EXPLORER 500. Without a SIM card you can only see the Main screen of the display system showing battery status etc. Using the web interface, you can view the Dashboard of the EXPLORER 500 and upload software without inserting a SIM card. Upload of software, however, requires an Administrator user name and password.

SIM lock

The supplier may SIM lock the EXPLORER 500 to a specific provider. For further information, contact your supplier.

Matrix of services and communication interfaces

The following table shows which services can be accessed from which interfaces, and which types of equipment can be used.

Service		Interface on the EXPLORER 500				
		Phone/Fax	Bluetooth	USB	LAN	Display/Keypad
Circuit Switched Connection	3.1 kHz Audio	Analog telephone	Bluetooth handset			
		G3 Fax machine				
		Computer with analog modem				
Circuit Switched Connection	Standard Voice	Analog telephone	Bluetooth handset			
	Data		Computer	Computer (56 kbps/64 kbps)		
Packet Switched Connection	Data multi-user		Computer		Computer with Switch/Hub	
	Data single-user		Computer	Computer	Computer	
SMS			Computer	Computer	Computer	View only

What's next?

This chapter has provided an overview of the BGAN system and of the EXPLORER 500.

The next chapters will go into more detail about how to set up and use the EXPLORER 500. The following chapter, *Getting started*, explains how to unpack and start up the EXPLORER 500, and how to point the antenna in order to get the best possible signal.

Getting started

In this chapter

This chapter describes:

- what is included in the delivery,
- how to insert and remove the battery and SIM card, and
- how to start up the EXPLORER 500 and make the first call or data session.

Unpacking and assembling

Unpacking

Unpack the EXPLORER 500 and accessories and check that the following items are present:



EXPLORER 500



Getting Started Kit
containing:

- Getting Started leaflet
- Quick Guide
- EXPLORER 500 CD-ROM
- BGAN LaunchPad CD-ROM



AC/DC adapter



USB Cable



EXPLORER 500 Battery



LAN Cable

Inserting the SIM card

The EXPLORER 500 is delivered with the battery separated from the terminal. If the battery is already inserted, remove it as described in *Removing the battery* on page 13.

The SIM card is provided by your Airtime Provider. Insert the SIM card as follows:

1. Insert the SIM card into the SIM slot. Make sure the SIM card is positioned as shown!
2. Press gently until it clicks.

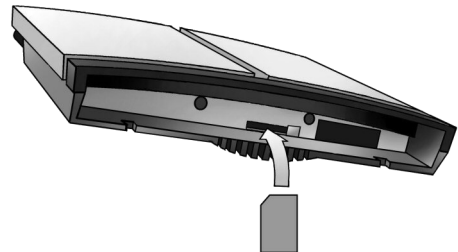

3. Slide the lock to close the SIM slot.

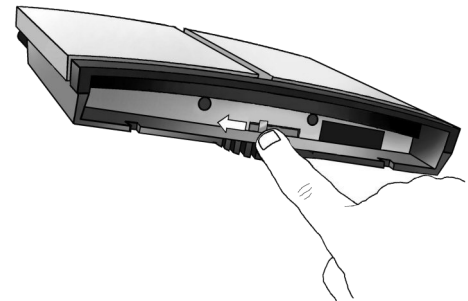

Inserting the battery

Do as follows:

1. Insert the battery.
Make sure the battery is positioned correctly as shown.
2. Press gently until it locks.

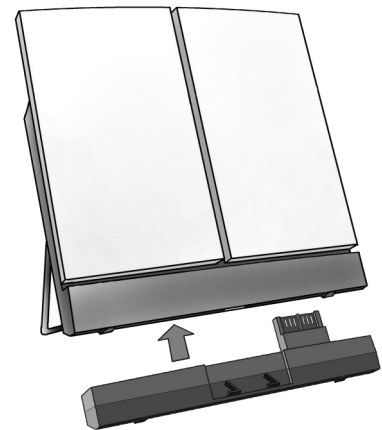

Note

Before using the terminal the first time: To ensure accurate information on the battery capacity you should fully charge, then fully discharge the battery (until the EXPLORER 500 closes down automatically), and finally recharge the battery. The EXPLORER 500 can be used during the discharging process, but the remaining battery capacity may not be displayed correctly. For information on how to recharge the battery, see *Recharging the battery* on page 139.

Removing the battery

To remove the battery, do as follows:

1. Locate the slide lock at the bottom of the unit.
2. Slide the lock aside to release the battery from the unit.

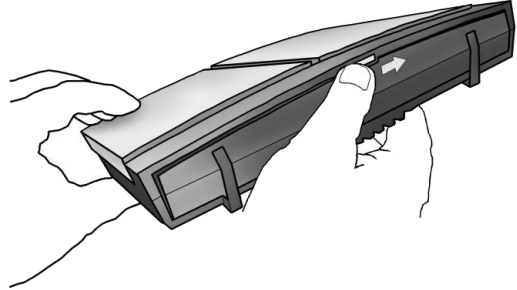

3. Remove the battery.

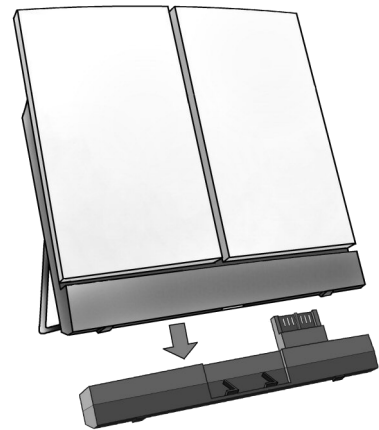

Removing the SIM card

To remove the SIM card, first remove the battery as described in *Removing the battery* on page 13.

Note

When the SIM card is removed, you cannot use the display menu system nor make calls or start data sessions.

Only emergency calls are allowed, and only if permitted by the network.

However, if you have an administrator user name and password, you can upload software using the web interface. For further information, see *Uploading software* on page 121.

Remove the SIM card as follows:

1. Slide the lock aside to open the SIM slot as shown.

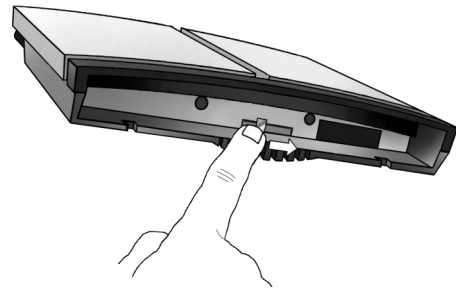

2. Gently press the SIM card and let it pop out of the slot.

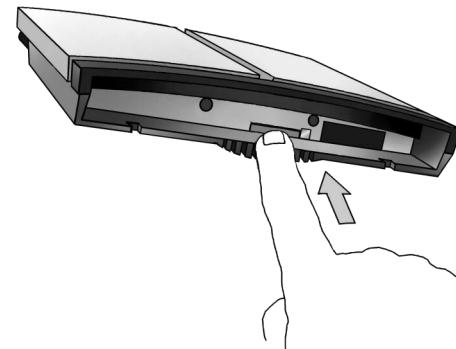

3. Remove the SIM card.

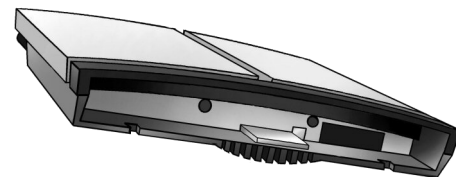

Placing the EXPLORER® 500

Please observe the following rules when placing the EXPLORER 500:

- When the battery is not inserted, use a dummy battery to protect the terminal. See *Options and accessories* on page 141.
- Place the EXPLORER 500 with the battery facing down.
- Place the EXPLORER 500 so that water, e.g. from rain, is led away from the terminal. The EXPLORER 500 is protected against splashing water and dust (IP-54) but is not water-proof. It must under no circumstances be submerged into water.

Connecting cables

After inserting SIM card and battery, connect all relevant cables.

Important | Connect the cables before making the final adjustment of the antenna position. Otherwise you may accidentally move the antenna when you connect the cables.

Side connector panel

The connector panel is placed on the side of the EXPLORER 500 and has the following connectors:

- USB connector for data equipment
- Phone/fax connector for phone, fax or analog modem
- LAN connector for data equipment
- DC Power connector (10-16 V DC) for connection to a 100-240 V AC/DC adapter, or to a charger cable which connects to the cigarette lighter socket/12 V DC in a car.

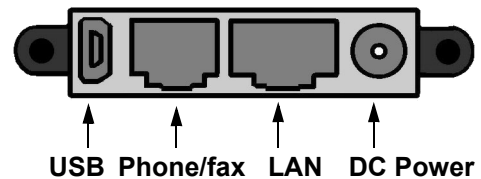

For information on how to connect to a specific interface, see the corresponding section in Chapter 4, *Using the interfaces*. The end of this section describes how to connect to power.

Rear connectors

Apart from the connectors in the connector panel, the EXPLORER 500 has a connector placed on the rear side of the EXPLORER 500. This connector is marked DC OUT and is used for charging the **EXPLORER Bluetooth Handset**.



For information on how to connect to this interface, see *Additional interfaces* on page 73.

Before connecting to power

You can connect to external power or use the battery delivered with your EXPLORER 500.

Refer to *Power input* on page 157 for specifications and pin-out for the DC Power input.

If you are connecting to a 100-240 V AC electrical outlet, use the AC/DC adapter included with your EXPLORER 500.

Alternatively, you may connect to 12 V DC in a car.

Connecting to power

You can connect the DC input to power without the battery inserted.

If the battery is inserted when you apply power to the EXPLORER 500, the battery is automatically recharged.

Connecting to a 100-240 V AC electrical outlet: Connect the AC/DC adapter to the DC Power input on the side of the EXPLORER 500. Then connect the power cable between the 100-240 V AC electrical outlet and the AC/DC adapter.



Connecting to 12 V DC in a car: Connect the charger cable between the DC Power input of the EXPLORER 500 and the cigarette lighter socket in the car. A suitable charger cable is available from Thrane & Thrane.

Powering the EXPLORER[®] 500

Automatic power up

The default behavior of the EXPLORER 500 is to power up automatically when you connect the power cable. If you wish, you can change this power up mode, so that the EXPLORER 500 is only powered if the Power button is pressed.

For further information on power up mode, see *Setting the power up mode* on page 42 or *Power up behavior* on page 92.

Switching the EXPLORER[®] 500 on/off

To switch on the EXPLORER 500, push the Power button next to the display and hold it down until the green Power indicator lights up. It normally takes one or two seconds.

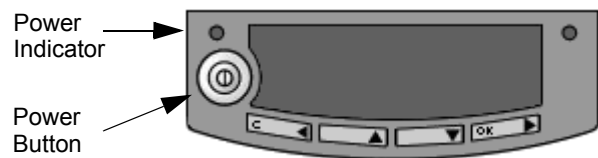

WARNING! If the EXPLORER 500 is configured to automatically accept pointing, stay clear of the antenna front after switching on the EXPLORER 500! The antenna emits radio frequency energy, **not only** when a call or data session is in progress, but as soon as the antenna pointing is completed. Always keep a minimum distance of 0.6 m from the antenna front when the antenna is pointed. For information on automatic pointing, see *Pointing at power up* on page 92.

After switching on the EXPLORER 500 you will be prompted for a PIN (Personal Identification Number), unless the PIN is disabled (e.g. using the BGAN LaunchPad).



For information on the options after power on, see the next section.

To switch off the EXPLORER 500, push the Power button again and hold it until the display shows **SWITCHING OFF . . .**

Options for the start-up procedure

Overview of the start-up options

You have different options for the start-up procedure. Each of these options are briefly described in this section.

For information on how to enter PIN and point the antenna, see the subsequent sections.

The following drawing shows the options available after power on.

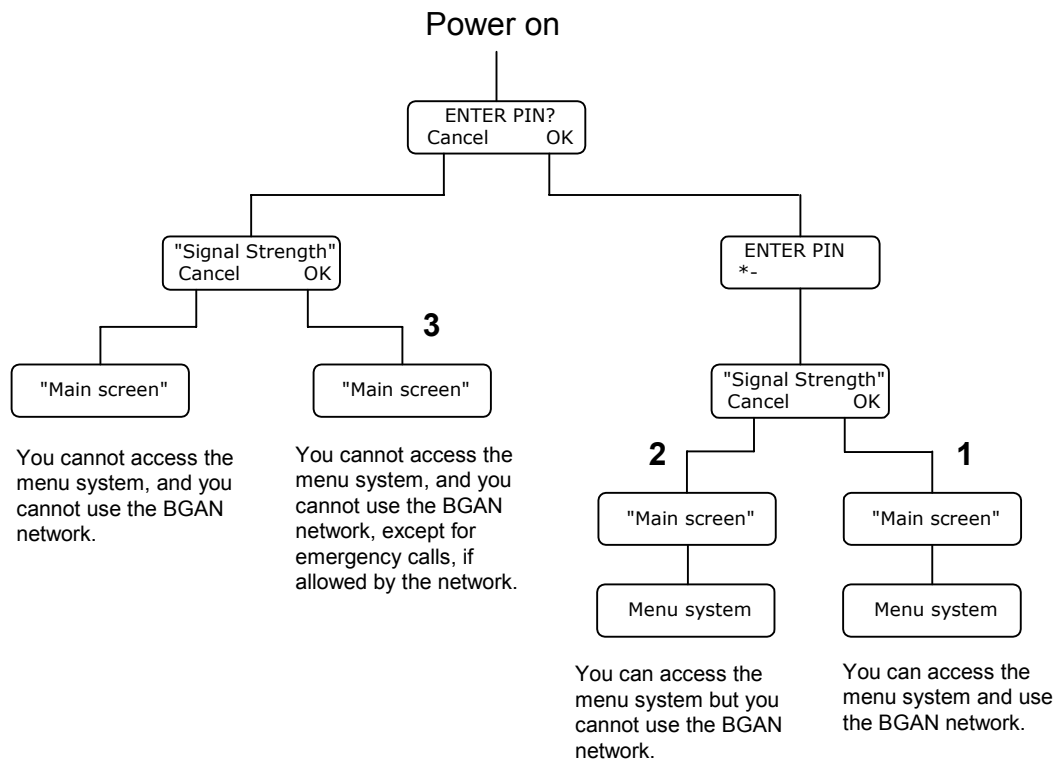

Note

If the use of PIN is disabled, e.g. from the BGAN LaunchPad, the display sequence is the same as after successfully entering the PIN. This means that after power on, you will see the Signal strength screen.

The numbers on the drawing refer to the different start-up options described in the following sections.

“Full” procedure (1)

After power on, enter the PIN and then point the antenna.

In this mode you have full access to the EXPLORER 500, that is you can use the menu system and communicate on the BGAN network.

The display will show `READY` when the menu system is not activated.

“Off-line” procedure (2)

After power on, enter the PIN, but cancel pointing.

In this mode you can use the menu system, but are not able to communicate on the BGAN network.

The display will show `POINT NOW?` when in the Main screen.

Press **▲** or **▼** to enter the menu system.

When you want to point the antenna, press **OK** from the Main screen.

“Emergency” procedure (3)

After power on, cancel the PIN and then point the antenna.

In this mode you can only place emergency calls, and only if permitted by the network. You are not able to access the menu system nor to communicate on the BGAN network (apart from emergency calls), until you enter the PIN.

The display will show `ENTER PIN?`

If you press **OK** you can enter the PIN. No other options are available from the keypad.

From the web interface you can view the Dashboard and, if you have an administrator password, upload software.

Entering the SIM PIN

Overview

You have to enter a PIN to use the EXPLORER 500, unless the use of PINs is disabled e.g. from the BGAN LaunchPad.

The first time you are asked for a PIN, you can choose to cancel (press **C**). If you cancel, you are asked again after pointing is completed. At that point you must enter the PIN to be able to continue.

Entering the PIN

Note If you want a different language in the display or in the web interface you may change the language after entering the PIN. For further information, see *Selecting the language* on page 42.

To enter the PIN using the display and keypad, do as follows:

1. When you are asked for a PIN, press **OK**.
2. Press **▲** or **▼** a number of times until the first digit is correct.
3. Press **OK** to go to the next digit.
When **OK** is pressed, the previous digit is indicated by a *****.



To correct an entered digit, press **C** to go back and use the **▲** and **▼** buttons again.

4. After entering the last digit with **OK**, press **OK** again to apply the PIN.

Note At this point the EXPLORER 500 may make a sound. This sound is used for pointing the antenna. To toggle the pointing sound on/off, press **▲** or **▼**.

For further information, see *Using the display and keypad* on page 31.

You can enter the PIN using a phone or computer connected to the EXPLORER 500. For further information, see *Entering the SIM PIN using a phone* on page 56 or *Entering the SIM PIN in the web interface* on page 78.

Wrong PIN

You have 3 attempts to enter the PIN, before you are asked to enter the PUK (Pin Unblocking Key). The PUK is supplied with your SIM card. Enter the PUK followed by a new PIN of your own choice. The PIN must be from 4 to 8 digits long.

Important If you enter a wrong PUK 10 times, the SIM card will no longer be functional, and you have to contact your Airtime Provider for a new SIM card.

Pointing the antenna

The importance of pointing

In order to obtain the best possible signal at the lowest possible cost, it is important that the EXPLORER 500 antenna is pointed correctly towards the satellite.

The antenna must have a clear line of sight to the satellite without any obstacles blocking the signal, and the pointing direction of the antenna should be as accurate as possible.

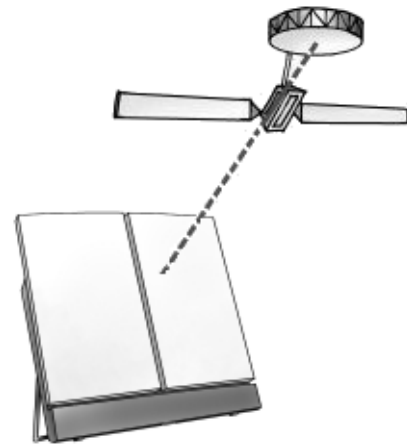

Important Incorrect pointing may result in poor quality of the signal, and in some cases retransmission may be necessary. This could mean you will be paying more than necessary for your transmission.

The next sections describe how to point the antenna for the best possible signal.

Pointing data

If the position of the satellite in relation to the EXPLORER 500 is known, you can use the compass to roughly point the antenna in the right direction. If you know the **Azimuth** and the **Elevation**, you can use this data to adjust the antenna.

- The **Azimuth** is the horizontal rotation angle relative to North (moving clockwise).

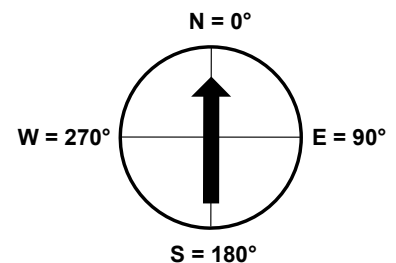

- The **Elevation** is the vertical rotation angle relative to horizontal. This means that an Elevation of 0° corresponds to the EXPLORER 500 being in an upright position, pointing towards the horizon.

The compass has 7 lines dividing the Elevation scale into 6 spaces. The space between two lines corresponds to 15° .

The Elevation is measured where the lines meet. This compass shows an Elevation of 30° (2 spaces up from the first line) and an Azimuth of 270° (antenna pointing towards West).

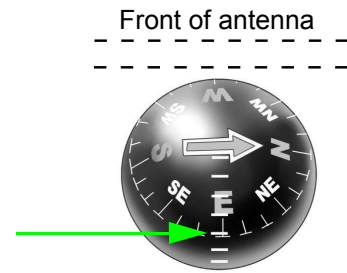

Note

The above explanation assumes that the compass shows the exact orientation. Please take into consideration the possible deviation and variation that can occur, e.g. because of the geographical location or the presence of magnetic objects.

Required signal strength

As a rule of thumb, the signal strength should typically be 45 dBHz or more for the EXPLORER 500 to be able to establish a call or data session. However, the required signal strength can vary depending on a number of factors, such as weather conditions and location.

Do not block the antenna signal with your hands

Important

When pointing the antenna, **do not touch** the front of the antenna module. If you place your fingers on the antenna you will be blocking the signal, and the antenna will not work efficiently.

Hold the support bracket and the battery module below the antenna while pointing.

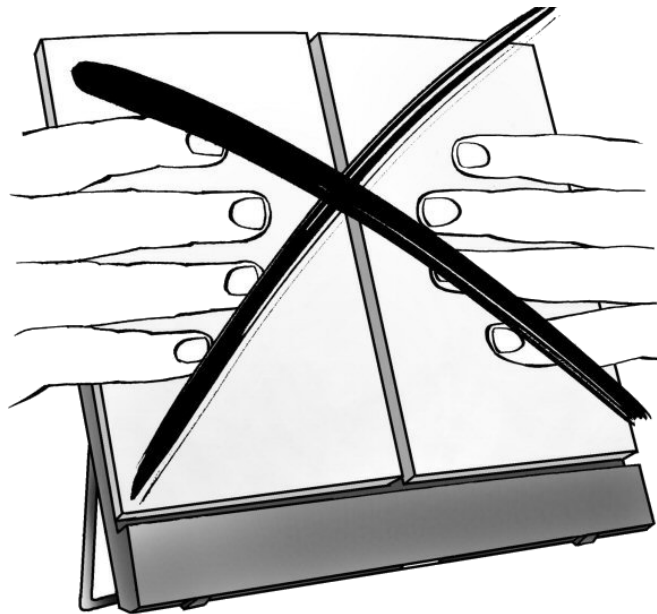

Obtaining a GPS fix

The EXPLORER 500 must acquire its own location from the GPS satellites before it can register on the BGAN network. This is called obtaining a GPS fix.

If the antenna is placed in an open location with a wide view to the sky, the EXPLORER 500 will probably obtain the GPS fix automatically while you are pointing towards the BGAN satellite. However, if part of the view to the sky is blocked, and/or the Elevation is very low, it may sometimes be difficult for the GPS antenna to “see” a sufficient number of GPS satellites.

The EXPLORER 500 can obtain the GPS position in two ways: Using the GPS antenna or using the BGAN I-4 antenna.

- If the terminal is placed in an open location with a wide view to the sky, the GPS antenna is the better choice, because it is omnidirectional.
- If, however, the terminal is placed in a location with a limited view e.g. close to a wall or similar, the I-4 antenna is better because it is directional.

For information on how to set up which antenna to use for acquiring GPS fix, see *Selecting the GPS antenna* on page 118 (only available in software version 1.07 and greater).

To ease the process of obtaining a GPS fix you may also try the following:

1. Place the antenna flat on an even surface, pointing straight upwards with a clear view to as much of the sky as possible.

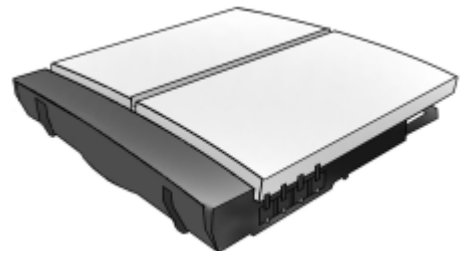

2. When the GPS fix is obtained, you can start pointing towards the BGAN satellite. To see the GPS status, enter the display menu system by pressing ▲ or ▼ and select **PROPERTIES > GPS STATUS**. For further information, see *Viewing the GPS status* on page 43.

Pointing the antenna towards the satellite

To help you obtain the best possible signal strength, the EXPLORER 500 uses a pointing sound to indicate the signal strength during pointing. The frequency of the tone increases with the signal strength.

You can toggle the pointing sound on/off by pressing ▲ or ▼ on the keypad.

Do as follows to point the antenna:

1. While observing the built-in compass of the EXPLORER 500, rotate the EXPLORER 500 left or right until it points in the correct horizontal direction, known as the **Azimuth**. Refer to *Pointing data* on page 21. Hold the battery module and the support bracket while moving the antenna. Do not place your hands on the antenna.

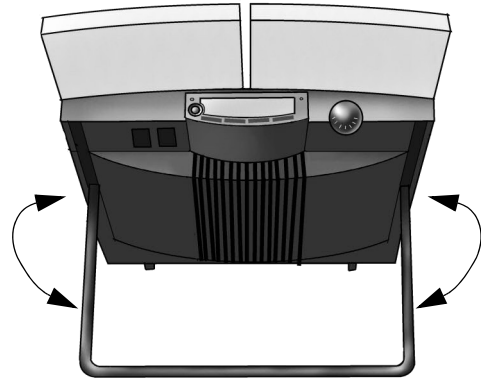

2. Tilt the EXPLORER 500 slowly up or down until it points in the correct vertical direction, known as the **Elevation**. Hold the battery module and the support bracket while moving the antenna. Do not place your hands on the antenna.

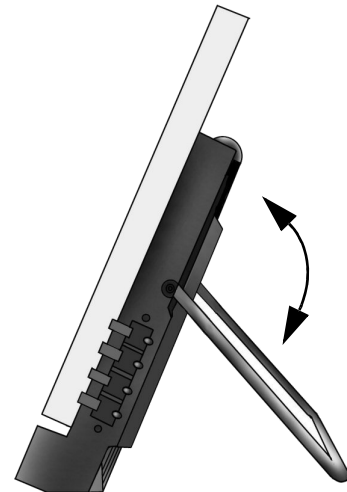

Note Make sure all cables are connected before fine adjusting the antenna position. If you connect cables after the final adjustment of the antenna position, you may accidentally move the antenna.

3. After passing the PIN screen, the display shows the current satellite signal strength. Use this information to fine-adjust the antenna position as shown in step 1 and 2.

Remember not to touch the antenna part!



Important When fine-adjusting the antenna, the display may take a while to update the signal strength. Wait a second or two after each move to make sure the display is updated.

If the right most part of the signal strength bar is grey, it indicates that the level has previously been higher than the current level.

4. When you have the highest signal strength you can obtain, press **OK** on the keypad.



WARNING! After accepting the signal strength, keep the minimum safety distance of 0.6 m to the antenna. The antenna may radiate microwave power as soon as the signal strength is accepted.

The EXPLORER 500 now tries to establish a connection to the BGAN network. The display shows the progress as follows:

- **SEARCHING:**
The EXPLORER 500 searches for the network operator. Note that the search procedure can be very short, so you may not see this text.
- **REGISTERING:**
The EXPLORER 500 is registering itself on the network.
If the GPS position has not yet been acquired at this point, the display may show **NO GPS**. For further information, see the *Troubleshooting Guide* on page 143.
- **READY or DATA:**
READY means the EXPLORER 500 is registered on the network and is ready to go online. If you have already connected a computer, the display shows **DATA** instead of **READY**.

Note

The display may show a different text than **READY** or **DATA** if there is more important information to show. For example, the display will show **ENTER PIN?** if you pressed **C** at the first request for a PIN. See also the *Troubleshooting Guide* on page 143.

CANCEL: If you press **C** instead of **OK**, you exit the pointing menu and the display shows the Main screen with the message **POINT NOW?**.

If the PIN has been accepted, you now have access to the menu system, but you will not be able to connect to the BGAN network, because the signal strength has not yet been accepted.

Using a fixed EXPLORER[®] 500 (semi-fixed installation)

You can keep the EXPLORER 500 in a fixed position, using the Pole mount kit for EXPLORER 500. See *Options and accessories* on page 141 for information on type number.

Note | The EXPLORER 500 is not suited for permanent outdoor installation.

Do as follows:

1. Mount the EXPLORER 500 on a pole or a wall, for example using the Pole mount kit. A size M6 thread fits into the mounting bush in the back of the EXPLORER 500.
2. Start up the EXPLORER 500 and point the antenna as described in *Pointing the antenna* on page 21.
3. Accept the signal strength by pressing **OK** on the EXPLORER 500 keypad.
4. Fasten the EXPLORER 500 in the pointed position.

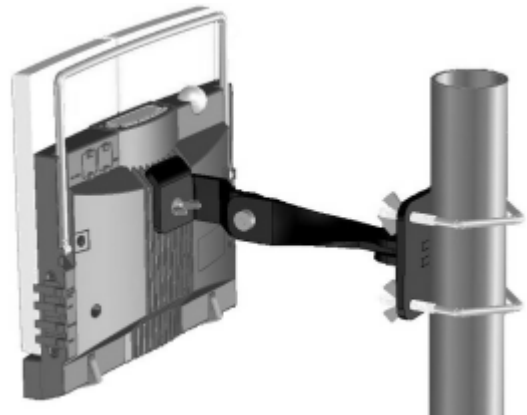

You only have to point the antenna once, when you mount it. Using a computer connected to the EXPLORER 500, you can set up the EXPLORER 500 to skip pointing at power up. Refer to *Pointing at power up* on page 92.

Making the first call

Introduction

After connecting cables, entering the PIN and pointing the antenna, you are ready to make or receive the first call.

The following sections provide a short guide to making calls. For more detailed information, see *Making or receiving a phone call with the EXPLORER® 500* on page 57.

Making a call from the EXPLORER® 500

Your phone must be connected to the relevant interface. For further information, see

- Standard phone: *Before connecting to the Phone/Fax interface* on page 54
- Bluetooth handset: *Pairing devices in which you can enter a passkey* on page 51.

To make a call from a phone connected to the EXPLORER 500, dial

00 <country code> <phone number> followed by **#** or off-hook key (**#** on analog phones, off-hook key on Bluetooth handsets).

Example: To call Thrane & Thrane in Denmark (+45 39558800) from an analog phone, dial **00 45 39558800 #**

Making a call to the EXPLORER® 500

To make a call to a phone connected to the EXPLORER 500, dial

+ <Mobile number>

- **+** is the prefix used in front of the country code for international calls. This is **00** when calling from most countries in Europe and from many other countries.
- **Mobile number:** The mobile number of the EXPLORER 500 you are calling. The first part of the mobile number is always 870, which is the “country code” for the BGAN system. For information on your mobile numbers, refer to your airtime subscription.

Note | There are two voice numbers, one for 3.1 kHz Audio and one for Standard Voice.

Example: If you are calling from Denmark and the mobile number for 3.1 kHz Audio is 870772112345 on your EXPLORER 500, and you want to make a call to the EXPLORER 500 using 3.1 kHz Audio, dial **00 870 772112345**.

Making a call from one EXPLORER® 500 to another EXPLORER 500

To make a call from one EXPLORER 500 to another EXPLORER 500, dial **00 <Mobile number>**.

Receiving a call

To be able to receive a call, the phone must be connected to the correct interface of the EXPLORER 500 (Phone/Fax or Bluetooth).

To be able to receive a call with a Bluetooth handset, the handset must be paired with the EXPLORER 500. For information on how to pair Bluetooth devices, see *Bluetooth pairing* on page 51.

Note | A connected phone will only ring if the call type is set correctly. For information on call types, see *Selecting the call type* on page 52.

You can see unanswered calls in the **CALLS** menu of the display and the web interface.

Making the first data connection (LAN)

Before connecting to the LAN interface

For the LAN (Local Area Network) interface to work without any further setup, the computer must be set up to obtain an IP address and a DNS server address automatically.

To check these settings on your computer, do as follows (For Windows® XP):

1. From the **Start** menu, select **Connect To > Show All Connections**.
2. Double-click **Local Area Connection** and click **Properties**.
3. Select **Internet Protocol (TCP/IP)** from the list and click **Properties**.
Make sure both fields are set to obtain an address automatically.

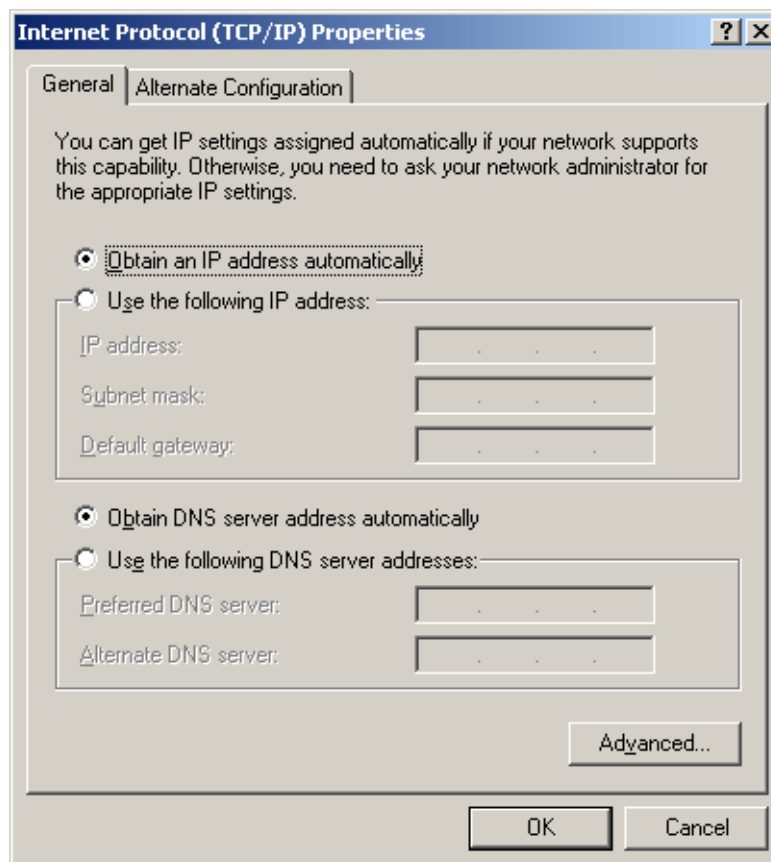

Connecting to the LAN interface

Do as follows:

1. Connect the LAN cable to the network interface of your computer.
A suitable cable is provided with your EXPLORER 500.

2. Connect the other end of the cable to the LAN connector on the EXPLORER 500.

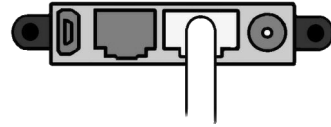

3. Start up and point the EXPLORER 500 as described earlier in this chapter.
4. Power on the computer.
5. When power up and pointing is completed, check the connection e.g. by starting your Internet Browser.
You may have to disable the Proxy server settings in your browser. For further information, see *Browser settings* on page 75.

What's next?

After reading this chapter you should be able to start up the EXPLORER 500 and make a simple data or voice connection.

The next chapters provide more information on the user interfaces and the setup of the EXPLORER 500. The following chapter, *Using the display and keypad*, explains the display menu system, which is the basic tool for setting up the EXPLORER 500.

Using the display and keypad

In this chapter

This chapter describes how to use the built-in display menu system of the EXPLORER 500.

It contains an overview of the entire menu system followed by a description of each menu.

It also explains the symbols and messages that may appear in the display, and describes how to navigate using the keypad.

Menu overview

Main menu

The items of the main menu are:

- **MESSAGES**
shows all incoming SMS messages and allows you to open or delete each message or delete all messages.
- **CONNECT**
shows a list of the Streaming profiles that are defined and selected for the LAN interface using the web interface. The **CONNECT** menu allows you to start and stop data sessions with the listed Streaming profiles.
- **CALLS**
shows missed, received and outgoing calls and data sessions.
- **SETTINGS** allows you to
 - restart the pointing procedure,
 - set display backlight and contrast,
 - set audio indications on or off,
 - enable or disable each interface,
 - enable or disable stealth mode (a terminal mode where lights and sound are off),
 - set the power up mode,
 - set the language used in the display and the web interface, and
 - restore settings.
- **PROPERTIES** shows:
 - known and accepted Bluetooth devices,
 - GPS status,
 - terminal information (IP address, hardware and software numbers, IMEI number),
 - mobile numbers
 - Voice mail number, and
 - a list of active alarms.

- **HELP DESK**
shows the phone number to the Airtime Provider, if available.

For information on how to navigate in the menu system, see *Navigating the display and keypad* on page 35.

Menu drawing

The below drawing shows an overview of the menus in the display menu system of the EXPLORER 500.

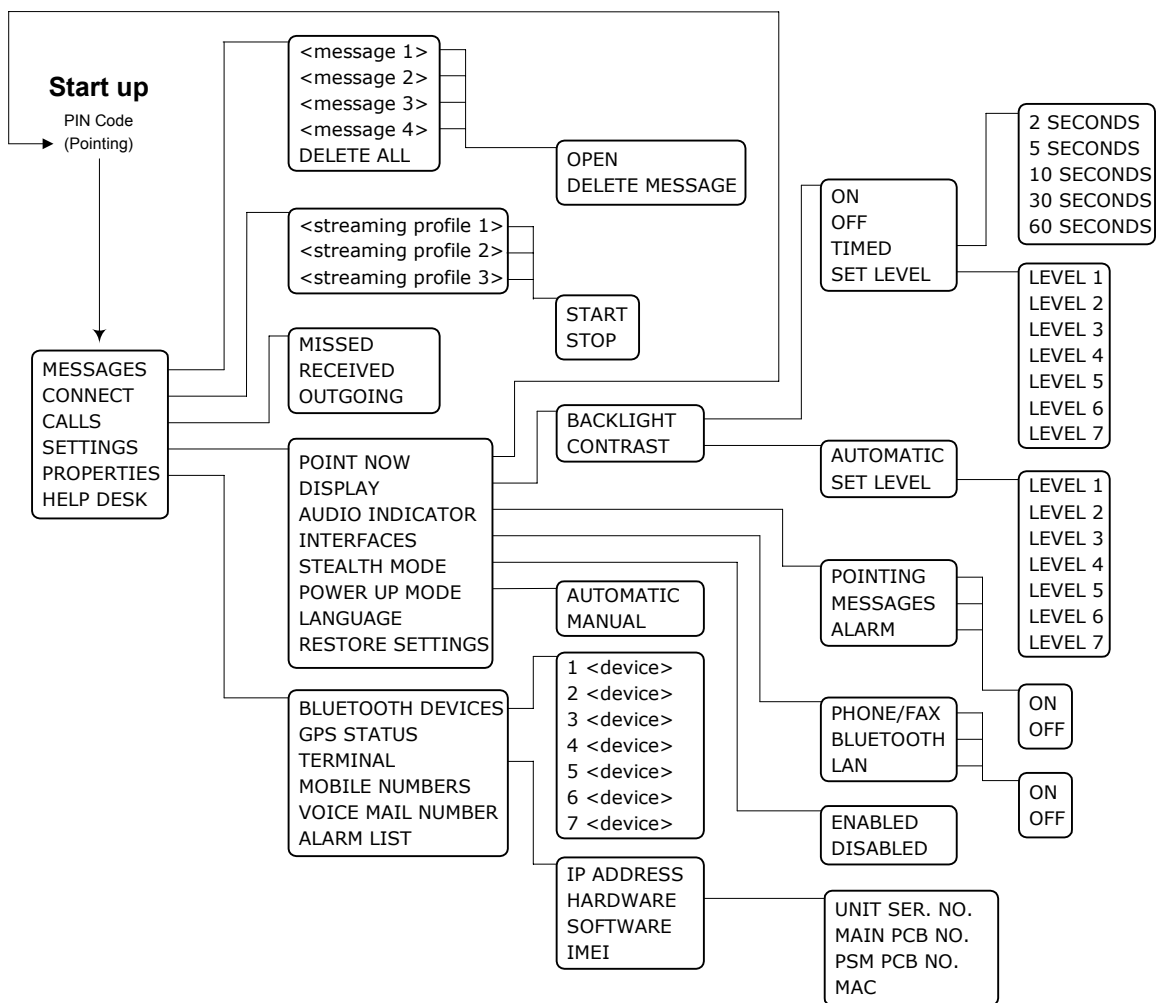

The next section shows an overview of the start-up sequence before entering the menu system. The menus are further described in the following sections of this chapter.

Display during start-up

Start-up sequence

There are different options for the start-up procedure. The complete startup procedure is described in Chapter 2, *Getting started*.

This section only describes the behavior of the display during normal startup.

After power on you are asked for a PIN.



When you press OK and enter PIN, the signal strength screen appears.



When you have pointed the antenna and pressed OK to accept the signal strength, the display shows the progress in the Main screen as follows:

- **SEARCHING:** The EXPLORER 500 is searching for the network operator.
- **REGISTERING:** The EXPLORER 500 is registering itself on the BGAN network. If the GPS position has not yet been acquired at this point, the display will show **NO GPS**. For further information, see the *Troubleshooting Guide* on page 143.
- **READY:** The EXPLORER 500 is registered on the network and is ready to go online. If a computer is already connected, the display will show **DATA** instead of **READY**.

Main screen

The Main screen is shown after passing the PIN and pointing screens, and anytime you leave the menu system.











The Main screen shows the most important status of the EXPLORER 500 such as battery status, signal strength, and general status.



The Main screen also shows icons for any interfaces that are turned on. In this example, all interfaces (Phone/Fax, Bluetooth, USB and LAN) are turned on.

Display symbols

Apart from the menu text, the display can show various symbols. Below is a list of the possible symbols with an explanation to each symbol.

Symbol	Explanation
	The battery charge level. When the level is too low (below 10%) the icon flashes. Recharge the battery as soon as possible. If no battery is inserted, the symbol is not shown in the display.
	The battery is charging.
	The signal strength. Minimum two bars are normally required to be able to make a Standard Voice call.
	Phone/Fax interface is on.
	Bluetooth interface is on.
	LAN interface is on.
	USB interface is on.
	Unread message (shown next to the message in the message list)
	Read messages (shown next to the message in the message list)
	The current connection on the BGAN network is not ciphered. Do not transmit data that requires ciphering.

Navigating the display and keypad

Navigating with the keypad

The PIN must be entered before you can access the menu system.

Note In low temperatures the display may respond slowly when a key is pressed. At temperatures close to -25°C/-13°F the display may even turn black for a moment, e.g. when you are scrolling through a menu. After 1-2 seconds with no keypad activity the display will be readable again.



- **To access the menu system from the Main screen**, press ▲ or ▼.
- **To move up and down in the current menu**, press ▲ or ▼.
- **To select the current menu item or setting**, press **OK**.
- **To escape the current menu/setting** and return to the previous level, press **C**.
- **To see the hidden part of long text strings**, press ►.
- **To move backwards in the menu system, or in long text strings**, press ◀.
- **To adjust settings**, press ▲ and ▼.

Short-cuts

The following short-cuts are available in the menu system:

- **To exit the menu system**, press and hold **C** for one second. The display returns to the Main screen.
- **To activate/deactivate Stealth mode**, Press **C+OK**. When stealth mode is activated, the display shows **STEALTH ACTIVATED** for a moment; then all lights and sounds are turned off.

Note For Stealth mode to be available, it must be enabled in the EXPLORER 500. Refer to *Enabling or disabling stealth mode* on page 41.

- **To turn Pointing sound on/off**, Press ▲ or ▼ from the pointing screen.

This action only applies to the current pointing session. To turn the sound on or off for all pointing sessions, select

SETTINGS > AUDIO INDICATORS > POINTING and select **ON** or **OFF**.

Display text

When you have not entered the menu system, the Main screen shows the currently most important information. Refer to *Dynamic information in the display* on page 46.

CANCEL in the left side of the display means: Press **C** to cancel the current operation.

OK in the right side of the display means: Press **OK** to accept the current operation.

The menus

The following sections describe each of the menus in the menu system.

All available settings and status items are explained.

To access the menu system from the main screen, press ▲ or ▼.





Messages menu

Viewing the list of messages

To see the list of SMS messages, enter the menu system and select **MESSAGES**.

Each message is listed with the name (if known) or the number of the sender.

An unopened folder  indicates an unread message and an opened folder  indicates a read message.

Use ▲ and ▼ to scroll through the list.

For information on how new messages are presented, see *Received messages* on page 46.

Opening or deleting received SMS messages

To delete all messages, go to the bottom of the list of messages and select **DELETE ALL**.

To open or delete one message, do as follows:

1. In the **MESSAGES** list, select the message you want to open or delete and press **OK**.
2. Then select one of the following:
 - **OPEN**: to open the selected message.
The display shows the time and the message contents. Use ▲ and ▼ to scroll through the message and details.
 - **DELETE**: to delete the selected message.

Connect menu

Streaming profiles

Using the web interface you can define a number of profiles for data transmission. The Streaming profiles defined and selected for the LAN interface appear in the **CONNECT** menu, and can be started and stopped using the keypad.

Streaming profiles are profiles where the Traffic Class is set to Streaming in the Profiles window of the web interface.

For information on profiles, see *Using Profiles* on page 130.

For information on Streaming, see *Standard or Streaming data* on page 64.

Starting or stopping a Streaming session

To start or stop a Streaming session using the LAN interface, do as follows:

1. Select **CONNECT**.
2. Select the Streaming profile you want to start or stop.
The list only shows profiles that have been selected for the LAN interface.
For information on how to set up the LAN interface, see *Configuring the LAN interface* on page 99.
3. Select **START** or **STOP** and confirm.

Important

When running a Streaming session you are charged for the time you are connected. An active Streaming session will stay active until you stop it.

You can also start/stop Streaming sessions using the web interface. For further information, see *Setting up and activating a Streaming connection* on page 64.

Starting or stopping a Standard data session

When the primary profile selected for the LAN interface uses Standard data, the default behavior of the EXPLORER 500 is to start Standard data automatically as soon as the EXPLORER 500 is online and the LAN cable is connected.

To change this behavior you can disable automatic activation of the primary profile, using the web interface. See *Configuring the LAN interface* on page 99.

When automatic activation is disabled, you can manually start/stop a Standard data session using the web interface or the display menu system.

To start or stop a Standard data session using the display menus, do as follows:

1. Select **CONNECT**.
2. Select the Standard profile you want to start or stop.
The list only shows profiles that have been selected for the LAN interface.

For information on how to set up the LAN interface, see *Configuring the LAN interface* on page 99.

3. Select **START** or **STOP** and confirm.

Calls menu

To see a list of calls and data sessions, do as follows:

1. Select **CALLS**.
2. Select one of the following:
 - **MISSED**: to see a list of incoming calls that were not answered.
 - **RECEIVED**: to see a list of incoming calls that were answered.
 - **OUTGOING**: to see a list of outgoing calls or data sessions.

Note | Local calls are not registered.

3. Select a call from the list to see details such as time, date and phone number.
If there was an error, the call log shows the cause of the error when possible.

When there are more than 100 calls in the list, the oldest calls are automatically deleted to make room for new calls.

If you need to preserve the call log, you can export it to a file using the built-in web interface. For further information, see *Exporting the call log* on page 84.

Settings menu

Point now

Important | This function will interrupt any ongoing calls or sessions!

If you need to repoint the antenna, select **SETTINGS > POINT NOW**.

This will bring you to the Pointing screen, described in *Pointing the antenna towards the satellite* on page 24.

Setting the display backlight

To adjust the backlight of the display, do as follows:

1. Select **SETTINGS > DISPLAY > BACKLIGHT**.
2. Select one of the following:
 - **ON**: to have constant backlight.
 - **OFF**: to turn the backlight off.
 - **TIMED**: to set how long the light should be on after the last key was pressed (2, 5, 10, 30 or 60 seconds).
 - **SET LEVEL**: to set the level of backlight (1 to 7).

Setting the display contrast

To adjust the contrast of the display, do as follows:

1. Select **SETTINGS > DISPLAY > CONTRAST**.
2. Select one of the following:
 - **AUTOMATIC**: to let the EXPLORER 500 automatically adjust the contrast according to the temperature.
The contrast of the display is affected by the temperature. The EXPLORER 500 can automatically adjust the contrast so that the display looks the same, regardless of changes in the temperature.
 - **SET LEVEL**: to set the contrast manually (1 to 7).

Turning audio indicators on or off

The EXPLORER 500 has audio indicators to indicate an event. You can turn each of these audio indicators on or off.

1. Select **SETTINGS > AUDIO INDICATOR**.
2. Select one of the following:
 - **POINTING**: a sound to indicate the signal level during pointing.
 - **MESSAGES**: a sound to indicate that a message has arrived.
 - **ALARM**: a sound to indicate that an alarm is present.
3. Select **ON** or **OFF** to enable or disable the selected audio indicator.

Enabling or disabling interfaces

Each interface (except USB) can be disabled to minimize the power consumption. Specially if the EXPLORER 500 is battery powered, it is a good idea to disable unused interfaces.

Note | Your user permissions may not allow access to all interfaces. Blocked interfaces are greyed out.

Do as follows:

1. Select **SETTINGS > INTERFACES**.
2. Select one of the following interfaces:
 - **PHONE/FAX**
 - **BLUETOOTH**
 - **LAN**
3. Select **ON** or **OFF** to enable or disable the selected interface.

Enabling or disabling stealth mode

When the EXPLORER 500 is in stealth mode, all lights and sounds are turned off. You can still use the EXPLORER 500, and the display text is readable.

To enable or disable the use of stealth mode, do as follows:

1. Select **SETTINGS > STEALTH MODE**.
2. Select one of the following:
 - **ENABLED**
 - **DISABLED**

Note | Enabling stealth mode will **not put the EXPLORER 500 into stealth mode**, it only enables the use of stealth mode.

- To activate Stealth mode (after enabling Stealth mode), press **C+OK** on the keypad.
- To deactivate Stealth mode, press **C+OK** again.

Setting the power up mode

By default, the EXPLORER 500 starts up automatically when you apply external power. You can change this mode, so that you have to press the Power button to switch on the EXPLORER 500.

To set the power up mode, do as follows:

1. Select **SETTINGS > POWER UP MODE**.
2. Select one of the following:
 - **AUTOMATIC**: to have the EXPLORER 500 power on automatically when external power is applied.
 - **MANUAL**: to have the EXPLORER 500 power on only when the Power button is pressed.

Selecting the language

You can change the language used in the display and in the web interface for the EXPLORER 500. Do as follows:

1. Select **SETTINGS > LANGUAGE**.
2. Select the language you want to use. The following languages are available:
 - English
 - French
 - German
 - Russian
 - Spanish

The web interface and the display menus will now use the selected language.

Restoring settings

You can restore default values for the settings in the **SETTINGS** menu, except the contrast setting. The following settings are restored:

- Backlight
- Audio indicators
- Stealth mode
- Interfaces enabled
- Power up mode

Note that all other settings are left unchanged.

To restore settings, do as follows:

1. Select **SETTINGS > RESTORE SETTINGS**.
2. Press **OK**.

Properties menu

Viewing known Bluetooth devices

You can view a list of the Bluetooth devices that are paired with the EXPLORER 500. The devices are listed with their Bluetooth names.

The devices in this list can communicate with the EXPLORER 500 without any further setup.

To view the list of known Bluetooth devices, select **PROPERTIES > BLUETOOTH DEVICES**.

To see details on a specific Bluetooth device, select the device in the list and press **OK**.

Viewing the GPS status

The display can show the current GPS status.

To view the GPS status, select **PROPERTIES > GPS STATUS**.

The GPS status screen can vary, depending on the situation.

- If the GPS position has not yet been obtained, the display shows the status of each of the 16 GPS satellites as follows:
- If the GPS position is known, the display shows the GPS position, and whether it is a 2-dimensional or 3-dimensional position (2D fix or 3D fix).
- In some cases, the BGAN network does not allow the position to be displayed to the user. If this is the case, the display may just show **GPS ACQUIRED**. This means that the GPS position is received, but the user is not allowed to see it. This also applies if the EXPLORER 500 is not yet registered on the BGAN network, but the GPS position is received.



Viewing terminal properties

You can view properties of the EXPLORER 500 such as IP address, hardware numbers, software version and IMEI number. When contacting Support, please include these numbers.

To view the properties, do as follows:

1. Select **PROPERTIES > TERMINAL**.
2. Select one of the following options:
 - **IP ADDRESS** to see the IP address of the EXPLORER 500. This IP address is used to access the web interface in the EXPLORER 500. The web interface is a built-in web server used to configure and set up the EXPLORER 500. For further information on the web interface, see *Using the web interface* on page 74.
 - **HARDWARE** to see the serial number, PCB numbers and MAC address of your EXPLORER 500.
 - **SOFTWARE** to see the software version of the EXPLORER 500.
 - **IMEI** to see the IMEI number (International Mobile Equipment Identity) of the EXPLORER 500. This is the unique mobile equipment number that identifies your EXPLORER 500. The IMEI number is also printed on the serial number label at the back of the terminal.

Viewing mobile numbers

If available, the **MOBILE NUMBERS** menu lists the mobile numbers to use when calling the EXPLORER 500.

Note

There are two voice numbers, one for 3.1 kHz Audio and one for Standard Voice. For further information, see *Selecting the call type* on page 52.

To view the mobile numbers, select **PROPERTIES > MOBILE NUMBERS**.

If the mobile numbers are not available, the display reads
NO INFORMATION AVAILABLE.

Viewing the voice mail number

The EXPLORER 500 informs you of any incoming voice mail through the display and through the web interface.

The voice mail number is the number you call to hear your incoming voice mail. If available on the SIM card, the **PROPERTIES** menu shows the voice mail number.

To view the voice mail number, select
PROPERTIES > VOICE MAIL NUMBER.

If the voice mail number is not available, the display reads
NO INFORMATION AVAILABLE.

Alarm list

If an error is present in the system, an alarm will be issued. For information on how new alarms are presented, see *Display of alarm messages* on page 149.

To view the list of currently active alarms, enter the menu system and select **PROPERTIES > ALARM LIST**.

The alarms are listed with their ID numbers.

To see the name and time stamp of the alarm, press **OK**.

Use ▲ and ▼ to scroll through the name, ID and time stamp. If the text is too long, press **OK (▶)** to scroll through the rest of the text.

Help desk

If you need support **regarding airtime**, you may call the Airtime Provider help desk.

To see the help desk number, select **HELP DESK** in the menu system.

The display will show the name and phone number of your Airtime Provider, if it is available on the SIM card.

If the information is not available on the SIM card, you can use the built-in web interface of the EXPLORER 500 to store the help desk name and number. For further information, see *Accessing the Help desk* on page 136.

Dynamic information in the display

Types of display information

Text in the display can be:

- Information of received messages.
- Alarms.
- Status information.
- Request for action.

Received messages

When messages arrive in your EXPLORER 500, the display indicates the number of new messages that have arrived, and the red message indicator is flashing.



The messages can be SMS messages or notification of voice mail.

- **If the message is an SMS message**, press **OK** to view the message.
- **If the message is information of voice mail**, press **OK** or **C** to go back to the Main screen. The red message indicator will keep flashing until you have collected your voice mail.
- To hear your voice mail, call the voice mail service number provided by your Airtime Provider.
- To see the voice mail service number, select **PROPERTIES > VOICE MAIL NUMBER**

Alarms

When alarms are issued in your EXPLORER 500, the display indicates the number of new alarms, and the red message indicator is flashing.



To view currently active alarms, press **OK**. To ignore and continue, press **C**.

See also:

- *Display of alarm messages* on page 149.
- *Alarm log* on page 154.
- *List of alarms* on page 150.

Status information

Status information in the display is normally shown in the lower line of the Main screen.

Examples of status information are: **READY**, **REGISTERING** and **DATA**.

Displaying ongoing transmission

The display shows information on type and duration/MB for calls and data sessions in progress.

- A 64 K Streaming session is displayed as **64K** followed by the duration,
- a CS call is displayed as **CALL** followed by the duration and
- Background data is displayed as **DATA** followed by MB.

Two lines are available in the display. If more than two calls or sessions are active, display of Streaming data has the highest priority, then CS calls and then Background data. Within these categories, the oldest calls/data sessions have the highest priority.



WARNING! When the EXPLORER 500 is pointed, stay clear of the antenna front! The antenna emits radio frequency energy, **not only** when a call or data session is in progress, but as soon as the antenna pointing is completed. Always keep a minimum distance of 0.6 m from the antenna front when the antenna is pointed.

Request for action

A request for action, if it is not an alarm, is shown in the lower line of the display. This could be e.g. **POINT NOW?** or **INSERT SIM**.

When the text is a question, press **OK** to accept.

What's next?

This chapter has explained how to navigate in the display menu system and how to use it for basic setup of the EXPLORER 500.

The following chapter, *Using the interfaces*, explains in detail how to set up and use each interface of the EXPLORER 500.

Using the interfaces

In this chapter

This chapter describes how to use the interfaces of the EXPLORER 500. For each connection type it describes how to connect cables and the necessary setup to establish a connection.

It does not describe advanced configuration of interfaces. For this type of information, refer to the “Configuring...” sections for the data interfaces in Chapter 5, *Using the web interface*.

General

Tools for setup and use

Overview

The display and keypad can be used for simple setup, but for enhanced use and for configuration of interfaces, you need to connect a computer (PC, laptop or similar).

With a computer and a browser, you can use the following to set up the EXPLORER 500:

- The built-in **web interface** of the EXPLORER 500
- The **BGAN LaunchPad**

The web interface in the EXPLORER® 500

The web interface is a built-in web server for setting up and controlling the EXPLORER 500, using a connected computer with a browser. No installation of software is required, unless the computer is connected via USB. For information on how to use the web interface, see *Using the web interface* on page 74.

The BGAN LaunchPad

BGAN LaunchPad from Inmarsat is a computer application for setting up terminals in the BGAN system. A CD-ROM with the LaunchPad is included in the delivery. For information on how to use the LaunchPad, refer to the user guide provided with the LaunchPad.

Services and interfaces

A variety of services can be accessed from different interfaces on the EXPLORER 500.

The following table shows the possible combinations of services and interfaces, and which types of equipment can be used.

Service		Interface on the EXPLORER 500				
		Phone/Fax	Bluetooth	USB	LAN	Display/Keypad
Circuit Switched Connection	3.1 kHz Audio	Analog telephone	Bluetooth handset			
		G3 Fax machine				
		Computer with analog modem				
	Standard Voice	Analog telephone	Bluetooth handset			
	Data		Computer	Computer (56 kbps/64 kbps)		
Packet Switched Connection	Data multi-user		Computer		Computer with Switch/Hub	
	Data single-user		Computer	Computer	Computer	

Enabling or disabling an interface

Overview

By default, all interfaces are enabled. However, you can disable the LAN interface, the Bluetooth interface and/or the Phone/Fax interface in order to minimize the power consumption.

Note | The USB interface cannot be disabled; it is always enabled.

Using display and keypad

To enable or disable an interface using the **display and keypad**, do as follows:

1. Enter the menu system.
From the Main screen, press ▲ or ▼.
2. Select **SETTINGS > INTERFACES**.
3. Select the interface you want to enable or disable.
4. Select **ON** to enable or **OFF** to disable.

Using web interface

To enable or disable an interface using the **web interface**, do as follows:

1. Connect a computer. Refer to the relevant section in this chapter, e.g. *Connecting to the LAN interface* on page 66.
2. Access the web interface.
For further information, see *The web interface* on page 74.
3. From the left navigation pane in the web interface, select **SETTINGS** and select the interface you want to enable or disable.
4. Select **Enabled** or **Disabled** at the top of the window.

Bluetooth pairing

What is pairing?

Bluetooth Pairing happens when two Bluetooth enabled devices agree to communicate with one another. When this happens, the two devices exchange passkeys and join a pair. The pairing process only takes place the first time the two devices are connected. Once the two devices have established a pair, they automatically accept communication when one device recognizes the other device.

Pairing devices in which you can enter a passkey

This section describes how to pair devices in which you can enter a passkey.

Note | The method for pairing devices may vary depending on your Bluetooth device. Consult your Bluetooth device documentation for information.

For information on pairing devices with a fixed passkey from your EXPLORER 500, see *Pairing Bluetooth devices from the web interface* on page 107.

The following procedure presupposes that the EXPLORER 500 is configured to be visible to other Bluetooth devices, and that the Bluetooth interface is turned on. For information on configuration, see *Configuring the Bluetooth interface* on page 104.

Do as follows to pair the devices:

1. Start up the EXPLORER 500.
For further information, see *Getting started* on page 11.
2. Turn on Bluetooth on your Bluetooth device and place it close to the EXPLORER 500.
3. On your Bluetooth device, search for new devices and select the EXPLORER 500 when it is found.
The default Bluetooth name of the EXPLORER 500 is **EXPLORER 500**.
If there is more than one EXPLORER 500 in the list, you can use the MAC address to locate the correct one. To see the MAC address of your EXPLORER 500, enter the display menu system and select **PROPERTIES > TERMINAL > HARDWARE > MAC**.
4. On your Bluetooth device, enter the passkey of your EXPLORER 500.
The default passkey is the serial number of your EXPLORER 500. To see the serial number, look at the label on the back of your EXPLORER 500, or enter the menu system and select **PROPERTIES > TERMINAL > HARDWARE > UNIT SER. NO.**

The new device is now paired and ready to communicate with the EXPLORER 500.

Note | Maximum 7 devices can be paired with the EXPLORER 500. If you have already paired 7 devices you have to unpair a device before you can pair a new one. For information on how to unpair devices, see *Unpairing devices* on page 109.

Using a phone or fax machine

Selecting the call type

Definition

The phone connection can be either a **Standard Voice** connection or a **3.1 kHz Audio** connection. In the web interface you can set up which type of connection to use by default when you make or receive a call from the Phone/Fax or Bluetooth interface.

When connecting a fax or a modem you must use 3.1 kHz Audio.

Example: If you always have a fax connected to the Phone/Fax interface you can set this interface to 3.1 kHz Audio only. This will mean that if an incoming Standard Voice call is received, the Phone/Fax interface will not ring.

Selecting the default outgoing call type

To select the default call type for outgoing calls, first connect a computer. Refer to the relevant section in this chapter, e.g. *Connecting to the LAN interface* on page 66.

Then do as follows:

1. Access the web interface. See *The web interface* on page 74.
2. From the left navigation pane, select **SETTINGS** and select **Phone/Fax** or **Bluetooth**.
3. At **Outgoing calls**, select **Standard** or **3.1 kHz Audio**.
Up to 7 Bluetooth devices can be paired with the EXPLORER 500. Remember to set the call type for each paired handset in the **BLUETOOTH VOICE DEVICES** list.

Overriding the default outgoing call type

To override the default setting for a specific outgoing call, do as follows:

- To use **Standard Voice** for the call, dial **1*** before the number.
- To use **3.1 kHz Audio** for the call, dial **2*** before the number.

Example: To make a call to Thrane & Thrane in Denmark (+45 39558800), forcing the connection to use Standard Voice, dial **1* 0045 39558800** followed by **#** if calling from an analog phone, or off-hook key if calling from a Bluetooth handset.

Note

This will not change the default call type, only the type used for the ongoing call.

Phone numbers for incoming 3.1 kHz Audio and Standard Voice

3.1 kHz Audio and Standard Voice have separate phone numbers. This way, a person calling a phone connected to the EXPLORER 500 can select whether to use 3.1 kHz Audio or Standard Voice, simply by using one of the two phone numbers.

Note

The call type you are using must be selected in the web interface (refer to the next section).

For information on the mobile numbers, refer to your airtime subscription.

For information on how to make a call to the EXPLORER 500, see *Making a call to the EXPLORER® 500* on page 58.

Selecting the incoming call type

To select which call types are accepted for an incoming call, first connect a computer. Refer to the relevant section in this chapter, e.g. *Connecting to the LAN interface* on page 66.

Then do as follows:

1. Access the web interface.
For further information, see *The web interface* on page 74.
2. From the left navigation pane, select **SETTINGS** and select **Phone/Fax** or **Bluetooth**.
3. At **Incoming Calls**, check **Standard** or **3.1 kHz Audio** or both. For Bluetooth, remember to set the call type for each handset in the **BLUETOOTH VOICE DEVICES** list.
If the call type used for a call to the EXPLORER 500 is not selected in the web interface, the connected phone will not ring.

Connecting an analog phone or a fax machine

Before connecting to the Phone/Fax interface

To connect a phone or a fax machine to the Phone/Fax connector, you need an analog telephone cable with an RJ-11 connector. For specifications and pin-out, refer to *Phone/Fax interface* on page 158.

Connecting to the Phone/Fax interface

Do as follows:

1. Connect the cable to your phone or fax machine.
2. Connect the other end of the cable to the Phone/Fax connector on the EXPLORER 500.
3. Power up the EXPLORER 500 and point the antenna as described in *Pointing the antenna* on page 21.
4. Check the connection by making a phone call or sending a fax.
See *Making or receiving a phone call with the EXPLORER® 500* on page 57 or *Sending or receiving a fax message* on page 62.

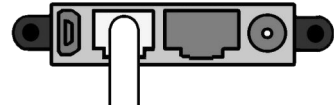

If connection fails, check that the interface is enabled in the EXPLORER 500.

If the analog phone icon is not present in the display Main screen and in the Icon bar of the web interface, the interface is disabled.

See *Enabling or disabling an interface* on page 50.

If the interface is enabled, but connection fails, refer to the *Troubleshooting Guide* on page 142.

Connecting a Bluetooth handset

Before connecting a Bluetooth handset

To use a Bluetooth handset with the EXPLORER 500, you first have to pair the two devices. For information on pairing devices, see *Bluetooth pairing* on page 51.

The Bluetooth handset must be placed within a maximum distance of 100 m from the EXPLORER 500. Note that this is the maximum distance in open air; the actual maximum distance may be shorter, depending on the environment. In an office environment, you should be able to establish a connection across the adjoining 2-3 rooms.

Connecting a paired Bluetooth handset

This section does not describe configuration of the Bluetooth interface. For information on configuration, see *Configuring the Bluetooth interface* on page 104.

If the devices are already paired, do as follows to connect:

1. Power up the handset and the EXPLORER 500.
2. Place the handset close to the EXPLORER 500.
3. Turn on Bluetooth on your device.
The Bluetooth connection should now be established, and you are ready to make a call.

Note | Maximum 7 devices can be connected at the same time.

If connection fails, check that the interface is enabled in the EXPLORER 500.

If the Bluetooth icon is not present in the display Main screen and in the Dashboard in the web interface, the interface is disabled.

See *Enabling or disabling an interface* on page 50.

If the interface is enabled, but connection fails, refer to the *Troubleshooting Guide* on page 146.

For information on how to make and receive calls, see *Making or receiving a phone call with the EXPLORER® 500* on page 57.

Entering the SIM PIN using a phone

Entering the PIN

If you have a phone connected to the EXPLORER 500, you can use it to enter the PIN at start up, as an alternative to the keypad.

Do as follows:

Dial the PIN the same way you would dial a phone number:

- **For an analog phone:**
Pick up the phone. When the EXPLORER 500 is waiting for a PIN, you will hear 2 beeps - pause - 2 beeps - etc.
Dial <PIN> followed by #.
- **For a Bluetooth handset:**
Dial <PIN> and press off hook key.

When you hear a “busy” tone or a dialing tone, the PIN has been accepted and you can hang up or dial a number.

Wrong PIN

If, instead of the busy tone or dialing tone, you continue to hear 2 beeps - pause - 2 beeps - etc., it means the PIN was wrong. Check that you have the correct PIN and try again.

If a wrong PIN has been entered three times, you will hear 3 beeps - pause - 3 beeps - etc. This means you have to enter the PUK (PIN Unblocking Key) provided with your SIM card. After entering the PUK, you must enter a new PIN of your own choice (4 to 8 digits long).

Dial the following:

<PUK> * <New PIN> * <New PIN> followed by # or off-hook key.

Example: If the PUK is 87654321 and the new PIN is 1234, dial

87654321 * 1234 * 1234 followed by # or off-hook key.

If you enter 10 wrong PUKs, the SIM card will no longer be functional. Contact your Airtime Provider for a new SIM card.

Making or receiving a phone call with the EXPLORER® 500

Analog phone or Bluetooth handset

First connect your phone to the relevant interface. For further information, see *Before connecting to the Phone/Fax interface* on page 54, or, for the Bluetooth handset, *Pairing devices in which you can enter a passkey* on page 51.

Note

There are different methods for activating a call, depending on the type of phone:

- **Analog phone:** Dial # after the number.
- **Bluetooth handset:** Press the off-hook key after the number.

Making a call

You have two methods for making a call:

- **Short Dial.** If the number is in the phone book of the EXPLORER 500, you can use the Short Dial number, which is found in the first column of the phone book in the web interface. See *Short dial* on page 83.

Simply dial **00 <Short Dial>** followed by **#** or off-hook key.

Example: To call entry number 4 in the phone book, dial **004** followed by **#** or off-hook key.

- **Manual Dial.** To make a call, dial **00 <country code> <phone number>** followed by **#** or off-hook key.

Example: To call Thrane & Thrane in Denmark (+45 39558800) from an analog phone, dial **00 45 39558800 #**

If there was an error establishing the connection, the web interface and the display of the EXPLORER 500 show an error message. Refer to the *Troubleshooting Guide* on page 145.

Receiving a call

To be able to receive a call, the phone must be connected to the relevant interface on the EXPLORER 500.

By default, all devices connected to the Phone/Fax interface or the Bluetooth interface will ring when one of the mobile numbers is called. Note, however, that this depends on the call type settings. Refer to *Selecting the incoming call type* on page 53.

Information of missed calls is stored in the call log of the EXPLORER 500. You can view the call log with the display menu system or the web interface. See *Calls menu* on page 39 or *Viewing the lists of calls* on page 85.

Making a call to the EXPLORER[®] 500

To make a call to a phone connected to the EXPLORER 500, dial

+ <Mobile number>

- + is the prefix used in front of the country code for international calls. This is **00** when calling from countries in Europe and from many other countries.
- **Mobile number.** The first part of the mobile number is always 870, which is the “country code” for the BGAN system. For information on the mobile numbers, refer to your airtime subscription.

Note | There are two Voice numbers, one for 3.1 kHz Audio and one for Standard Voice.

Dialing functions

Overview

There are a number of dialing functions available in the EXPLORER 500.

The following list shows the allocated special-purpose numbers for the EXPLORER 500.

Number	Function
0 * followed by # or off-hook key	Redial last called number on this interface.
00 * followed by # or off-hook key	Redial last answered call on this interface. Note: If the last answered number is an unlisted number, you will not be allowed to dial back.
00 followed by one of the numbers 1-199 and # or off-hook key	Short dial phone numbers in phone book.
0200 followed by # or off-hook key	Local call broadcast to all Bluetooth handsets. All connected Bluetooth handsets will ring. The first handset that answers, takes the call.
0 followed by one of the numbers 201-207 and #	Local call to Bluetooth handset.
0301 followed by # or off-hook key	Local call to analog phone.
0900 followed by # or off-hook key	Local call broadcast to all handsets.

Apart from the numbers above, the EXPLORER 500 uses the following dialing prefixes:

- **1*** before the phone number will force the connection to use **Standard Voice**.
- **2*** before the phone number will force the connection to use **3.1 kHz Audio**.
- **#31#** before the phone number will hide the callers phone number to the recipient.
- ***31#** before the phone number will show the callers phone number to the recipient where it would otherwise be hidden, e.g. because the number is an ex-directory number.
- **R** is used during a call to indicate that the following key-presses should activate a supplementary services function. The supplementary services functions supported by the EXPLORER 500 are described in the subsequent sections.

Making local phone calls

You can make local calls between phones connected to the EXPLORER 500.

Local phone numbers always start with 0.

For an overview of the numbers, see *Overview* on page 59.

To make a local call, dial

<**local number**> followed by **#** or off-hook key.

Note

You cannot make local calls between two Bluetooth handsets through the EXPLORER 500. You can only make local calls between an analog phone and a Bluetooth handset.

Up to 7 Bluetooth handsets can be connected at the same time, but **only one call** can be active on the Bluetooth interface.

You can look up the local Bluetooth phone numbers in the display or in the web interface as follows:

- **Display**
Enter the menu system and select **PROPERTIES > BLUETOOTH DEVICES**. The list shows all accepted Bluetooth devices with local number and Bluetooth name.
- **web interface**
Access the web interface and select **SETTINGS > Bluetooth > Paired Devices**.
The paired voice devices are listed with their local phone numbers.

Handling waiting calls

Note

The phone must have an R key to be able to use these functions.

The EXPLORER Bluetooth Handset uses a softkey in stead of the R key.

During a call, if a second party attempts to make contact with you, you may hear a Call Waiting indication. The Call Waiting indication is two beeps and a pause of 3 seconds, then two beeps again etc. If no action is taken, the waiting call is released after a time out period.

In the web interface you can enable or disable the call waiting indication. For further information, see *Call waiting* on page 114.

When you receive a Call Waiting indication, you have the following options:

If you want to:	Do as follows:
Clear the current call, and accept the waiting call.	Press R 1 # , within the time out period.
Hold the current call, and accept the waiting call.	Press R 2 # , within the time out period.
Ignore the waiting call.	Take no action.
Reject the waiting call.	Press R 0 # , within the time out period.

Holding a call

Note

The phone must have an R key to be able to use these functions.
The EXPLORER Bluetooth Handset uses a softkey in stead of the R key.

During a call, you may place the initial call on hold while another call is made.

If you want to:	Do as follows:
Place a call on hold.	Press R 2 # .
Place the existing call on hold and establish a new call.	Press R and dial the second phone number followed by # .
Shuttle between the two calls.	Press R 2 # (irrespective of whether the second call was acquired using Call Hold or acceptance of Call Waiting.)
Clear the held call, if no waiting call exists.	Press R 0 # .
Clear an active call and return to the held call.	Press R 1 # . Note that this is only possible if no waiting call exists.

Transferring a call

Note

The phone must have an R key to be able to use these functions.
The EXPLORER Bluetooth Handset uses a softkey in stead of the R key.

When you receive a call, you can transfer this call to another phone or headset connected to the EXPLORER 500.

To transfer the incoming call to another phone or headset, do as follows:

1. Press **R 4 * <local number> #**.

The phone or headset with the local number you dialed starts to ring.

If your phone and the recipient's phone or headset are both Bluetooth devices, your phone is now disconnected. When the call is answered, a connection is established between the initial caller and the new recipient.

2. If only one or none of the devices are Bluetooth devices, you have two options.
 - Hang up. The phone or headset you transferred the call to continues to ring. When the call is answered, a connection is established between the initial caller and the new recipient.
 - Do not hang up. When the new recipient answers, you can have a conversation before hanging up. When you hang up, the call is handed over to the initial caller.

Sending or receiving a fax message

Handling delays

When sending or receiving fax messages over satellite, both fax units must be capable of handling longer delays without timing out. Some fax machines have an Overseas mode, which enables the unit to handle the long delays.

Sending a fax message

The fax machine must be connected to the Phone/Fax interface of the EXPLORER 500. Refer to *Before connecting to the Phone/Fax interface* on page 54.

3.1 kHz Audio must be used for an analog fax machine. Refer to *Selecting the default outgoing call type* on page 52.

To send a fax from a fax machine connected to the EXPLORER 500, dial
00 <country code> <phone number> #

Example: To send a fax to Thrane & Thrane in Denmark (+45 39558888),
dial **00 45 39558888 #**

Note If the default setting in the web interface is not 3.1 kHz Audio, you can dial 2 * before the number, to force the connection to use 3.1 kHz Audio. For further information, see *Overriding the default outgoing call type* on page 52.

Receiving a fax message

An analogue fax machine connected to the EXPLORER 500 can only receive a fax with 3.1 kHz Audio. Refer to *Selecting the incoming call type* on page 53.

Make sure the fax is sent to the 3.1 kHz Audio phone number and that 3.1 kHz Audio is enabled for the Phone/Fax interface.

Using a computer

Choosing an interface for data connection

The EXPLORER 500 has three types of interface for data connection: LAN, USB and Bluetooth.

The following table shows some characteristics of each interface, to help you choose the right interface for your application.

Interface	Power Consumption	Amount of Setup	Range
LAN	High	None (or very little)	Up to 100 m of cable
USB	Low	Some setup necessary	Up to 5 m of cable
Bluetooth	Medium	Can be complicated, depending on operating system.	Wireless connection. Up to 100 m depending on the transmitter in the computer and on the transmission conditions.

Standard or Streaming data

Definition

The BGAN network supports different classes of data connection to the Internet. The main classes are Standard data and Streaming data.

- Using a **Standard data** connection, several users can share the data connection simultaneously. This type of connection is ideal for TCP/IP traffic such as e-mail, file transfer, and Internet and intranet access.
The user pays for the amount of data sent and received.
- Using a **Streaming data** connection, you get an exclusive, high-priority connection, ensuring seamless transfer of data. This type of connection is ideal for time critical applications like live video over IP.
The user pays for the duration of the connection (per minute charge).

Note For optimum performance it is important that you select the right traffic class when defining profiles for your connection.

You can set up various types of connection using the profiles and a traffic flow filter. For further information, see *Using Profiles* on page 130 and *Using a Traffic Flow Template* on page 133.

Setting up and activating a Streaming connection

By default, any data connection on the EXPLORER 500 is a **Standard data** connection.

If you want to set up a Streaming connection, select a Streaming profile when setting up your data interface. See the “Configuring...” section for your interface in Chapter 5, *Using the web interface*.

Before starting a Streaming session on the LAN interface, make sure you have set up the Streaming profile for the LAN interface.

To start or stop a Streaming session on the LAN interface, do as follows:

1. Access the web interface.
2. Select **DASHBOARD** from the left navigation pane.
3. At the bottom of the page, click the **Start** or **Stop** link of the relevant Streaming profile.

Note When running a Streaming session you are charged for the time you are connected. A started Streaming session will stay active until you stop it.

Using the LAN interface

Before connecting to the LAN interface

To connect to the LAN (Local Area Network) interface, use a shielded cable mounted with an RJ-45 connector.

The LAN interface is configured as MDI-X. This means that if you are connecting your computer directly to the EXPLORER 500, you should use a **straight** cable. If you are connecting a switch to the EXPLORER 500, use a crossed cable.

For specifications, refer to *LAN interface* on page 159.

For the LAN interface to work without any further setup, the computer must be set up to obtain an IP address and a DNS server address automatically.

To check these settings on your computer, do as follows (For Windows XP):

1. Select **Connect To > Show All Connections** from the **Start** menu.
2. Double-click **Local Area Connection**.
3. Click **Properties**
4. Select **Internet Protocol (TCP/IP)** from the list and click **Properties**.
Make sure both fields are set to obtain an address automatically.

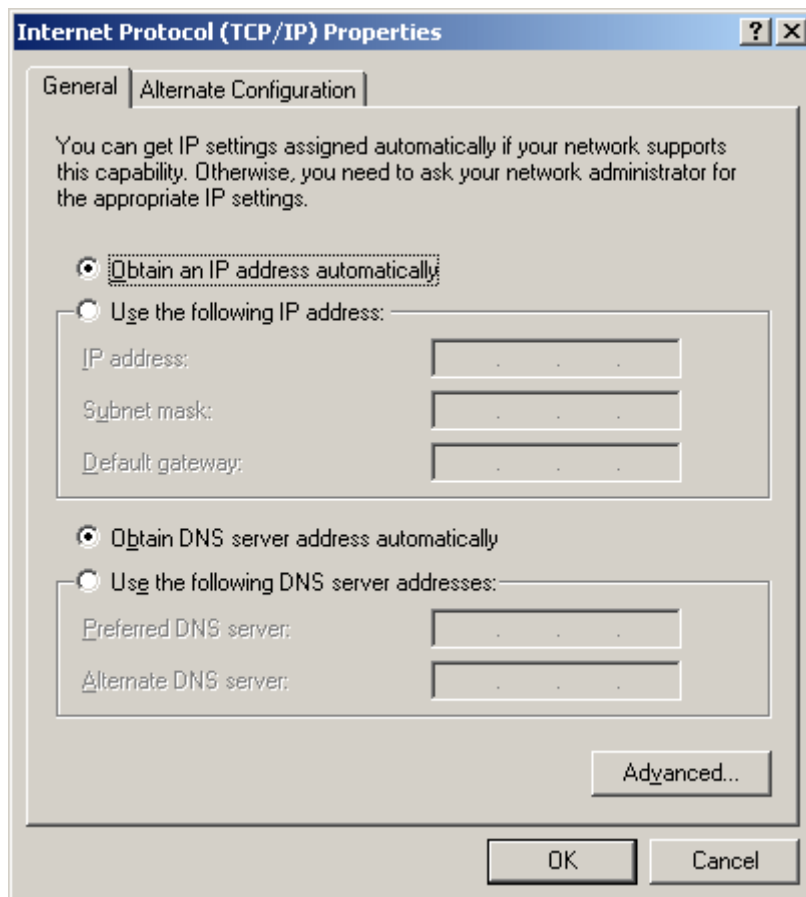

Connecting to the LAN interface

This section does not describe configuration of the LAN interface. For information on configuration, see *Configuring the LAN interface* on page 99.

To connect to the LAN interface, do as follows:

1. Connect the LAN cable to the network interface of your computer.
A suitable cable is provided with your EXPLORER 500.
2. Connect the other end of the cable to the LAN connector on the EXPLORER 500.

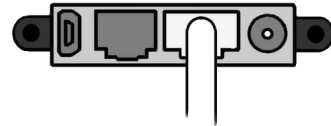

3. Power up the EXPLORER 500 and point the antenna as described in *Pointing the antenna* on page 21.
After pointing, the connection is automatically established. By default, the connection is a Standard data connection.
4. Check the connection, e.g. by starting your Internet Browser.

If connection fails, check that the interface is enabled in the EXPLORER 500. If the LAN icon is not present in the display Main screen and in the Dashboard in the web interface, the interface is disabled. See *Enabling or disabling an interface* on page 50.

If connection still fails, refer to the *Troubleshooting Guide* on page 146.

Using the USB interface

Before connecting to the USB interface

To connect to the USB (Universal Serial Bus) interface, use a USB cable mounted with a USB Mini-B connector. A suitable cable is provided with your EXPLORER 500. For specifications, refer to *USB interface* on page 160.

First time setup of USB

If it is the first time you connect your computer to the EXPLORER 500 using the USB interface, or you have exchanged the EXPLORER 500 with another EXPLORER 500, you must install a driver as follows:

1. Power up your computer.
2. Connect the USB cable to the USB port of your computer.
3. Connect the other end of the cable to the USB connector on the EXPLORER 500.
4. Power up the EXPLORER 500 as described in *Getting started* on page 11.
5. Your computer should now automatically discover that new hardware is connected.



Note | The following description is for **Windows XP**. If you are using a different operating system, the procedure may be different.

6. On **Windows XP**, the New Hardware Wizard will start automatically. Go through the wizard as follows:
 7. In the New Hardware Wizard, select **No, not this time** when you are asked if Windows can search for software.
 8. Click **Next**.
 9. Insert the Thrane & Thrane CD-ROM provided with your EXPLORER 500 into the CD-ROM drive of your computer.
 10. Select **Install the software automatically** and click **Next**.
 11. If you get a warning that the software has not passed Windows logo testing, you can safely click **Continue Anyway**.
 12. Click **Finish** when the installation is complete.
- When you finish the wizard, the Thrane & Thrane EXPLORER USB driver is installed. To verify that the installation was successful, display the list of modems on your computer (for details, refer to the documentation for your operating system).

Two ports called **Thrane & Thrane EXPLORER port 1** and **Thrane & Thrane EXPLORER port 2** should be displayed.

13. Create a dial-up connection as described in *Creating a dial-up connection* on page 71.

Connecting to the USB interface

This section does not describe configuration of the USB interface. For information on configuration, see *Configuring the USB interface* on page 97.

If you are connecting your computer to the USB interface for the first time, see *First time setup of USB* on page 67.

To connect to the USB interface, do as follows:

1. Power up your computer.
2. Connect the USB cable to the USB port of your computer.
3. Connect the other end of the cable to the USB connector on the EXPLORER 500.
4. Power up the EXPLORER 500 and point the antenna as described in *Getting started* on page 11.
5. **To enable communication** on the USB interface, open your dial-up connection as described in the following steps.



Note The following description is for **Windows XP**. If you are using a different operating system, the procedure may be different.

6. In Windows XP, select **Connect To** from the **Start** menu.
7. Select the dial-up connection created for this USB connection.
8. Click **Dial** and wait for the connection to be established. Then start your Internet browser or mail program.

If connection fails, refer to the *Troubleshooting Guide* on page 147.

Using 64 kbps UDI (ISDN) through the USB interface

You can communicate using ISDN through the USB interface of the EXPLORER 500, provided that your Internet Service Provider (ISP) supports Unrestricted Digital Information (UDI) and that it is included in your subscription.

The necessary setup is very limited, so you can very quickly establish a live connection. Note however, that you are charged for the time you are connected (per minute rate).

Do as follows:

1. Make sure 64 kbps UDI is included in your subscription.
2. From your Airtime Provider, acquire the ISP phone number, User name and Password to access the 64 kbps UDI service.
3. If you have not yet installed the Thrane & Thrane EXPLORER USB driver from the Thrane & Thrane CD, install it as described in *First time setup of USB* on page 67.
4. Connect and create a dial-up connection as described in *Creating a dial-up connection* on page 71, **with the following exceptions:**
 - When you are asked for a phone number, type in the ISP phone number.
 - When you are asked for User name and password, type in the User name and Password provided by your ISP.
5. To enable communication, simply open your 64 kbps UDI dial-up connection and click **Dial**. You now have a 64 kbps UDI connection to the Internet.

Using a computer with Bluetooth

Before connecting a computer to the Bluetooth interface

The EXPLORER 500 supports various Bluetooth profiles. Remember to activate/install the profile(s) you are going to use on your computer.

For a list of supported Bluetooth profiles, see *Bluetooth interface* on page 161.

The computer should be placed within a maximum distance of 100 m from the EXPLORER 500. Note that this is the maximum distance in open air; the actual maximum distance may be shorter, depending on the environment. In an office environment, you should be able to establish a connection across the adjoining 2-3 rooms.

Note | The procedure may vary depending on the Bluetooth interface in your computer. Consult your Bluetooth manual for details.

If the two devices have not been connected before, you need to pair the devices. For further information, see the section *Bluetooth pairing* on page 51.

Connecting a computer to the Bluetooth interface

This section does not describe configuration of the Bluetooth interface. For information on configuration, see *Configuring the Bluetooth interface* on page 104.

If the devices are already paired, do as follows to connect:

1. Place the computer close to the EXPLORER 500.
2. Power up the EXPLORER 500 and point the antenna.
3. Power up your computer.
4. Turn on Bluetooth on your computer.

If the devices are paired, the Bluetooth connection should now be established.

Note that if your Bluetooth connection is defined as a dial-up connection, you have to open the dial-up connection before you can access the Internet or the web interface. See *Connecting to the USB interface* on page 68.

Note | Max. 7 devices, including voice and data devices, can be connected simultaneously.

If connection fails, check that the interface is enabled in the EXPLORER 500.

If the Bluetooth icon is not present in the display Main screen and in the Dashboard in the web interface, the interface is disabled. See *Enabling or disabling an interface* on page 50. If the interface is enabled but connection fails, refer to the *Troubleshooting Guide* on page 148.

Creating a dial-up connection

Do as follows:

Note

The following description is for **Windows XP**. If you are using a different operating system, the procedure may be different.

1. Start up your computer and the EXPLORER 500.
2. Connect the USB cable between your computer and the USB connector on your EXPLORER 500, or place your paired Bluetooth computer close to the EXPLORER 500. For information on Bluetooth, see *Using a computer with Bluetooth* on page 70.
3. On your computer, select **Connect To** from the **Start** menu.
4. Select **Show All Connections**.
5. Open the **New Connection Wizard** and click **Next**.
6. Select **Connect to the Internet** and click **Next**.
7. Select **Set up my connection manually** and click **Next**.
8. Select **Connect using a dial-up modem** and click **Next**.
If other modems are installed, the Wizard now shows a list of all installed modems.
For USB, select Thrane & Thrane EXPLORER port 1 or 2 from the list.
For Bluetooth, select your Bluetooth driver from the list.
9. In the **ISP Name** field, type a name for your connection and click **Next**.

10. When you are asked for a phone number, type:
***98#** if you want a Standard data connection to the Internet and/or the web interface, or ***99#** if you are going to connect **only** to the web interface in the EXPLORER 500.

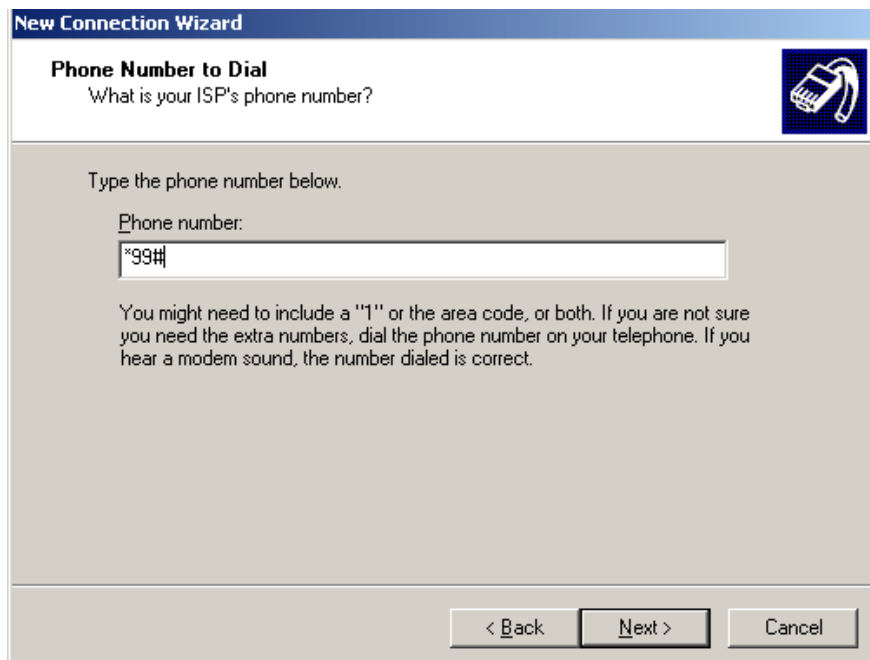

To dial up using a specific profile, type ***98*<CID>#**.

To find the <CID> number, access the web interface, select **SETTINGS > USB** (or Bluetooth) and locate the profile CIDs section at the bottom of the window.

For further information, see *Configuring the USB interface* on page 97 or *Configuring the Bluetooth interface* on page 104.

11. Click **Next**.
12. If you are using UDI, enter the User name and Password and click **Next**.
 If you are not using UDI, simply click **Next** without entering User name and Password.
 See *Using 64 kbps UDI (ISDN) through the USB interface* on page 69.
13. Click **Finish**.

When you connect to the USB interface, or to the Bluetooth interface using dial-up, you must open this dial-up connection to access the Internet or the web interface.

To open the dial-up connection (in Windows XP), select **Connect To** from the **Start** menu, select your dial-up connection and click **Dial**. When the connection is established, you can access the Internet as usual.

Note You may need to enter User name and Password to access the Internet. If necessary, enter the User name and Password supplied by your Internet Provider.

Additional interfaces

Using the EXPLORER[®] Bluetooth Handset charger

Before connecting to the EXPLORER[®] Bluetooth Handset charger interface

If you are using an EXPLORER Bluetooth Handset, you can recharge the handset using the DC charger interface of the EXPLORER 500.

Use the charger cable supplied with the EXPLORER Bluetooth Handset.

For specifications on the charger interface, see *EXPLORER[®] Bluetooth Handset charger interface* on page 163.

Connecting to the EXPLORER[®] Bluetooth Handset charger interface

Do as follows:

1. Connect the EXPLORER 500 to power, either using the AC/DC adapter connected to a 100-240 V AC electrical outlet, or the Car charger cable connected to the cigarette lighter socket/12 V DC in a car.

Note

The Bluetooth handset charger cannot recharge the Bluetooth handset from the EXPLORER 500 battery. The EXPLORER 500 must be connected to external power.

2. Connect the Bluetooth charger cable to the charging connector on the EXPLORER 500.

The charging connector is located at the back of the EXPLORER 500, and is marked **DC OUT**. Make sure the connector is oriented correctly in relation to the coding of the plastic insert.



3. Connect the other end of the cable to your EXPLORER Bluetooth Handset. If the EXPLORER 500 is connected to power, the battery of the Bluetooth Handset is now recharged.

What's next?

This chapter has described the basics of how to set up and use each interface.

The following chapter, *Using the web interface*, describes how to use the built-in web interface for setting up and using the EXPLORER 500.

Using the web interface

In this chapter

This chapter describes how to use the web interface to operate, set up and configure the EXPLORER 500.

Initial configuration of interfaces is described in the chapter *Using the interfaces* on page 48.

Introduction

The web interface

What is the web interface?

The web interface is a built-in web server in the EXPLORER 500, used for operating, setting up and configuring the EXPLORER 500.

You can access the web interface from a standard Internet browser.

Internet Explorer 6.0, Mozilla Firefox 1.0 and Apple Safari 2.0 have been tested successfully with the web interface.

You may be able to use other browser versions as well.

Connecting

Connect your computer to the EXPLORER 500.

Make sure your computer is set up for the interface you are planning to use for connecting to the EXPLORER 500. You can use LAN, USB, or Bluetooth. See *Using the interfaces* on page 48 for details.

To access the web interface, an Internet browser must be installed on the computer.

Important

If you are going to use USB or Bluetooth with Dial-up Networking to access **only** the web interface and **not** the Internet, you must use a dial-up connection with the phone number set to ***99#**. For further information, see *Creating a dial-up connection* on page 71.

Browser settings

If you are connecting your computer using the LAN interface, the **Proxy server** settings in your browser must be disabled before accessing the web interface.

Most browsers support disabling of the Proxy server settings for one specific IP address, so you can disable Proxy server settings for the web interface only, if you wish. Consult your browser help for information.

To disable the use of a Proxy server completely, do as follows:

Note The following description is for **Microsoft Internet Explorer**. If you are using a different browser, the procedure may be different.

1. In Microsoft Internet Explorer, select **Tools > Internet Options > Connections > LAN Settings**.

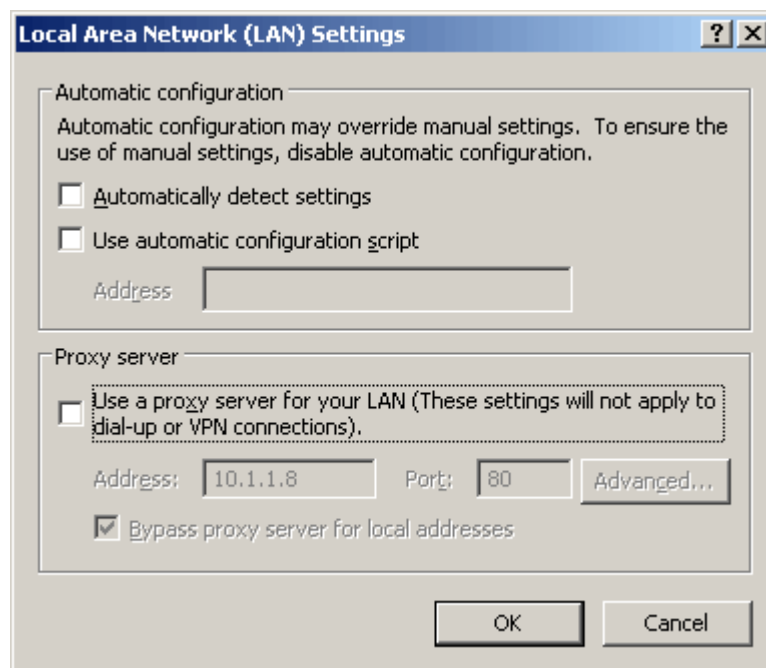

2. Uncheck the box labeled **Use a proxy server for your LAN**.

3. Click **OK**.

When the proxy server settings are disabled, close your browser.

You may need to change this setting back on return to your Internet connection.

Accessing and navigating the web interface

Accessing the web interface

To access the web interface from a connected computer, do as follows:

1. Connect your computer to the EXPLORER 500.
For further information, see *Using a computer* on page 63.
2. Start up the EXPLORER 500.
For further information, see *Getting started* on page 11.
3. Open your browser and enter the IP address of the EXPLORER 500.
The standard IP address is **192.168.0.1**.
If your EXPLORER 500 uses a different IP address, you can look it up by entering the display menu system of the EXPLORER 500 and selecting **PROPERTIES > IP ADDRESS**.

Overview of the web interface



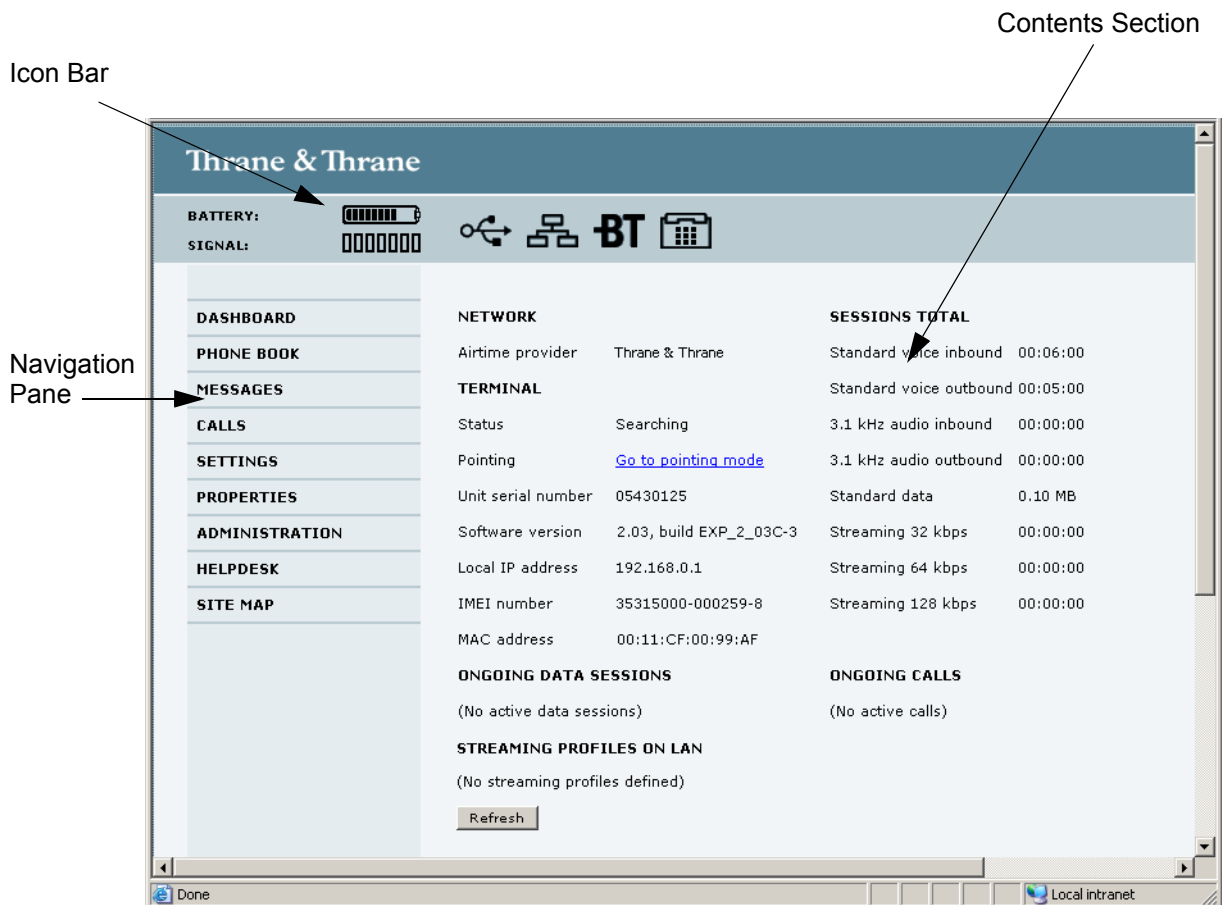



The web interface consists of the following sections.



- The **navigation pane** holds the main menu. Clicking an item in the menu opens a submenu in the navigation pane or a new page in the contents section.
- The **status field** shows battery status and signal strength.
- The **icon bar** shows an icon for each interface that is enabled. It also shows icons for new SMS messages and for active alarms, when relevant. For explanations of the icons, see the next section, *Icons in the icon bar*.
- The **contents section** shows the page selected in the navigation pane. This section is used for viewing or changing settings, or for performing actions.

Icons in the icon bar

The following icons may appear in the icon bar in the web interface:

Icon	Explanation
	Phone/Fax interface is on.
	Bluetooth interface is on.
	LAN interface is on.
	USB interface is on.
	A new SMS message, or information of Voice mail, has arrived. Click the icon to see new messages or information of Voice mail. For further information, see <i>Receiving a message</i> on page 88.
	An alarm is pending. Click the icon to see a list of active alarms. For explanations of the alarm messages, see <i>List of alarms</i> on page 150. Note that the alarm icon will remain in the icon bar as long as the cause of the alarm is still present.

Navigating the web interface

- **To expand a menu**, click the menu in the navigation pane.
- **To access status and settings**, click the relevant subject in the navigation pane, or an icon in the icon bar. The status or settings are displayed in the contents section.
- **To see the site map**, click **SITE MAP** in the navigation pane. Click on items in the site map to go directly to the relevant location.
- **To return to the Dashboard** from anywhere in the system, click **Dashboard** from the navigation pane.

Entering the SIM PIN in the web interface

If a computer is connected when you start up the EXPLORER 500, and the web interface is accessed, you can enter the SIM PIN from the web interface.

Until you enter the PIN, you can only access the Dashboard and the PROPERTIES window and upload software. Access to all other parts of the web interface requires a PIN.

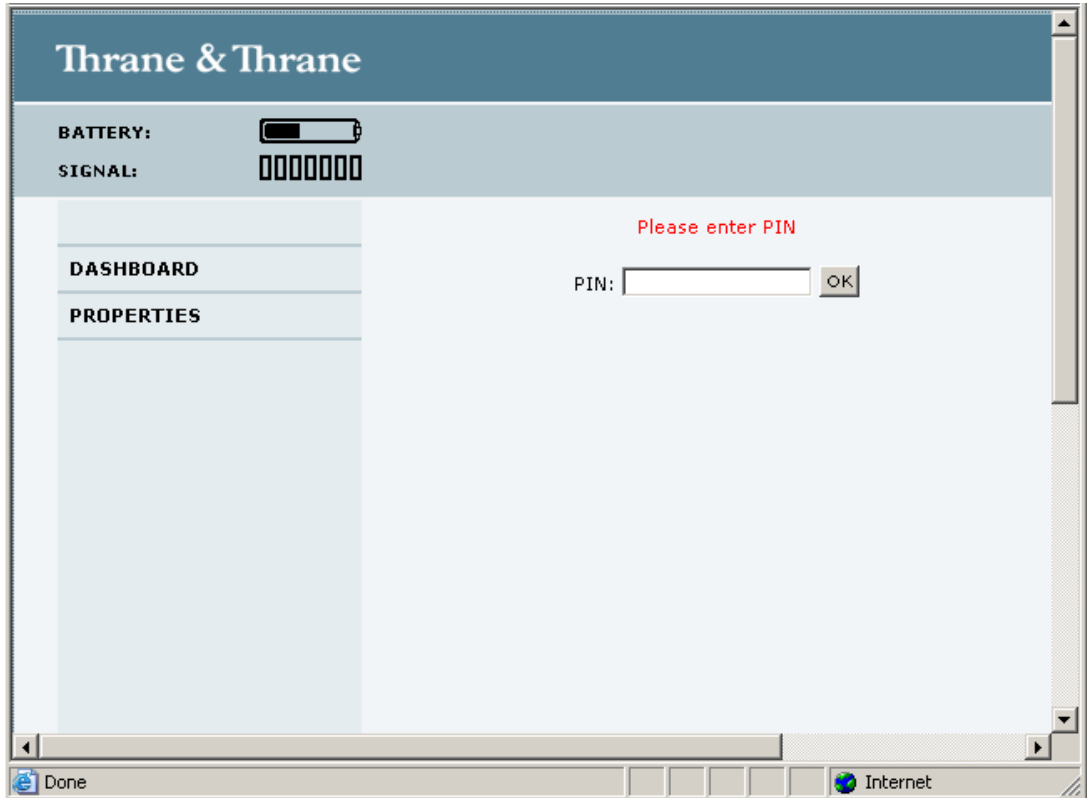

Type in the PIN and press **OK**.

When the PIN is accepted, the web interface opens the Dashboard and is ready for use.

If you enter a wrong PIN 3 times you are asked for a PUK (PIN Unblocking Key). For further information, see *Wrong PIN* on page 21.

If the PIN has already been accepted in the EXPLORER 500, or the PIN is disabled e.g. from the BGAN LaunchPad, the web interface goes directly to the Dashboard at start-up.

The Dashboard

Overview

The Dashboard is used for control and inspection of ongoing communication and for viewing properties of the EXPLORER 500.

The **NETWORK** section shows the name of the Airtime Provider, if this information is available on the SIM card.

NETWORK	TERMINAL	SESSIONS TOTAL
Airtime provider: Thrane & Thrane	Status: Searching	Standard voice inbound: 00:06:00
Pointing: Go to pointing mode	Unit serial number: 05430125	Standard voice outbound: 00:05:00
Software version: 2.03, build EXP_2_03C-3	Local IP address: 192.168.0.1	3.1 kHz audio inbound: 00:00:00
IMEI number: 35315000-000259-8	MAC address: 00:11:CF:00:99:AF	3.1 kHz audio outbound: 00:00:00
MAC address: 00:11:CF:00:99:AF	ONGOING DATA SESSIONS: (No active data sessions)	Standard data: 0.10 MB
	STREAMING PROFILES ON LAN: (No streaming profiles defined)	Streaming 32 kbps: 00:00:00
		Streaming 64 kbps: 00:00:00
		Streaming 128 kbps: 00:00:00
		ONGOING CALLS: (No active calls)

Terminal properties

The **TERMINAL** section of the Dashboard shows the following:

- **Status.** The status of the EXPLORER 500. This field corresponds largely, but not completely, to the status information in the display. Examples of status information are: Ready, Registering and Data.
- **Pointing.** If you want to point the antenna, click the link **Go to pointing mode**. For further information, see *Pointing using web interface* on page 81.
- **Unit serial number.** The serial number of the total unit.
- **Software version.** The version of the software embedded in the EXPLORER 500.
- **Local IP address.** The local IP address of the EXPLORER 500.
- **IMEI number.** The IMEI number (International Mobile Equipment Identity) of the EXPLORER 500. This is a unique number that identifies your EXPLORER 500.
- **MAC address** of the EXPLORER 500.

Managing calls and data sessions

Start/stop a Streaming session on the LAN interface

Note Before starting a Streaming session, make sure you have set up a Streaming Profile and activated it in the SETTINGS > LAN window.

To start or stop a Streaming session, click the relevant link under **STREAMING PROFILES ON LAN**. For information on setup of the LAN interface, see *Configuring the LAN interface* on page 99. For information on how to set up a Profile, see *Using Profiles* on page 130.

Start/stop Standard data on the LAN interface

By default, Standard data is always activated on the EXPLORER 500. If you want Standard data to be activated only when you have specifically enabled it, you can disable automatic activation using the SETTINGS > LAN page.

When automatic activation is disabled in the LAN page, you can manually activate/deactivate Standard data from the Dashboard by clicking **Start Standard** or **Stop Standard** under **PROFILES ON LAN** at the bottom of the page.

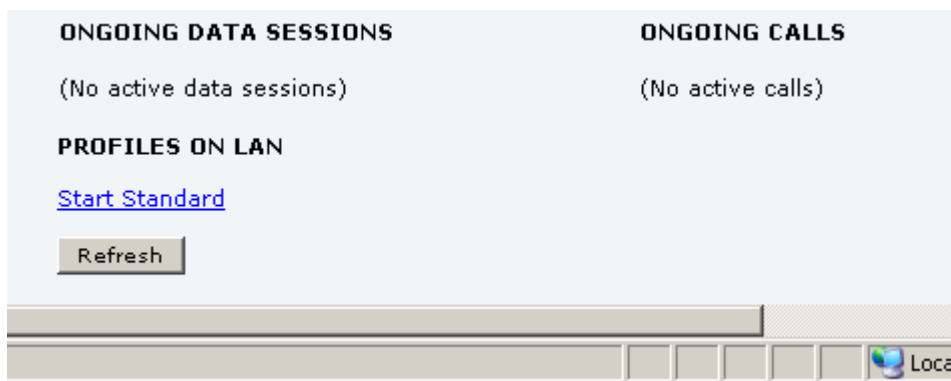

Viewing information on calls and data sessions

The following sections in the Dashboard show information on calls and data sessions.

- **ONGOING CALLS** is a list of calls that are currently active. The list shows the Voice quality and the time connected for each call.
- **ONGOING DATA SESSIONS** is a list of data Profiles that are currently active, including the IP address that is assigned to each PDP context.
- **SESSIONS TOTAL** lists the totals for each connection. The list shows the time connected for voice and Streaming data, and MB transferred for Standard data.

Pointing using web interface

Instead of using the display for observing the signal strength you can view and accept the signal strength in the web interface.

Do as follows:

1. From the **TERMINAL** section of the **Dashboard**, click the link **Go to pointing mode**. The Pointing window opens, and the EXPLORER 500 enters pointing mode.

Note

At this point the EXPLORER 500 may make a sound. This sound is used for pointing the antenna. The frequency of the sound increases with the signal strength.

To toggle the pointing sound on/off, press ▲ or ▼ on the keypad of the EXPLORER 500.

2. Point the antenna as described in *Pointing the antenna* on page 21, while observing the signal strength in the web interface.
3. When you have obtained the highest signal strength you can get, click **Accept**.



WARNING! After accepting the signal strength, keep the minimum safety distance of 0.6 m to the antenna. The antenna may radiate microwave power as soon as the signal strength is accepted.

The web interface now returns to the Dashboard, and the EXPLORER 500 tries to establish a connection and register on the BGAN network.

Using the phone book

General usage

Overview

In the phone book you can:

- Look up phone numbers.
- Look up short dial numbers for easy dialing from an analog or Bluetooth handset.
- Modify or delete existing names and phone numbers, or enter new names and phone numbers.

Accessing the phone book

To access the phone book, select **PHONE BOOK** from the left navigation pane.

The screenshot shows the Thrane & Thrane web interface. At the top, there is a header with the company name and a status bar containing battery and signal indicators, along with Bluetooth and other device icons. A left-hand navigation pane lists various menu items, with 'PHONE BOOK' currently selected and highlighted. The main content area displays a table of phone book entries.

Entry	Name	Number	Actions
1	Mr. Jones	+511111234	Edit/Delete
2	Alistair	+123456789	Edit/Delete
3	<input type="text"/>	<input type="text"/>	<input type="button" value="Save entry"/>
4			New
5			New
6			New
7			New
8			New
9			New
10			New
11			New
12			New
13			New
14			New
15			New
16			New
17			New
18			New
19			New
20			New

At the bottom of the table area, there is a link: [Delete all entries in phone book](#). Below the table, a row of numbers 1 through 10 is visible, likely serving as a page indicator or search filter.

The phone book shows all entries with entry number, name and phone number. Empty place holders are also included.

To sort the phone book, click the title of the column you wish to sort by. For example, to sort by the names in the phone book alphabetically, click on **Name** in the top row of the phone book.

The phone book is divided into subpages. To select the subpages you want, click the relevant link at the bottom of the page.

Short dial

The entry number in the phone book is the Short dial number. When making a call from the EXPLORER 500 you can use this number instead of dialing the entire phone number.

Simply dial **0 <short dial>** followed by **#** or off-hook key.

Example: To call the third entry in the phone book from an analog phone, take the phone off hook and dial **03 #**.

Editing phone book entries

Adding a new entry

To add a new entry, do as follows:

1. In the phone book, locate the empty entry number where you want to add the new phone number and click **New**.
2. Type in the name and phone number of the new entry and click **Save entry**.
The new name and number are now listed at the specified entry number in the phone book.

Modifying an entry in the phone book

To modify an entry, do as follows:

1. In the phone book, click **Edit** next to the entry you want to modify.
2. Modify the name or number as wanted and click **Save entry**.
The name and/or number in the selected entry is now replaced with the new information.

Deleting an entry in the phone book

To delete an entry, click **Delete** next to the entry you want to delete.

Deleting all entries in the phone book

To delete all the entries in the phone book, click **Delete all entries in phone book** at the bottom of the **PHONE BOOK** window.

Call log

Information on total usage

To enter the CALLS window select **CALLS** from the left navigation pane. The CALLS window contains information on usage for circuit switched connections. The listed information includes:

- Time connected using Standard Voice and
- time connected using 3.1 kHz Audio.

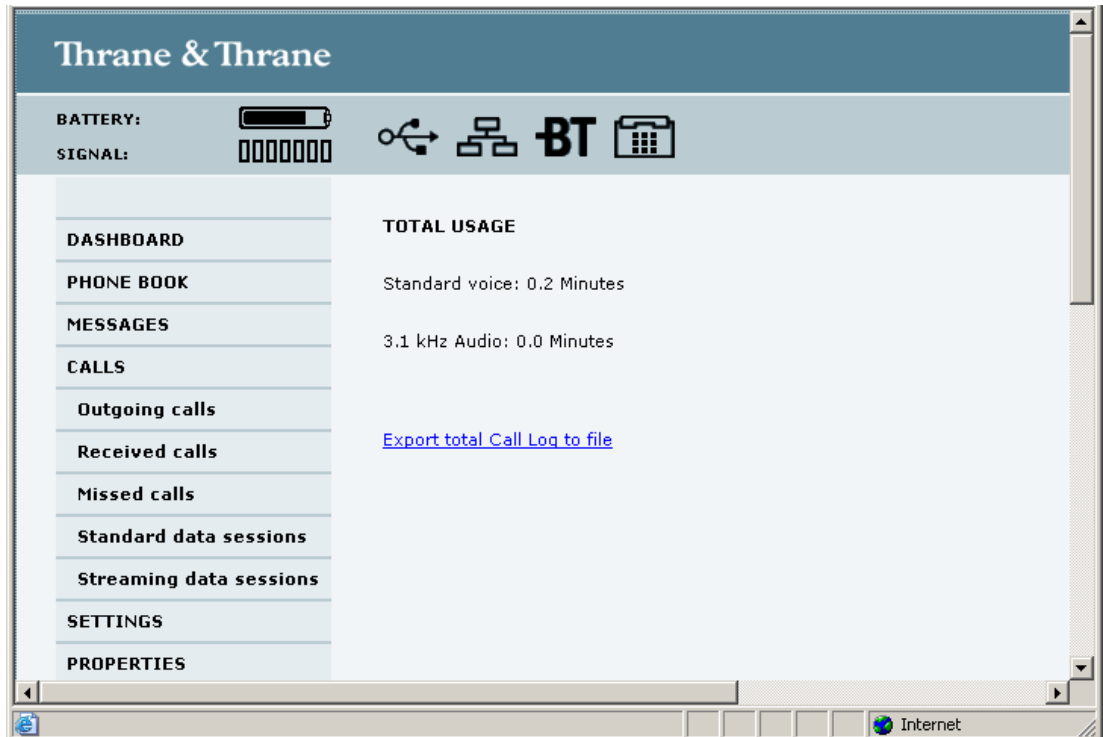

Exporting the call log

The EXPLORER 500 logs all calls and data sessions. For information on how to view the lists of calls and data sessions, see the next section.

To export the entire call log to a file, do as follows:

1. In the **CALLS** window, click the link **Export total Call Log to file**.
2. Browse to the location where you want to save the log.
3. Click **OK**.

Viewing the lists of calls

To see information on outgoing, received or missed calls or data sessions, select one of the following lists from the left navigation pane in the **CALLS** window:

- **Outgoing calls** shows the start time, receiving end phone number, duration, type (Standard or 3.1 kHz Audio) and estimated charge of each outgoing call.
- **Received calls** shows the start time, calling phone number, duration and type (Standard or 3.1 kHz Audio) of each incoming call.
- **Missed calls** shows the start time, calling phone number and type (Standard or 3.1 kHz Audio) of each incoming call that was not received.
- **Standard data sessions** shows the start time, bytes in, bytes out and estimated charge of each Standard data session.
- **Streaming data sessions** shows the start time, duration, type (Streaming 32, 64 128 kbps) and estimated charge of each Streaming data session.

Date and time is UTC time, received from the satellite.

Note

The estimated charge is based on your entries under ADMINISTRATION > Call charges. Thrane & Thrane does not take responsibility for the correctness of this estimated charge.

You can sort each of the lists by clicking the title of the column you wish to sort by.

If a list covers more than one page, you can click the relevant link at the bottom of the page, to go to another page.

When there are more than 100 calls in the total list, the oldest calls are automatically removed to make room for new calls.

Handling messages

Sending an SMS message from the EXPLORER® 500

Important

If the EXPLORER 500 is not online when you attempt to send a message, the message is moved to the Outbox instead of the Sent folder. Messages in the Outbox are **not** automatically sent when the EXPLORER 500 goes online. For further information on the Outbox, see the next section, *Options for messages in the Outbox*.

To make sure a message has been sent, check that it has been moved to the Sent folder.

To send an SMS message **from** the EXPLORER 500, do as follows:

1. Click **MESSAGES** from the left navigation pane. This window contains new incoming messages.
2. In the left navigation pane, click **Write message**.

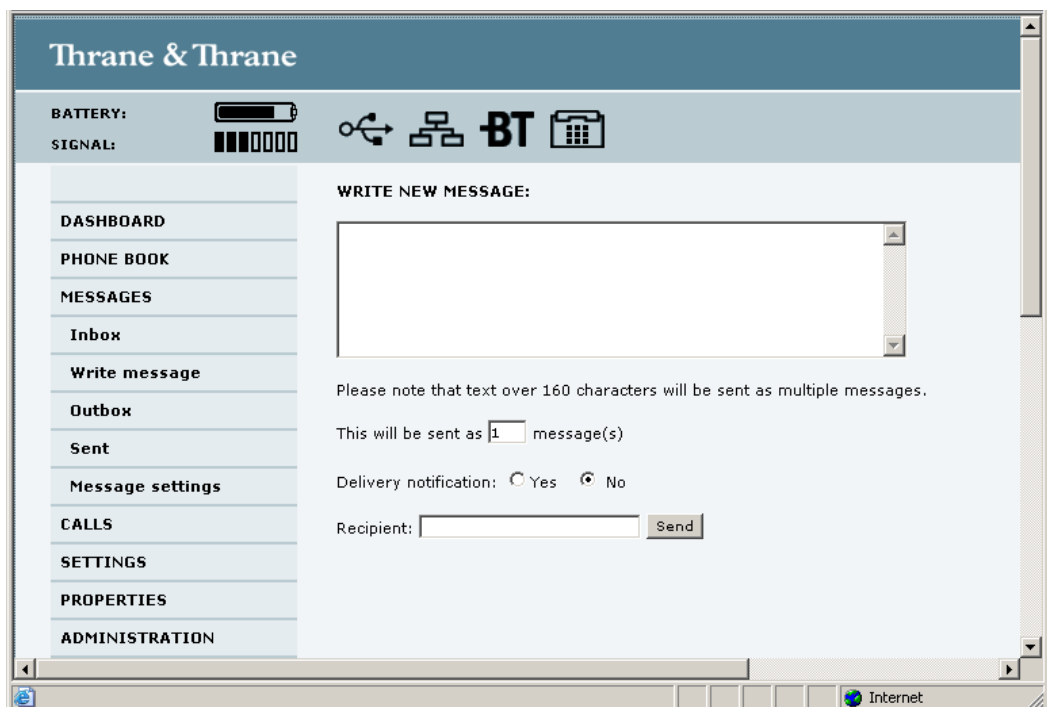

3. Type in the message in the **Write new message** field. If the message text is too long for one SMS, the message is sent as two or more SMS messages. The field below the message field shows the number of SMS messages used to send the message.
4. Type in the phone number in the **Recipient** field. Remember **00** and **country code** (e.g. **00 45** to call Denmark or **00 1** to call USA).

5. Select whether or not you want **Delivery notification** for this SMS message.
If you click Yes, the Status column in the Sent folder will show the status of your message when it has been sent.
You can set up delivery notification generally for all SMS messages. This setting is used by default when you send a message. For further information, see *Configuring message settings* on page 90.
6. Click **Send**.
If the EXPLORER 500 is online, the message is now sent and moved to the Sent folder.

Options for messages in the Outbox

Messages in the Outbox are messages that have not been sent, e.g. because the EXPLORER 500 was not online when you attempted to send the messages.

To access the Outbox, click **MESSAGES > Outbox** from the navigation pane.

You have the following options for messages in the Outbox:

- When the EXPLORER 500 is online, click **Resend** next to the message you want to send. When the Write message window opens, click **Send**.
The EXPLORER 500 now attempts to send the message again. To make sure the message has been sent, look in the Sent folder.

Note

The original message remains in the Outbox. When you have succeeded in sending the message you may want to delete it from the Outbox.

- Click **Delete** next to a message to delete it.
- Click **Delete all messages in Outbox** to delete all the messages.

Options for messages in the Sent folder

The Sent folder contains SMS messages that have been sent.

To access the Sent folder, select **MESSAGES > Sent** from the navigation pane.

The Status column shows the status of each message, if you have selected Delivery notification when sending the message.

From the Sent folder you have the following options:

- Click **Resend** next to a message you want to send again.
When the Write message window opens, click **Send**.
The EXPLORER 500 now attempts to send the message again. To make sure the message has been sent, look in the Sent folder. There should now be two copies of the sent message.
- Click **Forward** next to a message you want to forward.
When the Write message window opens, type in the phone number of the new recipient and click **Send**.
The EXPLORER 500 now attempts to send the message to the new recipient. To make sure the message has been sent, look in the Sent folder.
- Click **Delete** next to a message to delete it.
- Click **Delete all sent messages** to delete all the messages.

Sending an SMS message to the EXPLORER® 500

You can send an SMS message to the EXPLORER 500 e.g. from a mobile phone, using one of the mobile numbers for voice. Dial

+870 <Mobile number>

To see the voice numbers of your EXPLORER 500, refer to the information included with your airtime subscription.

Note

There are two Voice numbers, one for 3.1 kHz Audio and one for Standard Voice.

Receiving a message

If a message has arrived, the icon bar at the top of the web interface shows an unopened envelope. Click the envelope to see the new message(s).

Otherwise, to see new messages, click **MESSAGES** from the left navigation pane.

The window shows new incoming messages.

Note

The EXPLORER 500 does not accept more than 100 incoming messages (including read and unread messages). If you have received 100 messages, you have to delete some of them in order to free space for new messages. Otherwise, the new messages are rejected.

If the message is not an SMS message but information of voice mail, call your voice mail service number to hear the voice mail.

To find your voice mail service number, select **MESSAGES > Message settings** from the left navigation pane and locate the **Voice mail service number**.

Note that the voice mail number is only shown if it is available on the SIM card. Otherwise, refer to the information included with your Airtime subscription.

Options for new SMS messages

To see new messages, click **MESSAGES** from the left navigation pane.

Besides viewing the new messages, you have a number of options for what to do with each message:

- Click **Read** to move it to your Inbox containing read messages.
- Click **Reply** to reply to a message.
Then type in your reply and click **Send**.
For information on how to include the original message in your reply, see *Setting up the default message options* on page 90.
- Click **Forward** to forward a message to someone.
Then type in the phone number in the **Recipient** field and click **Send**.
- If you want to move all the new messages, click **Move all new messages to Inbox**.

Note | New messages cannot be deleted until they have been moved to the Inbox.

Options for SMS messages in the Inbox

The messages in the Inbox are the incoming messages that have been read and moved from the list of new messages (refer to the previous section).

From the Inbox, you have the following options:

- Click **Reply** to reply to a message.
Then type in your reply and click **Send**.
For information on how to include the original message in your reply, see *Setting up the default message options* on page 90.
- Click **Forward** to forward a message to someone.
Then type in the phone number in the **Recipient** field and click **Send**.
- Click **Delete** to delete the message.
- Click **Delete all messages in Inbox** to delete all read messages in the Inbox.

Configuring message settings

Setting up the default message options

You can set up general options for your outgoing messages. These settings apply by default to all your outgoing messages. Note, however, that you can change the Delivery notification setting for an individual message. For further information, see *Sending an SMS message from the EXPLORER® 500* on page 86.

Do as follows:

1. Select **MESSAGES > Message settings** from the left navigation pane.

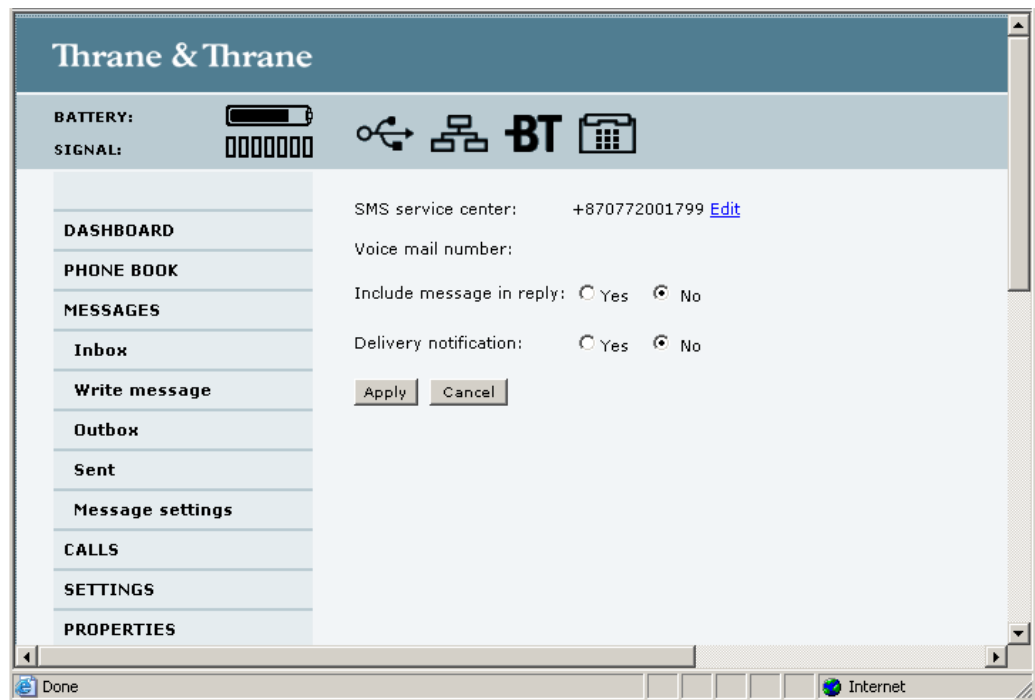

2. If you want to include the original message when you reply, select **Yes** next to **Include message in reply**.
3. Select whether or not you want **Delivery notification** for SMS messages. If you click Yes, the Status column in the Sent folder will show the status of your message when it has been sent.
4. Click **Apply**.

Viewing or changing SMS service center number

The SMS service center number identifies the SMS service center used when sending and receiving SMS messages. The SMS service center number is stored on the SIM card.

- To see the SMS service center number, select **MESSAGES > Message settings** from the left navigation pane.
- To change the number, click **Edit** next to **SMS service center**, change the number and click **Save**. Then click **Apply** to apply all changes in the window.

The SMS service center number is provided from your Airtime Provider.

Viewing the Voice mail number

The Voice mail number is the number you call to hear your incoming voice mails.

Note | The Voice mail number is only listed if it is available on the SIM card. Otherwise, refer to the information included with your Airtime subscription.

To see the Voice mail number, select **MESSAGES > Message settings** from the left navigation pane.

EXPLORER[®] 500 settings

Accessing the EXPLORER[®] 500 settings

Select **SETTINGS** from the left navigation pane. The SETTINGS window contains the local settings of the EXPLORER 500. The next sections describe these settings.

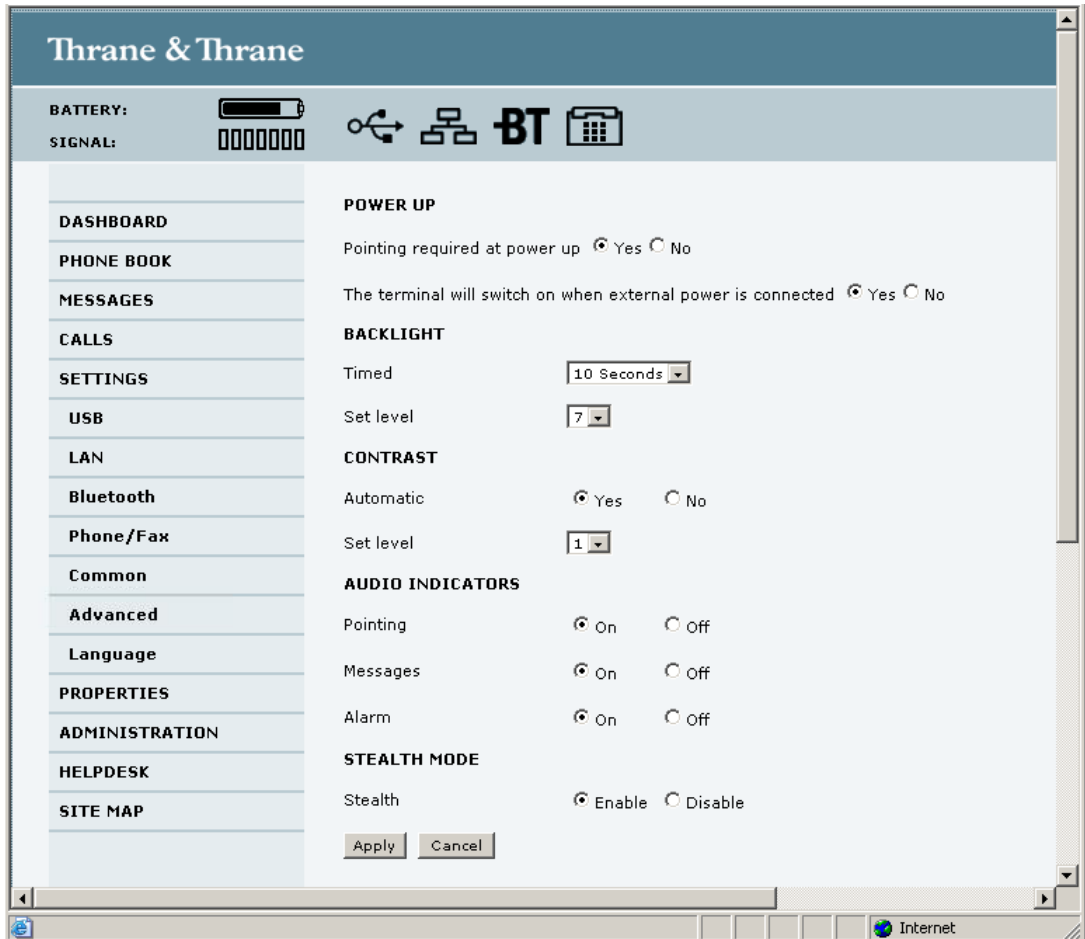

Power up behavior

Pointing at power up

If the EXPLORER 500 is placed in a fixed position it may not be necessary to go through the pointing process every time the EXPLORER 500 is powered. You can set up the EXPLORER 500 to automatically establish a connection to the BGAN network, if you know that the signal strength is sufficient.

- In the **Power up** section of the **SETTINGS** window, select whether or not pointing is required at power up.
 - To go through the pointing process every time the EXPLORER 500 is powered, select **Yes**.

- To have the EXPLORER 500 automatically register itself on the network every time the EXPLORER 500 is powered, select **No**.

2. Click **Apply**.

If you have selected that pointing is not required at power up, the start up procedure will be as follows:

1. Power up.
2. Enter the PIN. After the PIN is accepted, the EXPLORER 500 immediately tries to connect to and register on the BGAN network.

Important

Be aware that when the EXPLORER 500 registers on the BGAN network the antenna starts radiating microwave power, which means you must keep the minimum distance of 0.6 m to the front face of the antenna.

Automatic power up

1. In the **Power up** section of the **SETTINGS** window, select whether or not the EXPLORER 500 should switch on automatically when external power is applied.
 - To have the EXPLORER 500 switch on automatically when external power is applied, select **Yes**.
 - To have the EXPLORER 500 switch on only when the power button is pressed, click **No**.
2. Click **Apply**.

Setting the display backlight and contrast

To set the display backlight and contrast, do as follows:

1. In the **Backlight** section of the **SETTINGS** window, set the timing.
The **Timed** period is the period of time the light will stay on after the last key is pressed.
2. Set the level of the backlight with the **Set level** scroll bar.
3. In the **Contrast** section, click **Yes** next to **Automatic** if you want the contrast to be adjusted automatically according to the temperature.
The contrast of the display changes with the temperature. The EXPLORER 500 can automatically adjust the contrast to compensate for these variations.
4. If you want to set the contrast manually, set the contrast level with the **Set level** scroll bar.
5. Click **Apply**.

Turning audio indicators on or off

The EXPLORER 500 has audio indicators for different events or situations.

To enable or disable these audio indicators, do as follows:

1. In the **Audio indicators** section of the **SETTINGS** window, turn the audio indicators on or off using the radio buttons. Each audio indicator is explained below.
2. Click **Apply**.

The EXPLORER 500 has audio indicators for the following events:

- **Pointing.**
The Pointing sound is used during the pointing process. The frequency increases with the signal strength, to help you find the maximum signal strength when pointing the antenna. This setting is a default setting. When the EXPLORER 500 is in pointing mode, you can toggle pointing sound on/off for the current pointing process using ▲ or ▼ on the keypad of the EXPLORER 500. However, the default setting applies at the next pointing process.
- **Messages.**
The Message indicator is a sound indicating that a message has arrived.
- **Alarm.**
The Alarm indicator is a sound indicating that an alarm is issued.
An alarm is issued if the EXPLORER 500 detects an error that requires your action.

Enabling activation of stealth mode

In Stealth mode, the EXPLORER 500 operates with no sounds nor lights. However, it is still possible to operate the EXPLORER 500 and the display text is, in most cases, readable.

Important Only enable activation of Stealth mode if you are going to use it. If Stealth mode is activated by mistake, it may be difficult to operate the EXPLORER 500.

To enable the use of Stealth mode for the EXPLORER 500, do as follows:

1. Select **SETTINGS** from the left navigation pane.
2. In the **Stealth mode** section, click **Enable**.
If you click Disable, the Stealth mode function cannot be activated.
3. Click **Apply**.

Note This setting does **not** activate Stealth mode, it only enables the use of Stealth mode. To activate Stealth mode, press **C+OK** on the keypad.
To deactivate Stealth mode and return to normal function, press **C+OK** again.

Setting up the interfaces

Enabling/disabling interfaces

By default, all interfaces are enabled. However, you can disable the LAN interface, the Bluetooth interface and/or the Phone/Fax interface in order to minimize power consumption.

The icons in the Icon bar at the top of the web interface shows interfaces that are enabled. Clicking an icon brings you to the window where you can set up the interface or enable/disable it.

Note | The USB interface cannot be disabled; it is always enabled.

To enable or disable an interface from the menu, do as follows:

1. Select **SETTINGS** from the left navigation pane.
The SETTINGS menu expands.
2. Under **SETTINGS** in the left navigation pane, select the interface you want to enable or disable.
3. At the top of the window, select **Enabled** or **Disabled**.
4. Click **Apply**.

Description of data settings

Introduction

There are several data parameters that can be set up in the web interface. This section gives an overview of these parameters.

APN (Access Point Name)

The APN is used by the EXPLORER 500 user to establish the connection to the required destination network. This means that the EXPLORER 500 must know the APN in order to be able to connect to the destination network.

APNs are provided from the Airtime Provider. They may also be defined on the SIM card.

Header compression

The Header of a data packet contains control information belonging to that packet. The information in the Header can take up a considerable amount of bandwidth. In order to save bandwidth, you can use Header Compression, meaning you compress the header information, leaving some of the information out.

You can select whether or not to use Header Compression for your data transmission.

- **Header Compression enabled:** Recommended for low-noise applications.
If you select Header Compression enabled, you will be using less bandwidth on header

information, leaving more bandwidth for the actual payload.

However, if the environment is noisy, the system will have to retransmit information, and you may end up using more bandwidth than without Header Compression.

- **Header Compression disabled:** Recommended in noisy environments. If Header Compression is disabled, the system will be less sensitive to noise.

Primary and secondary Profiles

A Profile is a collection of Quality of Service (QoS) settings and other settings defining the mode in which data is transmitted on an interface. For example, a Profile is used to define whether a connection should be a Standard or Streaming connection.

You can select between a number of predefined Profiles or define your own Profiles for your data transmission.

Note If you have selected more than one Profile (one primary and one or more secondary Profiles) for an interface, you must define a Traffic Flow Template before you can establish a valid connection.

In the EXPLORER 500, you need an Administrator password to define Profiles and Traffic Flow Templates.

NAT (Network Address Translation)

NAT enables a local-area network to use one set of private IP addresses for internal traffic and an assigned or static IP address for external traffic. The built-in NAT module in the EXPLORER 500 makes all necessary address translations between the local-area traffic and the external traffic. If more than one user is connected to the LAN interface of the EXPLORER 500, it is necessary to use a switch, as the EXPLORER 500 only has one LAN connector. If more than one user is connected using a switch, you must select **Router mode** to use the NAT of the EXPLORER 500.

Configuring the USB interface

Note | The USB interface cannot be turned off; it is always on.

For an explanation of each of the data settings, see *Description of data settings* on page 95.

To configure the USB interface, do as follows:

1. Select **SETTINGS > USB**.



2. Under **TCP/IP**, select whether your computer uses a **Dynamic IP address** or a **Static IP address**. If you are using a static IP address, type in the address. To check this setting on your computer, see the TCP/IP properties of the USB connection on your computer.
3. Under IP Header compression, select **Enabled** or **Disabled**.

If you select **Enabled**, the Header information of each data packet will be compressed, leaving more bandwidth for the actual data.

For further information, see *Header compression* on page 95.

4. Select the source of the **APN**.

There are four options for setting the APN. Unless you have special requirements, it is recommended to use the SIM default, or to set the common APN to SIM default, and then select Common here. You have the following options:

- **Common.** The APN is taken from the Common settings defined under **SETTINGS > Common**. Refer to *Setting a common APN* on page 117.
- **SIM default.** The APN is taken from the SIM card.
- **Network assigned.** The APN is assigned from the network.
- **User defined.** Type in the APN. APNs are provided from the Airtime Provider.

5. If your APN uses a password, type in the user name and password provided from the Airtime Provider.

6. Select the **Primary Profile**.

Select a Profile from the scroll list. This Profile is used by the USB interface as a first choice, when possible.

Important

If you have selected a Streaming connection as your Primary Profile, the USB interface will be running a Streaming connection until you select another Profile or disconnect the interface. However, if you select one or more Secondary Profiles, you can set up your Traffic Flow Template so that it will only use the Streaming Profile for certain types of traffic.

There are 4 predefined Profiles: Standard, Streaming 32 kbps, Streaming 64 kbps and Streaming 128 kbps. Additionally, you can define your own custom Profiles.

For further information on Profiles and Traffic Flow Templates, see *Using Profiles* on page 130 and *Using a Traffic Flow Template* on page 133.

7. Select the **Secondary Profile**.

To select more than one secondary Profile, press and hold Ctrl while selecting.

Note

If you have selected both a Primary and one or more Secondary Profiles you must define a Traffic Flow Template before you can establish a valid connection.

The Context Identifiers (CIDs) for the selected primary and secondary Profiles are listed under **Profile CIDs**. You may need these CIDs when you create a dial-up connection. See *Creating a dial-up connection* on page 71.

8. Click **Apply**.

Configuring the LAN interface

Data settings

For an explanation of each of the data settings, see *Description of data settings* on page 95.



CAUTION! If you are connected using LAN while changing the settings below, your changes may affect your current connection.

To configure the LAN interface, do as follows:

1. Select **SETTINGS > LAN**.

2. Select whether the LAN interface should be **Enabled** or **Disabled**.

3. Under **NAT mode**, select whether the EXPLORER 500 should run in Router mode or in Modem mode. Router mode is recommended for most purposes.

Select **Router mode** if one or more computers are connected using the LAN interface, and the EXPLORER 500 should act as a router. When Router mode is selected, the EXPLORER 500 uses the built-in NAT module for making the necessary address translations.

Select **Modem mode** if

- only one computer is connected to the LAN interface, and the EXPLORER 500 should act as a modem, or
- more than one computer is connected to the LAN interface using an external router.

Note Do **not** connect more than one computer to the LAN interface in Modem mode, unless you have an external router.

4. Under **DHCP status**, enable or disable DHCP.
If you select Enabled, the internal DHCP server in the EXPLORER 500 is enabled.
5. Under **Local IP address** and **Netmask**, type in the IP address and netmask for your EXPLORER 500.
This is the local IP address for your EXPLORER 500 when it is in Router mode.
6. Under **TCP/IP**, select whether your computer uses a **Dynamic IP address** or a **Static IP address**.
If you are using a static address, type in the address.
This is the IP address used externally on the satellite network.
To check this setting on your computer, see the TCP/IP properties of the LAN connection.
7. Under **IP Header compression**, select **Enabled** or **Disabled**. For information on this setting, see *Header compression* on page 95.
8. Select the source of the **APN** (Access Point Name).
There are four options for setting the APN. Unless you have special requirements, it is recommended to use the SIM default, or to set the common APN to SIM default, and then select Common here. You have the following options:
 - **Common**. The APN is taken from the Common APN defined under **SETTINGS > Common**. Refer to *Setting a common APN* on page 117.
 - **SIM default**. The APN is taken from the SIM card.
 - **Network assigned**. The APN is assigned from the network.
 - **User defined**. Type in the APN. APNs are provided from the Airtime Provider.If your APN uses a password, type in the user name and password provided from the Airtime Provider.

9. Select Automatic activation **Enabled** or **Disabled**.

Note If the selected Primary Profile is a Streaming Profile, automatic activation cannot be enabled. Streaming Profiles must always be activated manually from the Dashboard.

For non-Streaming Profiles:

- select **Disabled** to be able to control activation of the Profile manually from the Dashboard.
- Select **Enabled** to activate the Profile automatically as soon as the EXPLORER 500 is online and the LAN cable is connected. Note that this connection will stay active until you change the setting or disconnect the interface.

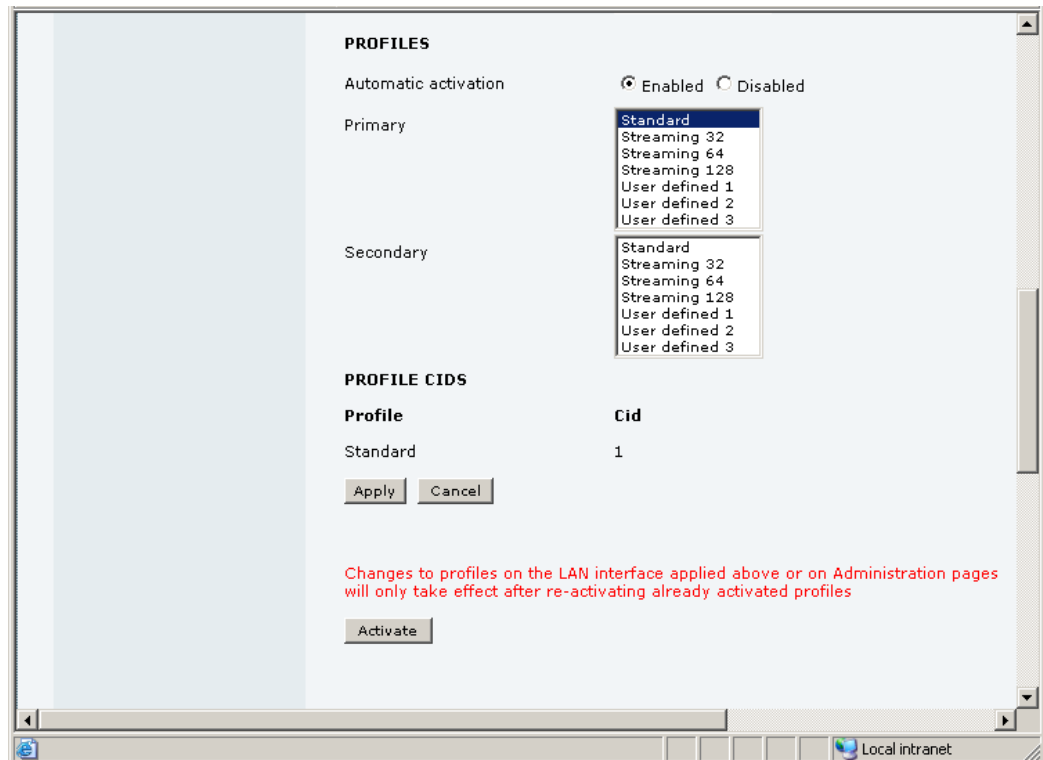

10. Select the **Primary Profile**.

Select a Profile from the Primary scroll list. This Profile is used by the LAN interface as a first choice, when possible.

There are 4 predefined Profiles: Standard, Streaming 32 kbps, Streaming 64 kbps and Streaming 128 kbps. Additionally, you can define your own custom Profiles.

Important If you have selected a Streaming connection as your Primary Profile and activated it from the Dashboard, the LAN interface will be running a Streaming connection until you stop it from the Dashboard, select another Profile or disconnect the interface. However, if you select one or more Secondary Profiles, you can set up your Traffic Flow Template so that it will only use the Streaming Profile for certain types of traffic.

For further information on Profiles and Traffic Flow Templates, see *Using Profiles* on page 130 and *Using a Traffic Flow Template* on page 133.

11. Select the **Secondary Profile**.

To select more than one secondary Profile, press and hold **Ctrl** or **Shift** while selecting.

Note If you have selected both a Primary and one or more Secondary Profiles you must define a Traffic Flow Template before you can establish a valid connection.

The Context Identifiers (CIDs) for the selected primary and secondary Profiles are listed under **Profile CIDs**.

12. Click **Apply**.
Your LAN settings are applied. Note that changes to your Profiles are not activated until you click Activate.
13. Click **Activate** if you want to activate the changes to your Profiles.

Port forwarding

Port forwarding enables you to setup a server connected to the EXPLORER 500 while the terminal is in Router mode. Without port forwarding it would not be possible to contact the server from the internet.

For information on how to set the terminal in Router mode, see *Configuring the LAN interface* on page 99.

The following example shows how to allow internet access to a mail server (smtp) connected to the terminal. The mail server in this example has the IP address 192.168.0.100.

1. Select **LAN > Port forwarding** in the left navigation pane.



2. Select **Enabled** to globally enable port forwarding.
3. Type in the port number of the **Incoming port**.
4. Type in the **Destination IP** address, which in this example is the IP address of the mail server: 192.168.0.100.
5. Type in the **Destination port** number.
6. Repeat step 3. to step 5. to set up port forwarding to additional servers.
7. In the **Active** column, select which ports should have port forwarding activated.
8. Click **Apply**.

You can now access the mail server from the Internet, using the external IP address of the EXPLORER 500.

Configuring the Bluetooth interface

For an explanation of each of the data settings, see *Description of data settings* on page 95.

The section *Preparing the EXPLORER® 500 for Bluetooth pairing* on page 107 explains the settings under INTERFACE STATUS.

To configure the Bluetooth interface, do as follows:

1. Select **SETTINGS > Bluetooth**.

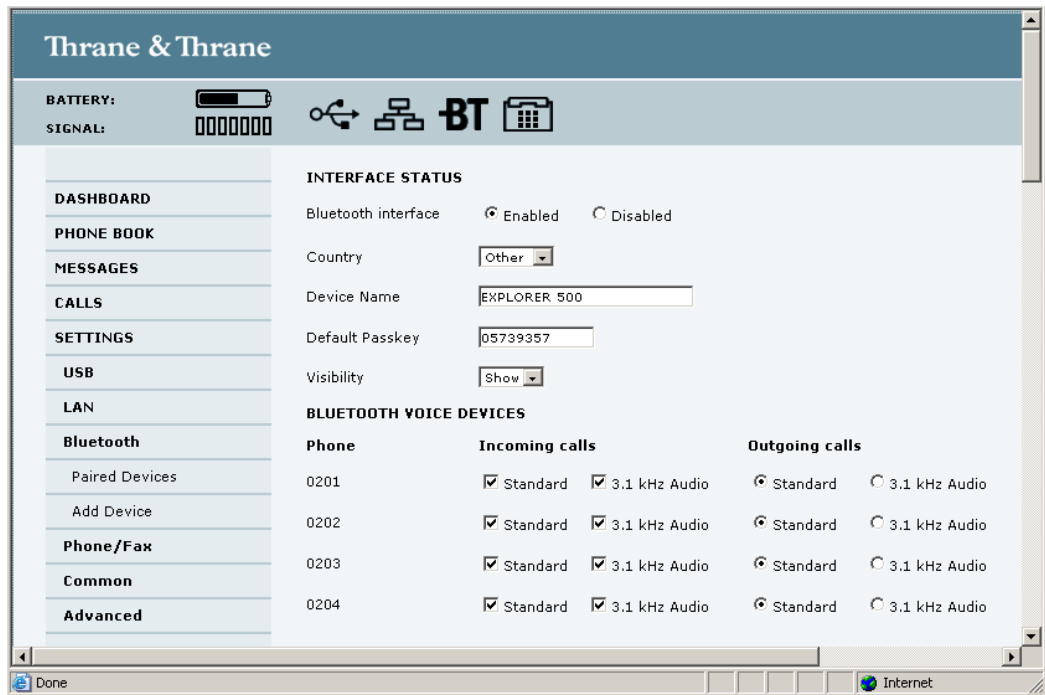

2. Under **BLUETOOTH VOICE DEVICES**, set the voice quality for incoming and outgoing calls. All paired voice devices are listed with their local phone numbers.

Voice quality is described in more detail in *Selecting the call type* on page 52.

- For **Incoming calls**, you can check Standard or 3.1 kHz Audio or both. If you check both, the voice device will react (ring) on incoming calls. If you select e.g. Standard, the voice device will only react on calls made to the Standard phone number.
- For **Outgoing calls**, you can select either Standard or 3.1 kHz Audio. The selected quality will be used by default, if possible, for any outgoing call. Note, however, that fax machines and modems must use 3.1 kHz Audio.

Note You can override the default setting for outgoing calls by dialing 1* (force a Standard call) or 2* (force a 3.1 kHz Audio call) before the number. For further information, see *Overriding the default outgoing call type* on page 52.

- For **data devices**, the settings are listed under the Bluetooth profile that is used (**Dial-up network** or **LAN**). The next steps describe the settings available under a Bluetooth profile.

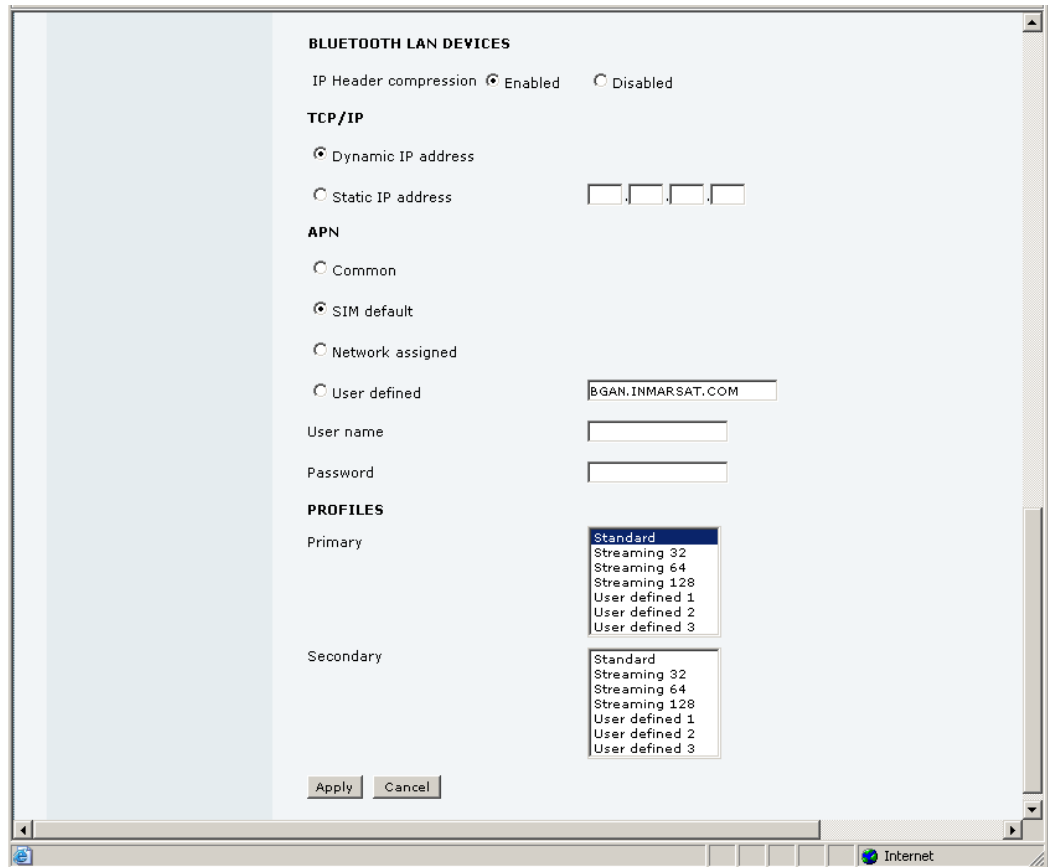

- Under **IP Header compression**, select **Enabled** or **Disabled**.
For information on Header Compression, see *Header compression* on page 95.
- Under **TCP/IP**, select whether your computer uses a **Dynamic IP address** or a **Static IP address**.
If you are using a static address, type in the address.
This is the IP address used externally on the satellite network.
To check this setting on your computer, see the TCP/IP properties of the Bluetooth connection.
- Under **APN**, select the source of the APN (Access Point Name).
There are four options for setting the APN. Unless you have special requirements, it is recommended to use the SIM default, or to set the common APN to SIM default, and then select Common here. You have the following options:
 - Common.** The APN is taken from the Common APN defined under **SETTINGS > Common**. Refer to *Setting a common APN* on page 117.
 - SIM default.** The APN is taken from the SIM card.
 - Network assigned.** The APN is assigned from the network.
 - User defined.** Type in the APN. APNs are provided from the Airtime Provider.
- If your APN uses a password, type in the user name and password provided from the Airtime Provider.

8. Select the **Primary Profile**.

Select a Profile from the scroll list. This Profile is used by the Bluetooth interface as a first choice, when possible.

There are 4 predefined Profiles: Standard, Streaming 32 kbps, Streaming 64 kbps and Streaming 128 kbps. Additionally, you can define your own custom Profiles.

Important

If you have selected a Streaming connection as your Primary Profile, the Bluetooth interface will be running a Streaming connection until you select another Profile or turn off the interface. However, you can set up your Traffic Flow Template so that it will only use this Profile for certain types of traffic.

For further information on Profiles and Traffic Flow Templates, see *Using Profiles* on page 130 and *Using a Traffic Flow Template* on page 133.

9. Select the **Secondary Profile**.

Note

If you have selected both a Primary and one or more Secondary Profiles you must define a Traffic Flow Template before you can establish a valid connection.

10. Click **Apply**.

Pairing Bluetooth devices from the web interface

What is pairing?

Bluetooth Pairing happens when two Bluetooth enabled devices agree to communicate with one another. When this happens, the two devices exchange passkeys and join a pair. The pairing process only takes place the first time the two devices are connected. Once the two devices have established a pair, they automatically accept communication when one device recognizes the other device.

Preparing the EXPLORER[®] 500 for Bluetooth pairing

To prepare the Bluetooth interface on the EXPLORER 500, do as follows:

1. Connect a computer to the EXPLORER 500, e.g. using the LAN interface.
2. Access the web interface from your connected computer.
Refer to *The web interface* on page 74.
3. In the web interface, select **SETTINGS** > **Bluetooth** and make sure that Bluetooth is **Enabled**.

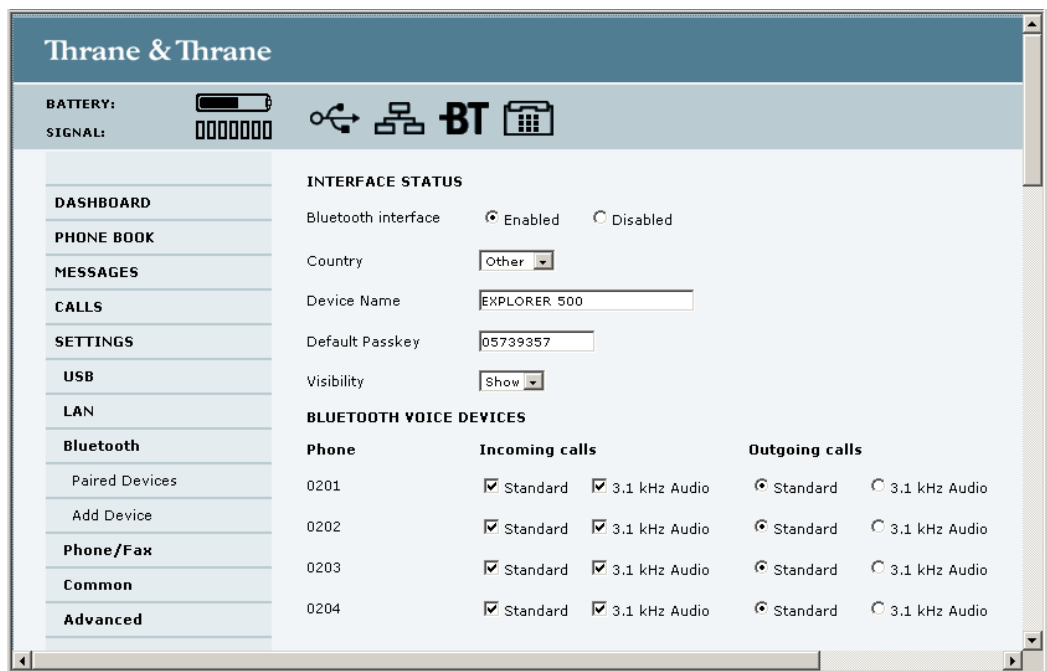

4. If your EXPLORER 500 is located in France, select **France** in the **Country** list. Otherwise, select **Other**.
5. Use the predefined **Device name** or type in a new name for your EXPLORER 500. The Device name is shown to other Bluetooth devices, if the EXPLORER 500 is configured to be shown (refer to step 7. below).
6. Use the predefined **Default passkey** or type in a new one. This passkey is used by default when pairing devices with the EXPLORER 500.

7. Next to **Visibility**, select **Show** or **Hide**.
 - If you select **Show**, the device name of the EXPLORER 500 is shown to other Bluetooth devices that are searching for devices.
 - If you select **Hide**, other Bluetooth devices will not see the EXPLORER 500.
8. Click **Apply** at the bottom of the window.

Pairing from your Bluetooth device

For information on how to pair devices from your Bluetooth device, see *Pairing devices in which you can enter a passkey* on page 51.

Pairing devices with a fixed passkey

Some Bluetooth devices, such as headsets, do not provide the possibility to enter a passkey for connecting to another device. These devices have a fixed passkey which must be entered on the other device. This section describes how to pair such devices with the EXPLORER 500.

Note

The method for pairing devices may vary depending on your Bluetooth device. Consult your Bluetooth device documentation for information.

Do as follows to pair the devices:

1. Connect a computer to the EXPLORER 500, e.g. using the LAN interface.
2. Start up the EXPLORER 500.
Refer to *Getting started* on page 11.
3. Turn on Bluetooth on your Bluetooth device and place it close to the EXPLORER 500.
4. Access the web interface from your connected computer.
For further information, see *The web interface* on page 74.
5. Select **SETTINGS > Bluetooth** and make sure that Bluetooth is **Enabled**.
6. From the left menu of the Bluetooth window, select **Add device**.
Note that you can pair maximum 7 devices. If you have already paired 7 devices, you have to unpair a device before you can pair a new one. For information on how to unpair devices, see *Unpairing devices* on page 109.
7. Click **Search**.
The EXPLORER 500 now searches for Bluetooth devices.

Note

The search procedure can take up to 2-3 minutes. The list is not updated dynamically. Click **Update** to see new found devices.

8. Click **Update**.
9. When the device you want to pair appears in the list, click **Pair** next to the device.

10. Enter the passkey of your Bluetooth device.
The default passkey for a Bluetooth headset is often 0000. Otherwise, refer to the manual for your Bluetooth device.
11. When you are prompted from the Bluetooth device, usually by a tone, press the button on the device to accept pairing.

The new device should now be paired with the EXPLORER 500 and added to the list of Paired devices. This list is accessed from the left menu of the Bluetooth window in the web interface.

As long as the Bluetooth device is in the list of Paired devices, you can always reconnect the device to the EXPLORER 500 without further setup.

Viewing paired devices

To see a list of devices that are paired with the EXPLORER 500, do as follows:

1. Access the web interface.
Refer to *The web interface* on page 74.
2. Select **SETTINGS > Bluetooth > Paired devices**.

The list shows all devices that are paired with the EXPLORER 500. You can see the name, Class of Device, status (whether or not a device is currently connected) and local phone number.

You can also see paired devices in the display. Select **PROPERTIES > BLUETOOTH DEVICES** in the display menu system to see a list of all paired devices.

Unpairing devices

To remove a device from the list of Paired devices, do as follows:

1. Access the web interface and select **SETTINGS > Bluetooth > Paired devices**.
2. In the **Paired devices** list, click **Unpair** next to the device you want to remove.

Note

If you need to unpair an EXPLORER Bluetooth Handset, make sure the handset is connected to the EXPLORER 500 while you unpair it.

If you select Unpair while the handset is not connected, it will automatically be paired again when it approaches the EXPLORER 500.

When the device is removed from the list, you have to pair it with the EXPLORER 500 again to make a connection.

Configuring the Phone/Fax settings

Do as follows:

1. Select **SETTINGS** > **Phone/Fax** from the left navigation pane.

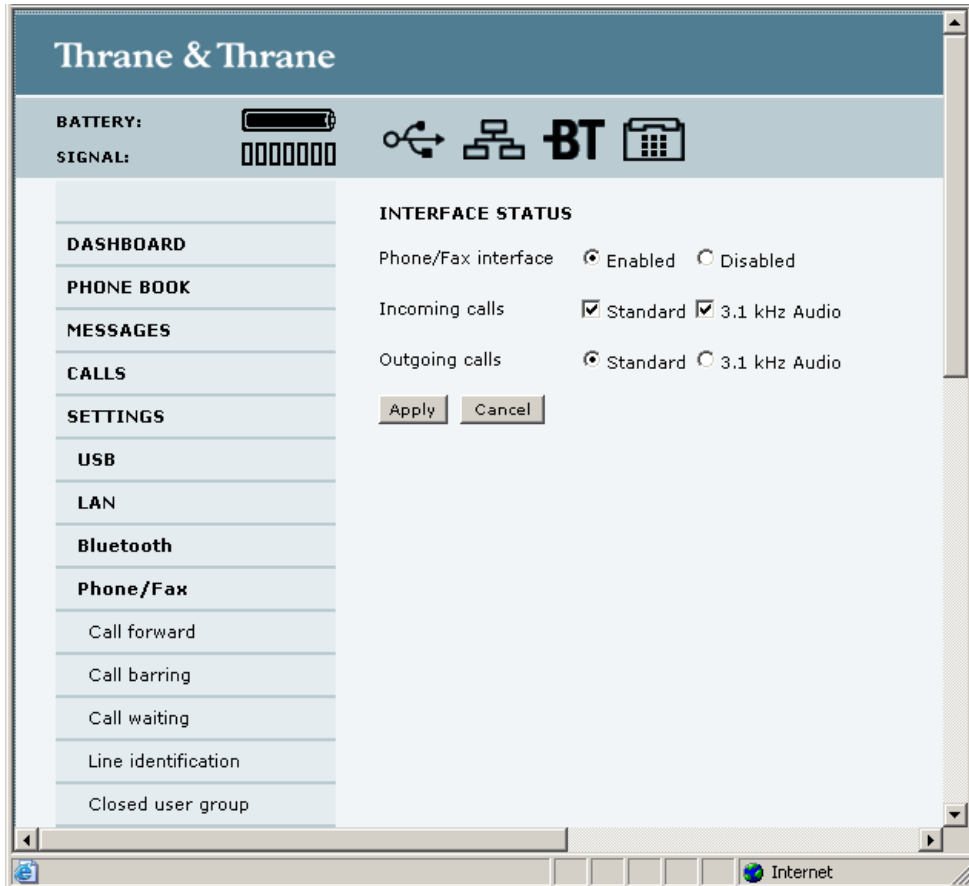

2. Select **Enabled** or **Disabled** to enable/disable the Phone/Fax interface.
3. Set the voice quality for incoming and outgoing calls. Voice quality is described in more detail in *Selecting the call type* on page 52.
 - For **Incoming calls**, you can check Standard or 3.1 kHz Audio or both. If you check both, any device connected to the Phone/Fax interface will react (ring) on incoming calls. If you select e.g. Standard, the Phone/Fax interface will only react on calls made to the Standard phone number.
 - For **Outgoing calls**, you can select either Standard or 3.1 kHz Audio. The selected quality will be used by default, if possible, for any outgoing call. Note, however, that fax machines and modems must use 3.1 kHz Audio.

Note You can override the default setting for outgoing calls by dialing 1* (force the call to Standard) or 2* (force the call to 3.1 kHz Audio) before the number. For further information, see *Overriding the default outgoing call type* on page 52.

4. Click **Apply**.

Setting up call services

Overview

Note The EXPLORER 500 must be registered on the BGAN network before you can set up the call services in the web interface.

In the web interface you can set up the following supplementary services:

- Call forwarding
- Call barring
- Call waiting
- Line identification
- Closed user group

Note that some active supplementary service settings may prevent other supplementary service settings from being activated.

Call forwarding

You can forward incoming calls to another phone number. Do as follows:

1. Select **Settings > Phone/Fax > Call forward** from the left navigation pane.

2. For each call type, select **Enabled** next to the situation(s) in which you want to forward incoming calls.
3. Next to the enabled items, type in the phone number you want to forward the call to.
4. If you have selected **Forward if no reply**, select from the drop-down list the period of time the system should wait before forwarding the call.
5. Click **Apply**.

Call barring

You can bar incoming and/or outgoing calls to and from the EXPLORER 500.

Do as follows:

1. Select **Settings > Phone/Fax > Call barring** from the left navigation pane.



2. Click **OK** next to **Read current settings**, to make sure the window is updated.
3. For each call type, select which calls should be barred.

- In the **Barring PIN** field at the bottom, type in a PIN for your call barring setup.

Note This is **not** the SIM PIN entered at startup, but a second PIN which is supplied together with your SIM PIN.

- Click **Apply**.

Call waiting

You can set up whether or not you want to receive notification of waiting calls while you are making a call or transmitting data on the Phone/Fax interface.

Do as follows:

- Select **Settings > Phone/Fax > Call waiting** from the left navigation pane.

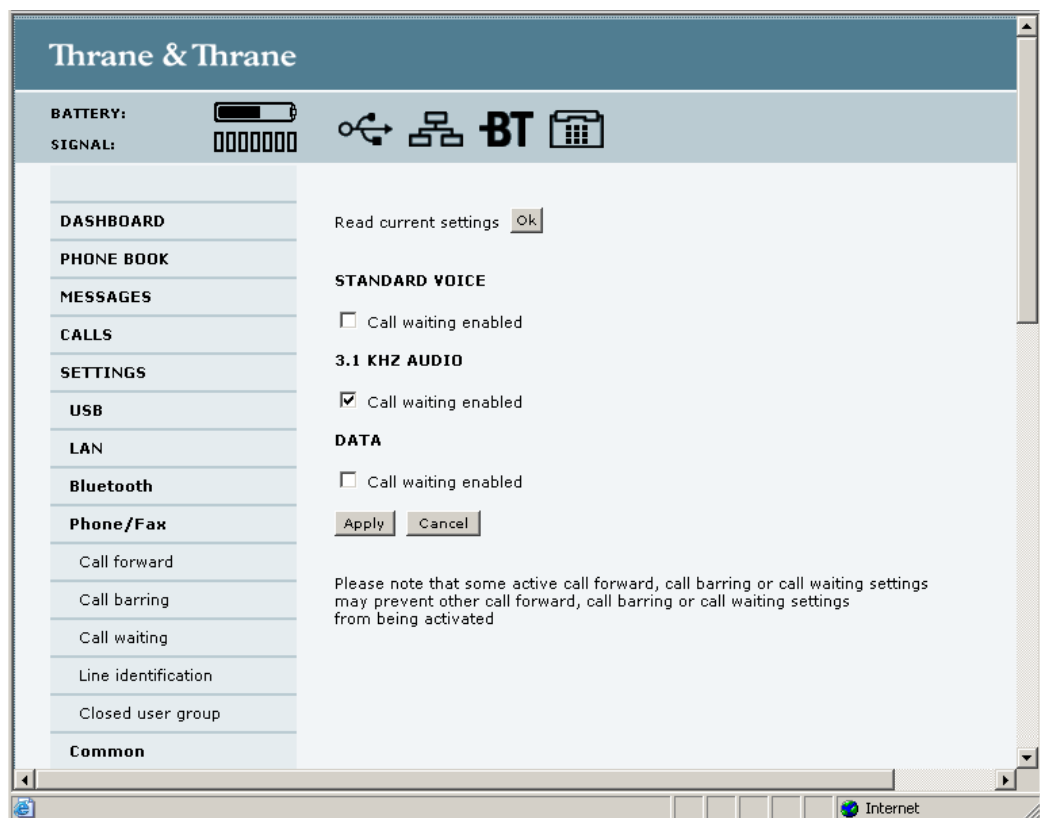

- Click **OK** next to **Read current settings** to make sure the window is updated.
- For each call type, select **Call waiting enabled** if you want to get notification of waiting calls while you are making a call or transmitting data on the Phone/Fax interface.
- Click **Apply**.

Line identification

You can set up the terminal to show your number when you are making a call or transmitting data on the Phone/Fax interface.

Do as follows:

1. Select **Settings > Phone/Fax > Line identification** from the left navigation pane.

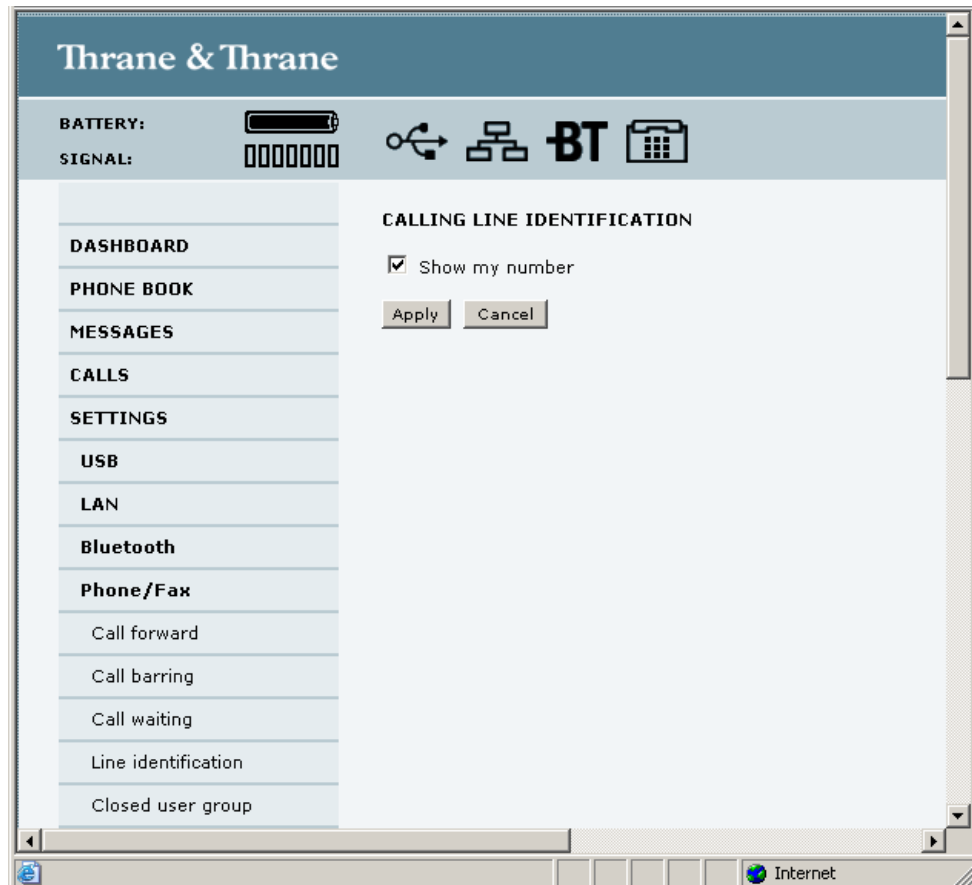

2. Select **Show my number** and click **Apply**.

Closed user group

Your subscription may include one or more closed user groups. A closed user group is a group of users permitted to make calls to each other but not to users outside the group.

To define the settings for these user groups, do as follows:

1. Select **Settings > Phone/Fax > Closed user group** from the left navigation pane.



2. Type in your user group number(s) under **Group no.**
3. Select which group(s) should be active.
If you select **Subscribed**, the group(s) included in your subscription will be active.
4. To allow outgoing access for the activated user group(s), select **Outgoing Access** under **SETTINGS FOR ACTIVE CLOSED USER GROUP**. Note that if you selected Subscribed above, this setting will not be used.

5. Select **Preferential** if you want the activated user group to be selected when a member of a user group does not specify the group number during call set up. Note that if you selected Subscribed above, this setting will not be used.
6. Click **Apply**.

Setting a common APN

Setting the common APN

The common APN setting is defined here and can be selected for each interface. If you are using the same APN for many interfaces, it is easier to define it once, and then simply select it for the relevant interfaces. Also, if you change the common APN at a later stage, it is automatically updated for all interfaces where the Common setting is selected.

To set a common APN, do as follows:

1. Select **SETTINGS > Common**.
2. Select the **APN**. You have the following options:
 - **SIM default**. The APN is taken from the SIM card. This is the recommended option, unless you have special requirements.
 - **Network assigned**. The APN is assigned from the network.
 - **User defined**. Type in the APN. APNs are provided from the Airtime Provider.
3. If your APN uses a password, type in the user name and password provided from the Airtime Provider.
4. Click **Apply**.

How to use the common APN

When you configure your individual interface, select **Common** to use the setting from this window.

Where Common is selected in the individual interface settings, the setting will automatically be updated when the Common APN is changed.

Selecting the GPS antenna

Note This feature is only available in software version 1.07 and greater.

The EXPLORER 500 can obtain the GPS position in two ways: Using the built-in GPS antenna or using the BGAN I-4 antenna.

If the terminal is placed in an open location with a wide view to the sky, the GPS antenna is the better choice, because it is omnidirectional.

If, however, the terminal is placed in a location with a limited view, e.g. close to a wall or similar, the I-4 antenna is better, because it is directional.

To select which GPS antenna to use for acquiring the GPS position, do as follows:

1. Select **SETTINGS > Advanced** from the left navigation pane.

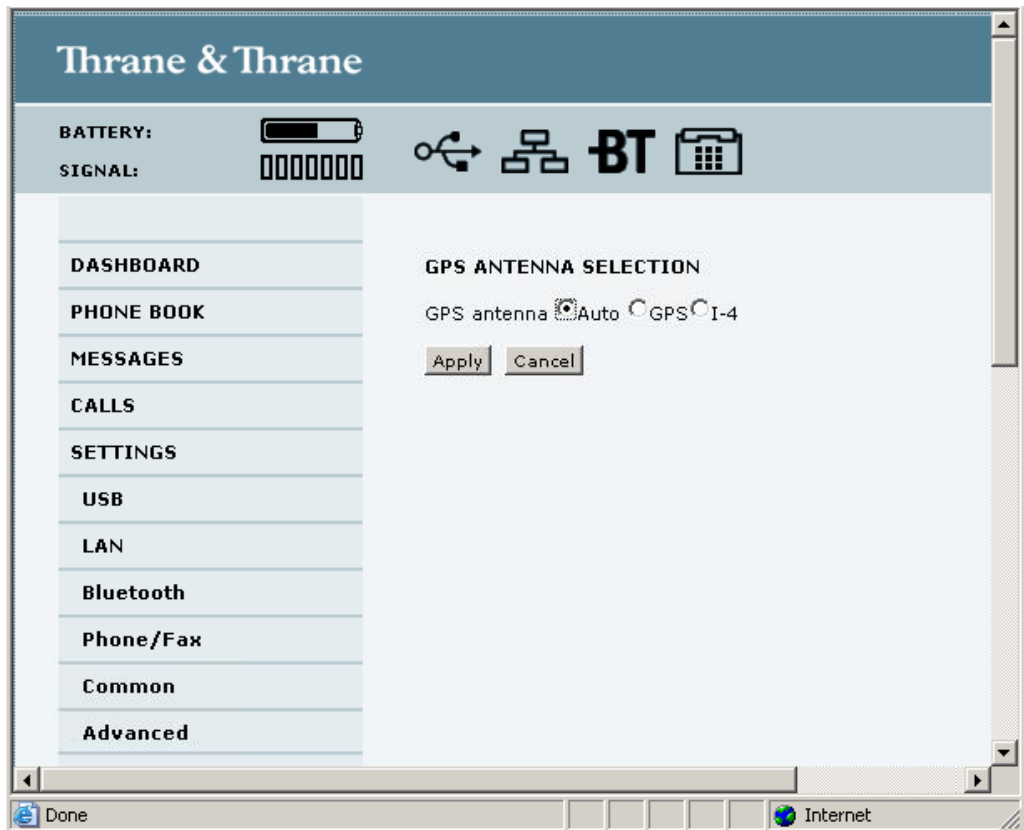

2. Select which antenna to use when acquiring the GPS position. You have the following options:
 - **Auto.** The standard factory setting is used.
 - **GPS.** The internal GPS antenna of the EXPLORER 500 is used for acquiring the GPS position (best in open areas).
 - **I-4.** The BGAN I-4 antenna is used for acquiring the GPS position (best in areas with a limited view to the sky).
3. Click **Apply**.

Setting the language

You can select the language to use in the web interface and the display menus of the EXPLORER 500. Do as follows:

1. Select **SETTINGS > Language**.



2. Select the language you want to use. Available languages are:
 - English
 - French
 - German
 - Russian
 - Spanish
3. Click **Apply** and restart your browser.
The web interface and the display menus now use the selected language.

Properties, software upload and alarm list

Viewing the properties of the EXPLORER[®] 500

To view the properties of the EXPLORER 500, select **PROPERTIES** from the left menu.

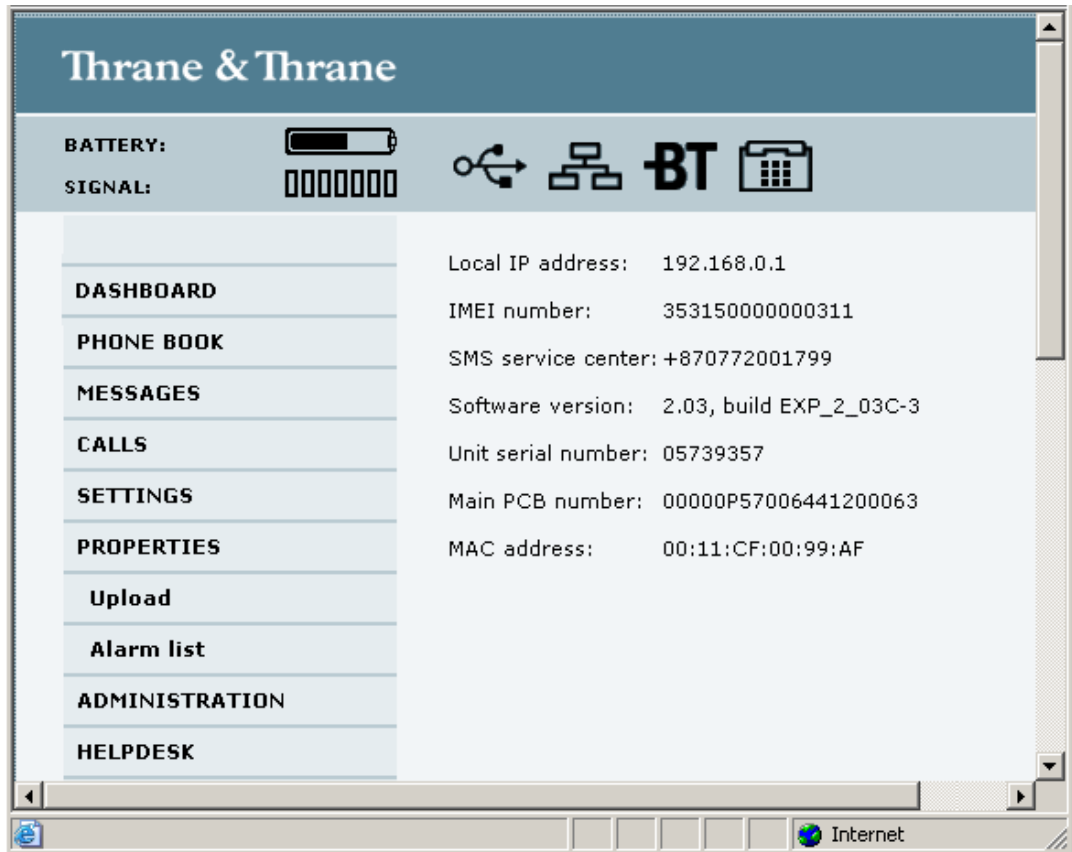

The PROPERTIES window shows:

- **Local IP address.** The local IP address of the EXPLORER 500.
- **IMEI number.** The IMEI number (International Mobile Equipment Identity) of the EXPLORER 500. This is a unique number that identifies your EXPLORER 500.
- **SMS service center.** A number used to identify the SMS service center used by your EXPLORER 500 to send and receive SMS messages.
- **Software version.** The version of the software embedded in the EXPLORER 500.
- **Unit serial number.** The serial number of the total unit.
- **Main PCB number.** The number of the Main PCB in the EXPLORER 500.
- **MAC address** of the EXPLORER 500.

Uploading software

Introduction

You can upload software from your computer to the EXPLORER 500 without entering the PIN. However, if the PIN is not entered, you must enter the Administration user name and password.

The web interface also offers the possibility of downloading the latest software version from the Internet to your computer.

Uploading software from your computer

To upload software from your computer to the EXPLORER 500, do as follows:

1. Download the new software as described in the next section, or acquire the software version from Thrane & Thrane and save it on your computer.
1. Open the web interface and select **PROPERTIES** from the left navigation pane.
2. Click **Upload** from the left navigation pane.
If you have not entered the PIN at start-up, you are prompted for an Administration user name and password.
3. If required, type in the Administration user name and password and click Logon.
The default user name is **admin** and the default password is **1234**.
The SOFTWARE UPLOAD page opens.

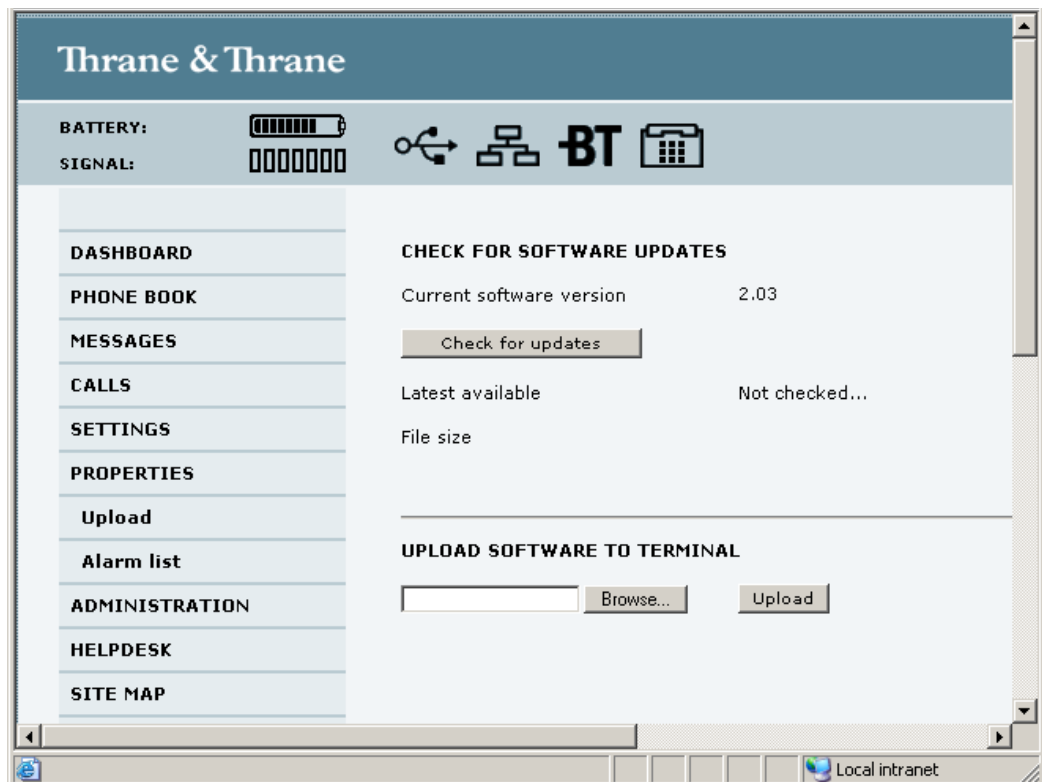

4. In the field **UPLOAD SOFTWARE TO TERMINAL**, click **Browse...**
5. Browse to the new software version and accept it.
6. Click the **Upload** button.
Note that the upload procedure takes a couple of minutes.

Note When upload is done, your EXPLORER 500 automatically restarts with the new software.

Downloading software from the Internet

To download the latest software from the Internet to the EXPLORER 500, do as follows:

1. Make sure you have a connection to the Internet from your EXPLORER 500.
2. Open the web interface and select **PROPERTIES** from the left navigation pane.
3. Click **Upload** from the left navigation pane.

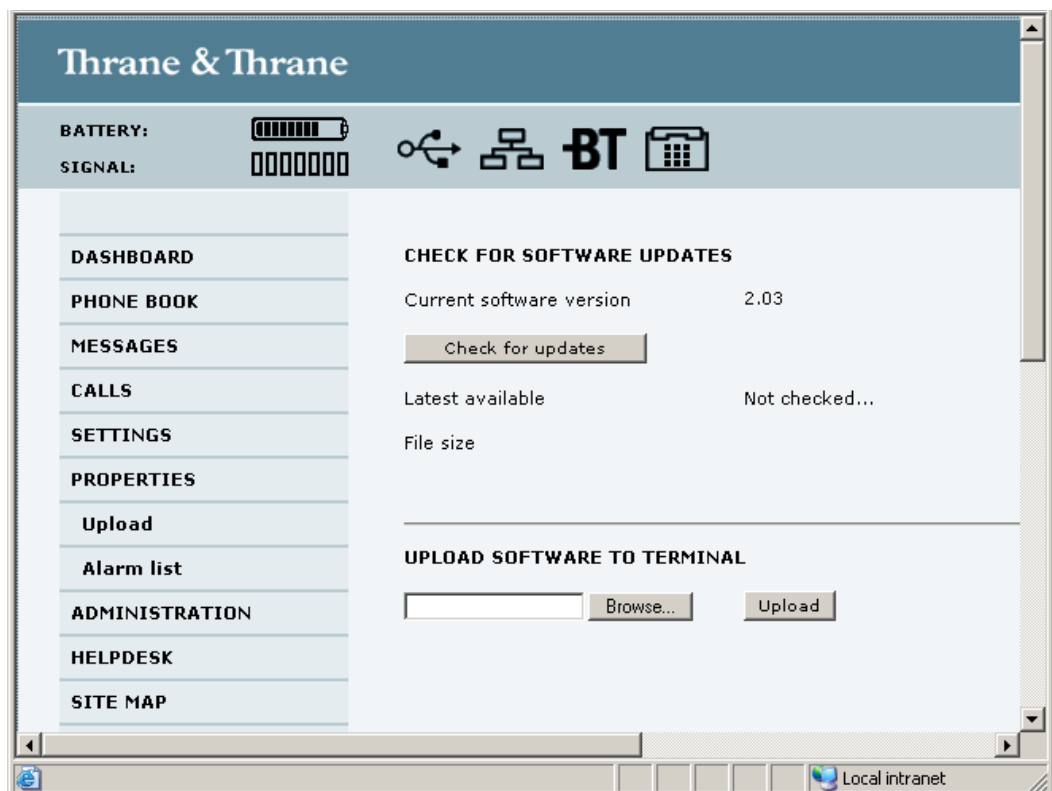

4. Click **Check for updates**.
The EXPLORER 500 will now connect to the Internet through the BGAN network, using your airtime subscription. It may take a minute or two to obtain the new software version. When the new software version is found, the web interface shows the new software version and a link for downloading the software to your computer.

5. Click the link to download the new software to your computer.

Important

The EXPLORER 500 uses your BGAN airtime subscription to download the new software from the Internet. Note that it can take several minutes to download the software.

After saving the software on your computer, follow the procedure in the previous section (*Uploading software from your computer*) to upload the software from the computer to your EXPLORER 500.

Viewing the Alarm List

When an alarm is issued, the web interface shows an alarm icon  in the icon bar.

To view the Alarm list, click the alarm icon from the icon bar at the top of the web interface or select **Properties > Alarm list** from the left navigation pane.

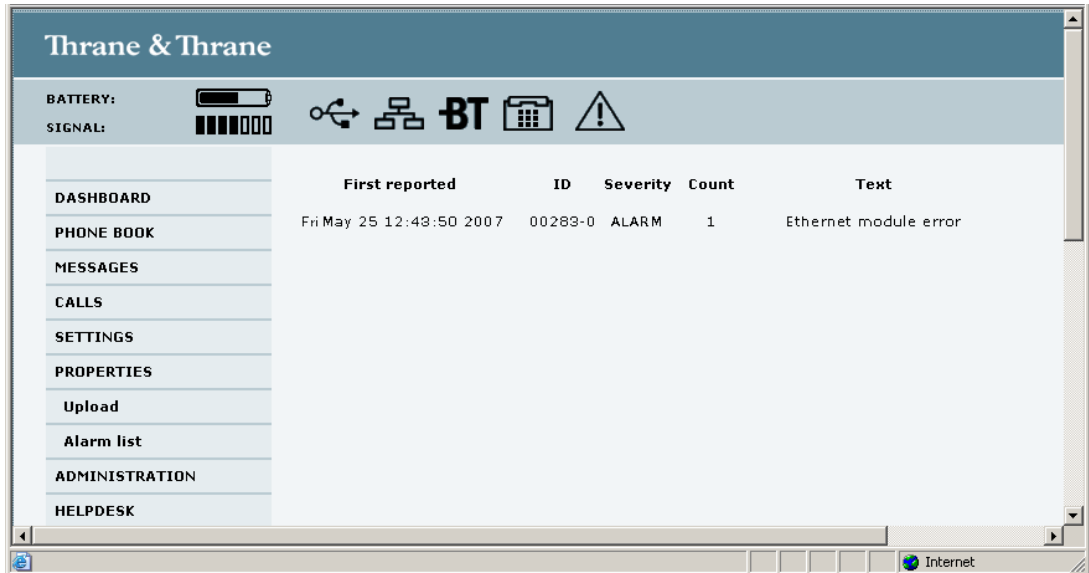

The Alarm list window shows a detailed list of active alarms including the time of the first occurrence, ID and severity of the alarm message, number of occurrences and a short text describing the error. For more information on the alarm messages, refer to *Alarm messages* on page 149.

If you need to report the alarms for service purposes, make sure you include the complete ID number. This number is used by service personnel to uniquely identify an alarm.

Administration

Accessing the administration settings

Logging on

The Administration settings require an Administration user name and password.

1. Select **ADMINISTRATION** from the left navigation pane.
2. Enter the Administration user name and password.
The default user name is **admin** and the default password is **1234**.

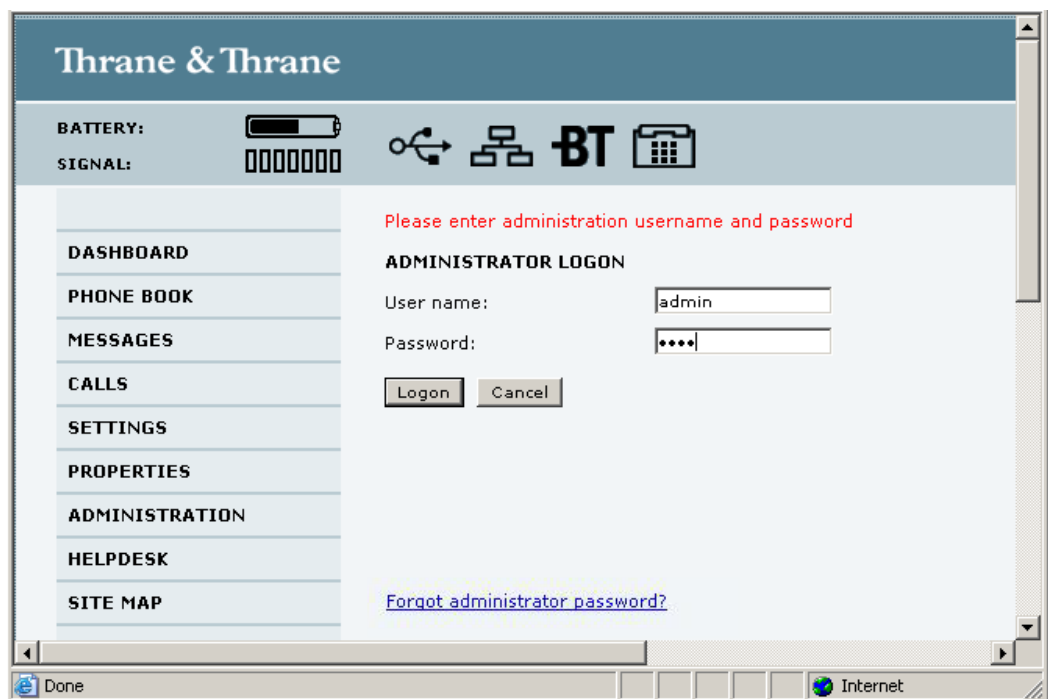

In software version 1.07 and greater, if you have forgotten the administrator password, you can reset the password by clicking the link at the bottom of the window. For further information, see the next section *Resetting the Administrator password*.

3. Click **Logon**.
The Administration window is now updated to let you change the user name and password, Save/load a configuration or log off Administration.

Resetting the Administrator password

Note This feature is only available in software version 1.07 and greater.

If you have forgotten the administrator password, do as follows:

1. Contact your supplier for a reset code.
Please report the serial number and IMEI number of the terminal.
2. Click the link **Forgot administrator password?** at the bottom of the ADMINISTRATOR LOGON window (see the previous section).

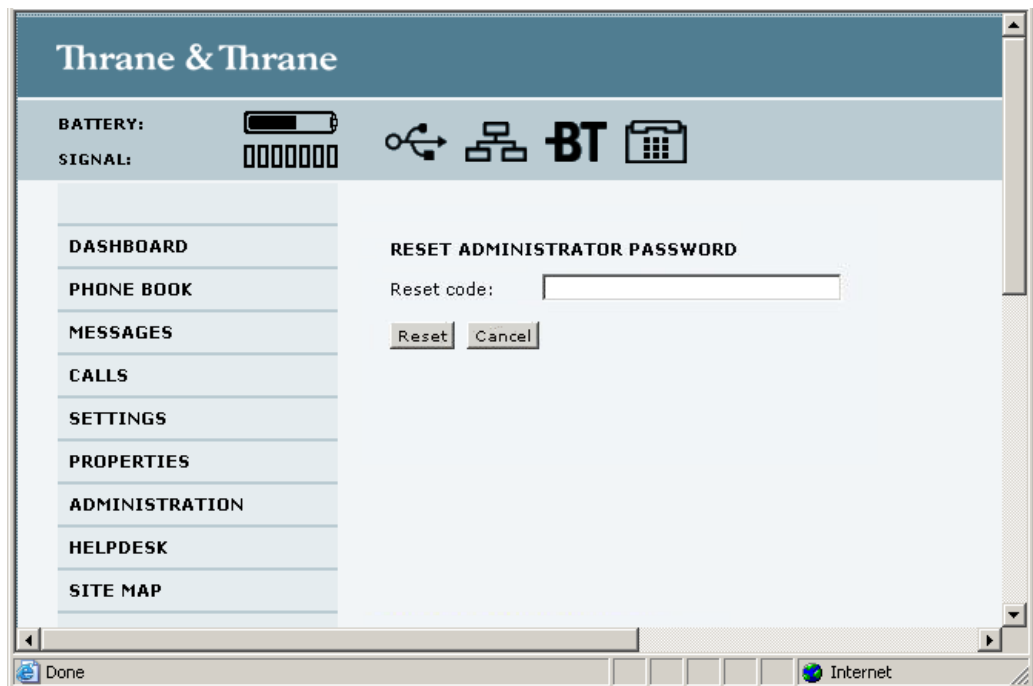

3. Type in the reset code obtained from your supplier and click **Reset**.
4. Type in the user name **Admin** and the default password **1234**.
5. Click **Logon**.
For information on how to change the password, see the next section *Changing the administrator password*.

Changing the administrator password

Do as follows:

1. After entering the Administrator user name and password in the ADMINISTRATION window, locate the section **Change administrator logon**.

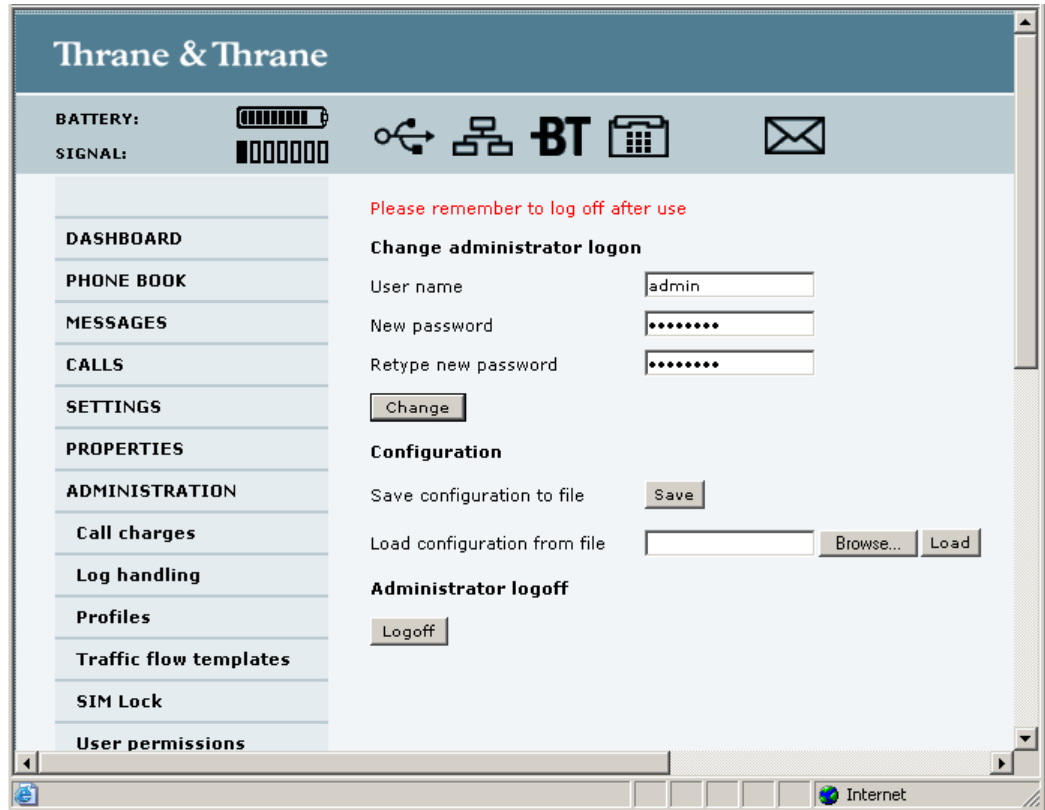

2. Type in the existing user name.
3. Type in the new password and retype the password on the next line.
4. Click **Change**.
At the next logon the new password is required.

Saving a configuration to a file

If you need to reuse a configuration in another EXPLORER 500, you can save your current configuration to a file, which can then be loaded into the other EXPLORER 500.

Do as follows:

1. In the **ADMINISTRATION** window, under Configuration, click **Save**.
2. Accept the default destination file name or type in the destination file name and location.
3. Click **OK**.
The configuration is now saved to a file. This file is used to load the configuration into another EXPLORER 500. See the next section.

Loading a configuration from a file

1. In the **ADMINISTRATION** window, under Configuration, click **Load**.
2. Click **Browse...** to browse to the file you want to import. Then click **Open**.
3. Click **Load**.
The new configuration is now loaded into your EXPLORER 500.

Logging off administration

If you have not entered anything for 30 minutes under ADMINISTRATION, you are logged off automatically.

To log off manually, click **Logoff** under Administrator logoff in the **ADMINISTRATION** window.

Call charges

If you know the tariff for your subscribed services, you can enter these tariffs in the web interface and automatically calculate the charges for your calls and data sessions.

Note Thrane & Thrane does not take responsibility for the correctness of the estimated charges. This calculation is only a rough estimate of the charge, based on the tariff entered by the user. Also, the Airtime Provider may have different methods of calculating the charge.

Do as follows:

1. From the left navigation pane, select **ADMINISTRATION > Call Charges**
2. Select the currency from the Currency drop-down list.
3. Enter the tariff for each of the services.
4. Click **Apply**.

The entered tariffs are used for estimating the charges for calls and data sessions. The estimated charge is listed for each call or data session in the call log. For further information, see *Viewing the lists of calls* on page 85.

Log handling

1. From the left navigation pane in the **ADMINISTRATION** window, select **Log Handling**.

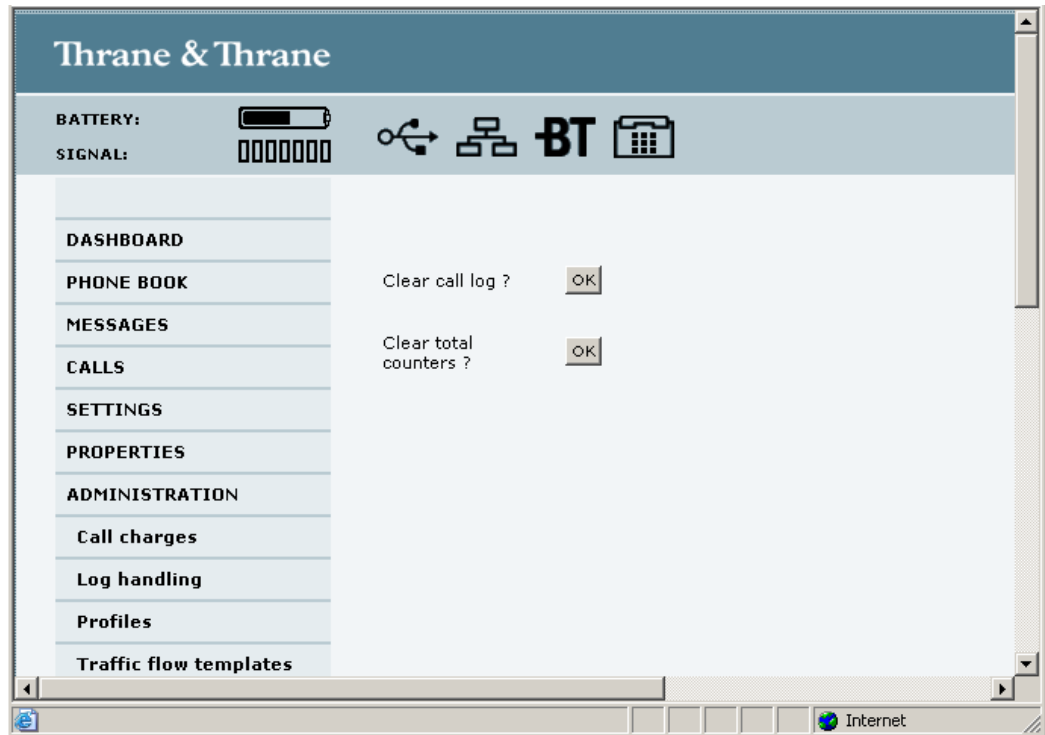

2. To clear the **Call log**, click **OK** next to **Clear call log?**
3. To clear the **total counters**, click **OK** next to **Clear total counters?**. This will reset the **Time connected** counters on the Calls page.

Using Profiles

What is a Profile?

A Profile is a collection of Quality of Service (QoS) settings and other settings defining the mode in which data is transmitted on an interface. For example, a Profile is used to define whether the connection is a Streaming connection or a Standard connection.

You can select between a number of predefined Profiles or define your own Profiles for your data transmission.

If no Traffic Flow Template (TFT) is defined, the Primary Profile for an interface is used for all traffic on that interface. See *What is a Traffic Flow Template?* in the next section.

For further information on Profiles, refer to the 3GPP standard TS 23.107.

Selecting the Profiles for an interface

When you set up your interface, you select the Profiles to use for that interface. You select a Primary Profile and optionally one or more Secondary Profiles.

For further information on how to select the Profiles, see the “Configuring...” sections for the individual interfaces in this chapter.

Defining new Profiles

When you define your Profiles you can select **Subscribed** for many of the settings. If you select Subscribed, the value given in your Airtime subscription will automatically be used.

To define a new Profile, do as follows:

1. From the left navigation pane, select **ADMINISTRATION > Profiles**.

	Standard	Streaming 32	Streaming 64	Streaming 128	User defined 1	User defined 2	User defined 3
Traffic class	Background	Streaming	Streaming	Streaming	Subscribed	Subscribed	Subscribed
Maximum bit rate UL (kbps)	0	32	64	128	0	0	0
Maximum bit rate DL (kbps)	0	32	64	128	0	0	0
Guaranteed bit rate UL (kbps)	0	32	64	128	0	0	0
Guaranteed bit rate DL (kbps)	0	32	64	128	0	0	0
Delivery order	Subscribed	Subscribed	Subscribed	Subscribed	Subscribed	Subscribed	Subscribed
Maximum SDU size (Byte)	0	0	0	0	0	0	0
SDU error ratio	Subscribed	Subscribed	Subscribed	Subscribed	Subscribed	Subscribed	Subscribed
Residual bit error ratio	Subscribed	Subscribed	Subscribed	Subscribed	Subscribed	Subscribed	Subscribed
Delivery of erroneous SDUs	Subscribed	Subscribed	Subscribed	Subscribed	Subscribed	Subscribed	Subscribed
Transfer delay (ms)	0	0	0	0	0	0	0
Traffic handling priority	Subscribed	Subscribed	Subscribed	Subscribed	Subscribed	Subscribed	Subscribed

2. In one of the **User defined** columns, fill in the top field with the name of your Profile.
3. In the **Traffic class** row of your new Profile, select a class from the drop-down list.

Important

For best performance, choose the right traffic class for your application. In general, Standard data (Background) is best suited for TCP/IP applications, and Streaming data is best suited for UDP traffic, e.g. live video or audio.

You may select one of the following:

- **Conversational** is real-time two-way conversation. It is primarily used for voice over IP and video conferencing.
- **Streaming** is real-time one-way communication. It is primarily used for video and audio.
- **Interactive** is two-way communication (not real-time). It is used for communication that is not very delay-sensitive, such as web browsing, data base retrieval and server access.

Examples of machines interaction with remote equipment are: polling for measurement records and automatic data base enquiries (tele-machines).

- **Background** is used for data which is not delay-sensitive, such as E-mails, SMS, download of databases and reception of measurement records.

4. Type in the bit rates in kbps in the following rows:

- **Maximum bit rate ul (kbps)** is the maximum upload bit rate allowed for this Profile.
- **Maximum bit rate dl (kbps)** is the maximum download bit rate allowed for this Profile.
- **Guaranteed bit rate ul (kbps)** is the guaranteed upload bit rate needed for this Profile.
- **Guaranteed bit rate dl (kbps)** is the guaranteed download bit rate needed for this Profile.

Note When you click Apply, the bit rate values you typed in may be rounded off because only certain values are allowed.

5. In the **Delivery order** row, select from the scroll list whether or not data should be delivered in the same order it was sent. Yes means the data packets are delivered in the same order they were sent.
6. In the **Maximum SDU size (byte)** row, type in the maximum allowed packet size in Bytes (rounded off to nearest 10). The maximum packet size possible is 1520.
7. In the **Delivery of erroneous SDUs** row, select one of the following from the list:
 - **Yes** means packets are allowed to contain errors. This setting is suitable for delay-sensitive transmission, because the need for retransmission is limited. The SDU Error settings in step 8. and step 9. will apply.
 - **No** means packets are not allowed to contain errors, and the SDU Error setting in step 8. will **not** be applied. This setting is suitable where error-free transmission is important and delays are accepted.
 - **No detect** means that errors will not be detected, and the SDU Error setting in step 8. will **not** be applied.
8. If you selected **Yes** in step 7., select from the **SDU error ratio** drop-down list the fraction of a packet allowed to be lost or erroneous.
9. Select from the **Residual bit error ratio** drop-down list the undetected bit error ratio of a packet. If no error detection is requested, Residual bit error ratio indicates the bit error ratio in the delivered packets.
10. In the **Transfer delay (ms)** row, type in the delay in ms. This is the delay from data is received in the EXPLORER 500 until it arrives at the receiving end.
11. In the **Traffic handling priority** row, select from the drop-down list which priority this connection should have.
12. Click **Apply**.
The new Profile is now added, and can be selected from the lists of primary and secondary Profiles when you set up your interfaces.

Using a Traffic Flow Template

What is a Traffic Flow Template?

A Traffic Flow Template (TFT) is a packet filter list allowing the Core network and the EXPLORER 500 to classify packets received from the external network into the proper PDP (Packet Data Protocol) context.

A TFT consists of from one and up to eight packet filters, each identified by a unique packet filter identifier. A packet filter also has an evaluation precedence index that is unique within all TFTs associated with the PDP contexts that share the same PDP address.

Information of source, destination, type of service etc. is combined in each packet filter in the TFT.

Purpose of the Traffic Flow Template

The purpose of the TFT is to assign different priorities to different types of traffic, in order to optimize performance.

Example: When you are browsing the Internet, a Standard data connection will normally be sufficient. However, if you need to have a video conference, you may need to use a Streaming connection, in order to obtain a direct connection without interruptions. Your Traffic Flow Template can define these priorities, so that your connection automatically switches to Streaming e.g. when you have a video conference.

Defining the Traffic Flow Template

To define a new template, do as follows:

1. From the left navigation pane, select **ADMINISTRATION > Traffic Flow Templates**.
2. Select which filters should apply to which Profiles.
The filters are defined in the Traffic flow filters list. Refer to the next section
3. Click **Apply**.

Defining filters for the Traffic Flow Template

To define the filters used in the Traffic flow template, do as follows:

- From the left navigation pane, select **ADMINISTRATION > Traffic Flow Templates > Traffic flow filters.**

	Eval. Prec. Index	Source Address	Subnet Mask	Prot. No.	Dest. Port Range From	Dest. Port Range To	Source Port Range From	Source Port Range To	Type of Service	Type of Service Mask
Filter 1	<input type="checkbox"/>	<input type="text"/>	<input type="text"/>	<input type="text"/>	<input type="text"/>	<input type="text"/>	<input type="text"/>	<input type="text"/>	<input type="text"/>	<input type="text"/>
Filter 2	<input type="checkbox"/>	<input type="text"/>	<input type="text"/>	<input type="text"/>	<input type="text"/>	<input type="text"/>	<input type="text"/>	<input type="text"/>	<input type="text"/>	<input type="text"/>
Filter 3	<input type="checkbox"/>	<input type="text"/>	<input type="text"/>	<input type="text"/>	<input type="text"/>	<input type="text"/>	<input type="text"/>	<input type="text"/>	<input type="text"/>	<input type="text"/>
Filter 4	<input type="checkbox"/>	<input type="text"/>	<input type="text"/>	<input type="text"/>	<input type="text"/>	<input type="text"/>	<input type="text"/>	<input type="text"/>	<input type="text"/>	<input type="text"/>
Filter 5	<input type="checkbox"/>	<input type="text"/>	<input type="text"/>	<input type="text"/>	<input type="text"/>	<input type="text"/>	<input type="text"/>	<input type="text"/>	<input type="text"/>	<input type="text"/>
Filter 6	<input type="checkbox"/>	<input type="text"/>	<input type="text"/>	<input type="text"/>	<input type="text"/>	<input type="text"/>	<input type="text"/>	<input type="text"/>	<input type="text"/>	<input type="text"/>
Filter 7	<input type="checkbox"/>	<input type="text"/>	<input type="text"/>	<input type="text"/>	<input type="text"/>	<input type="text"/>	<input type="text"/>	<input type="text"/>	<input type="text"/>	<input type="text"/>
Filter 8	<input type="checkbox"/>	<input type="text"/>	<input type="text"/>	<input type="text"/>	<input type="text"/>	<input type="text"/>	<input type="text"/>	<input type="text"/>	<input type="text"/>	<input type="text"/>
Filter 9	<input type="checkbox"/>	<input type="text"/>	<input type="text"/>	<input type="text"/>	<input type="text"/>	<input type="text"/>	<input type="text"/>	<input type="text"/>	<input type="text"/>	<input type="text"/>
Filter 10	<input type="checkbox"/>	<input type="text"/>	<input type="text"/>	<input type="text"/>	<input type="text"/>	<input type="text"/>	<input type="text"/>	<input type="text"/>	<input type="text"/>	<input type="text"/>

Then fill in the details for each traffic flow filter as described below.

- Type in an Evaluation Precedence Index in the **Eval.Prec. Index** column.

Note This field is mandatory. Each filter must have a different Evaluation Precedence Index.

- Fill in one or more of the following fields to define the filter. The allowed ranges appear in hover text when you pass the mouse over the fields.
 - **Source address + Subnet mask.**
 - **Protocol number.**
 - **Destination port range** (From and To). Note that Source and Destination are relative the core network. This means that Destination is your EXPLORER 500 terminal.
 - **Source port range** (From and To).
 - **Type of Service + Type of Service mask.**

For further information on the principles and parameters of the Traffic Flow Template, refer to the 3GPP standards TS27.007 V4.2.0 and TS 23.060 V4.7.0.

- Click **Apply** at the bottom of the window. The new settings are included if you select the filter in the Traffic flow template window.

Setting up user permissions

You can restrict access to parts of the web interface for non-administrator users.

To set up the user permissions, do as follows:

1. From the left navigation pane, select **ADMINISTRATION > User permissions**.

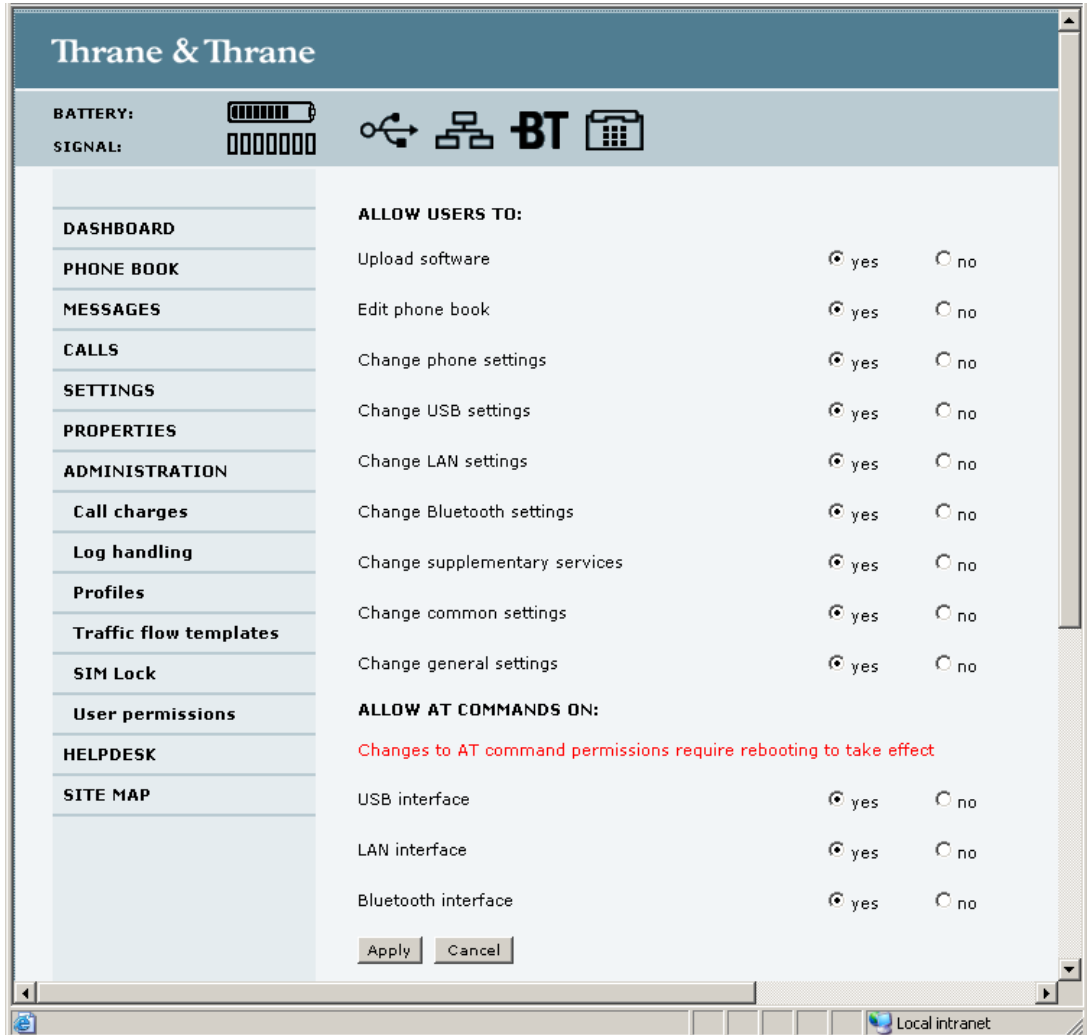

2. For each item under **ALLOW USERS TO:**, select
 - **yes** to allow access or
 - **no** to block access to the settings.
3. For each of the listed interfaces under **ALLOW AT COMMANDS ON:**, select
 - **yes** to allow the use of AT commands, or
 - **no** to block the use of AT commands on that interface.

Note that this setting does not take effect until the EXPLORER 500 is restarted.
4. Click **Apply**.
The settings to which access is denied are greyed out for the non-Administrator user.

Help desk and diagnostic report

Accessing the Help desk

If you need help **with airtime-related issues** you may call the Help desk. By default, the Help desk is the phone number for your Airtime Provider, if it is available on the SIM card.

Select **HELP DESK** from the left navigation pane.

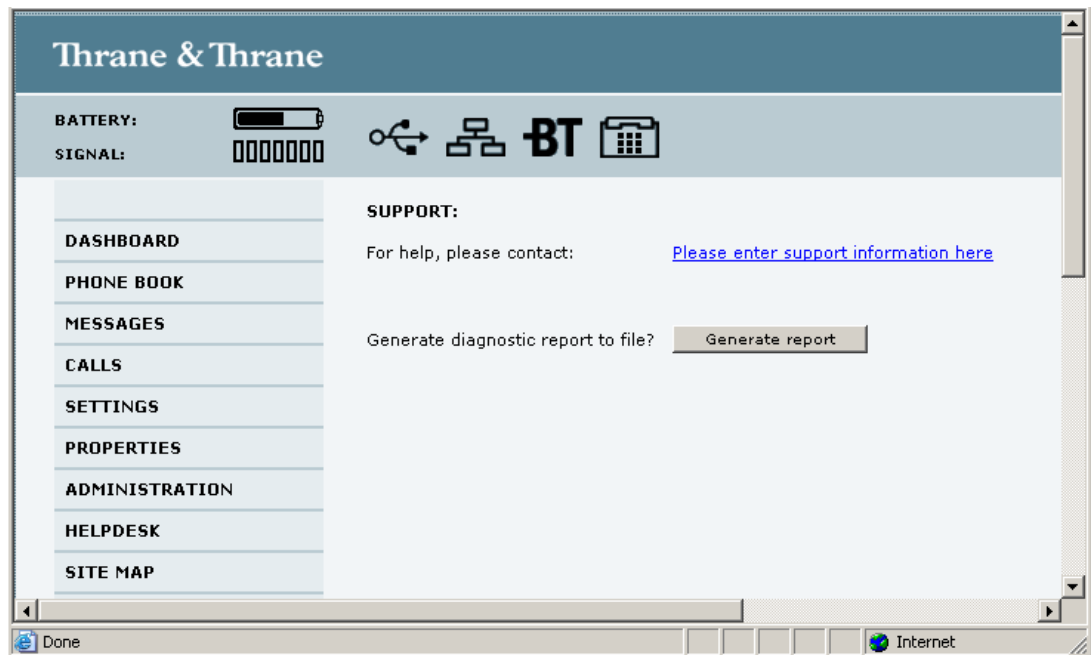

If the Help desk number is available on the SIM card, the number is displayed as a link. To change the number, click the link, change the number and click **Apply**.

If you need help **with EXPLORER 500 issues** you should call your [local distributor](#).

Generating a diagnostic report

If you want to generate a diagnostic report, do as follows:

1. Click **Generate report** from the **HELP DESK** window.
In some browsers the file may open directly in your browser. If it does, choose **File > Save As** to save the file.
2. Choose a location for the file and save it.

The diagnostic report contains relevant information for troubleshooting. Please enclose this file when you are reporting an error.

What's next?

This chapter has explained how to use the web interface for setup and use of the EXPLORER 500. You should now be able to set up the EXPLORER 500, pair Bluetooth devices, check status, read and send SMS messages, use the phone book and much more.

The following chapter, *Maintenance and troubleshooting*, provides guidelines for troubleshooting and for general maintenance.

Maintenance and troubleshooting

In this chapter

This chapter gives guidelines for troubleshooting and for general maintenance. It also provides an overview of the different means of status signaling,

Getting support

Overview

If this manual does not provide the information required to solve your problem, you may want to contact your Airtime Provider or your local distributor.

Airtime support

If you need assistance from your Airtime Provider, please call the help desk. To see the help desk number, enter the display menu system or the web interface of your EXPLORER 500 and select **HELP DESK**. This help desk number is either taken from the SIM card or entered manually. If no number is available under HELP DESK, check your Airtime subscription for a contact number.

EXPLORER[®] 500 support

If you need assistance with problems caused by the EXPLORER 500, please call a distributor in your area.

[Click this link to see a list of Thrane & Thrane distributors.](#)

Note

The list of distributors is located on the EXPLORER 500 CD-ROM delivered with your EXPLORER 500, so it may not always be up to date.

An updated list is available on Thrane & Thrane's web site: www.thrane.com. Click **Land Mobile** and select **Distributors** from the top menu bar.

Uploading software

Viewing software version status

To view the version of the embedded software in the EXPLORER 500, select **DASHBOARD** in the web interface or **PROPERTIES** in the display menus and see **Software information**.

Uploading software using the web interface

You can upload software from the **SETTINGS > Upload** window in the web interface.

If you have an Administrator user name and password you do not need to insert a SIM card nor to enter the PIN to be able to upload software.

For further information, see *Uploading software* on page 121.

Maintenance

Normal use of the battery

It is recommended **not** to partially charge/discharge the battery several times in a row. Partial charging/discharging affects the accuracy of the capacity measurement.

Never leave the battery fully discharged for a longer period of time. If the battery is not to be used for a shorter period of time (1 month), charge the battery to minimum 20 to 30% and remove it from the EXPLORER 500. If the Battery is stored for more than a month, see *Storage* at the end of this section.

Recharging the battery

To recharge the battery, insert it into the EXPLORER 500 and connect the EXPLORER 500 to power.

The indicator left to the display is constantly green as long as the battery is charging. When the battery is fully recharged, the green indicator is turned off. If the EXPLORER 500 is switched on, the green indicator will be flashing shortly every 2 seconds.

If a charging error occurs, the green indicator on the EXPLORER 500 flashes rapidly. See the *Troubleshooting Guide* on page 142.

Accurate display of the battery capacity

To ensure accurate display of the battery capacity, it is recommended to run a “learning cycle” for every 100 recharge/discharge and at first time use. The learning cycle must be performed at 20°C-30°C.

A learning cycle is performed as follows:

1. Fully charge the battery.
2. Remove external power and fully discharge the battery:
Use the EXPLORER 500 and/or leave it on until it turns off automatically.
This way the EXPLORER 500 “learns” the complete capacity of the battery.
Note that it may take up to 36 hours to discharge the battery if it is not in use.
3. Recharge the battery.

Storage

Do not leave the battery inserted in the EXPLORER 500 during storage.

If the battery is not to be used for a longer period of time, do as follows:

1. Fully charge the battery.
2. Remove external power. Then use the EXPLORER 500 or leave it on until the display shows a battery capacity of approximately 50%.
3. Switch off the EXPLORER 500.

Important

Switch off the EXPLORER 500 **before** removing the battery!

4. Remove the battery and store it.

In this condition the battery can be stored for approximately 1 year at 20°C to 30°C. After 1 year you must recharge the battery. For further information on storage temperature, see *Battery* on page 156.

Disposal of the EXPLORER® 500

Old electrical and electronic equipment marked with this symbol can contain substances hazardous to human beings and the environment. Never dispose these items together with unsorted municipal waste (household waste).



In order to protect the environment and ensure the correct recycling of old equipment as well as the re-utilization of individual components, use either public collection or private collection by the local distributor of old electrical and electronic equipment marked with this symbol.

Contact the local distributor for information about what type of return system to use.

Options and accessories

The following options and accessories are available from Thrane & Thrane:

Item	Number
EXPLORER Bluetooth Handset + charger cable 	TT-3625A
Desktop charger cradle for EXPLORER Bluetooth Handset + power supply 	TT-3625A, Opt. 003
EXPLORER 500 Battery 	TT-3686L
EXPLORER 500 Softbag 	TT-3650A, Opt. 202
EXPLORER 500 Dummy Battery 	TT-3686F
EXPLORER 500 Car charger cable 	TT-3650A, Opt. 009
Pole mount kit for EXPLORER 500 	TT-3650A, Opt. 922
AC/DC adapter 	TT-3682L UP0501Q-15P

Troubleshooting guide

The below table provides information on some of the problems that might occur, including possible causes and remedies to solve the problems.

Problem	Possible Cause	Remedy
The EXPLORER 500 cannot be switched on, or does not stay on when powered by the battery.	The battery needs recharging.	Recharge the battery. Check the battery indicator in the display.
	The battery is not inserted properly.	Remove the battery and re-insert it. Make sure the battery is inserted properly and that the latch is locked.
	The battery contacts are dirty or damaged.	Clean the battery contacts if necessary. If the contacts are damaged, replace the battery.
There is no light in the power indicator nor in the display when the EXPLORER 500 is switched on.	The EXPLORER 500 may be in Stealth Mode (all lights and sounds are off).	Press C+OK on the display keypad. This will toggle Stealth Mode on/off.
The EXPLORER 500 cannot be switched off.	The Power button was not pressed long enough.	When you switch off the EXPLORER 500, hold the power button until the display shows "Switching off". In rare cases, it may take up to 10 seconds to switch off the EXPLORER 500.
Charging error - The green Power indicator flashes rapidly while the battery is being recharged.	The temperature is below 0°C or above 45°C.	Only charge the battery when the temperature is within the range 0°C to 45°C.
	The charging voltage is less than 9 V.	Wait until charging begins (the green Power indicator lights constantly). If the battery is completely discharged, and it has been out of use for a long time, the charging process may take a long time to start. If charging does not begin within 2-3 hours, contact your local distributor, or purchase a new battery.

Problem	Possible Cause	Remedy
The display shows INSERT SIM.	The SIM card is not present.	Remove the battery and insert the SIM card in the SIM slot according to the instructions in the section <i>Inserting the SIM card</i> on page 12.
	The SIM card is not inserted properly.	Remove the SIM card and re-insert it according to the instructions in the section <i>Inserting the SIM card</i> on page 12.
The display shows NO GPS.	The EXPLORER 500 is unable to register on the network, because the GPS position is unknown.	<p>Make sure the view to the GPS satellites is not blocked.</p> <p>To obtain GPS fix, the EXPLORER 500 should be placed flat on an even surface pointing straight upwards, with a clear view to as much of the sky as possible. When the EXPLORER 500 has obtained GPS fix, you can point the antenna towards the BGAN satellite.</p> <p>To see the GPS status, enter the menu system and select PROPERTIES > GPS STATUS.</p>
The display shows EMERGENCY ONLY.	<p>The BGAN network is only available for emergency calls.</p> <p>The reason may be one of the following:</p> <ol style="list-style-type: none"> 1) Your Airtime subscription has expired. 2) You are using the wrong SIM card. 	<ol style="list-style-type: none"> 1) Check your subscription with the Airtime Provider. 2) Check that your SIM card is valid for communication on the BGAN network.
The display shows NOT REGISTERED.	The EXPLORER 500 cannot register on the BGAN network.	<p>Check that your SIM card is valid for communication on the BGAN network.</p> <p>Check your subscription with the Airtime Provider.</p>

Problem	Possible Cause	Remedy
The EXPLORER 500 cannot obtain its position using GPS.	<p>There is no GPS signal, or the signal is weak.</p> <p>If the EXPLORER 500 has not been used recently within the same location, it can take up to 10 minutes to obtain the GPS position.</p>	<p>Check the GPS status in the display or the web interface.</p> <p>To help the EXPLORER 500 obtain GPS fix, it should be placed flat on an even surface pointing straight upwards, with a clear view to as much of the sky as possible.</p> <p>When the EXPLORER 500 has obtained GPS fix, you can point the antenna towards the BGAN satellite.</p>
No signal or weak signal from the BGAN satellite.	The view to the satellite is blocked.	Make sure the EXPLORER 500 has a clear view to the satellite. Be aware that window glass, trees, or even rain may reduce the signal level.
	The antenna is pointed in the wrong direction.	<p>Check that the antenna is pointed according to the position data.</p> <p>Adjust the position to the highest possible signal strength.</p>
Connection to the Internet cannot be established.	The signal strength is too low.	<p>Check that the antenna is pointed according to the position data.</p> <p>Adjust the position to the highest signal strength you can obtain.</p> <p>As a rule of thumb, you should have a signal strength of 45 dBHz or more to be able to make a call or data session.</p>
	Your connection is defined as a dial-up connection, but you have not opened the dial-up connection.	You need to open the dial-up connection before you can connect to the Internet.
	Your connection is a dial-up connection, but you have not entered the phone number *98# to indicate a connection to the Internet.	Change the phone number in the dial-up connection to *98# and open the dial-up connection before accessing the Internet.

Problem	Possible Cause	Remedy
The web interface cannot be accessed.	The browser is configured to use a proxy server.	For Microsoft Internet Explorer, select Tools > Internet Options > Connections > LAN Settings and uncheck Use a proxy server for your LAN .
	You have entered a wrong IP address.	Check the IP address and re-enter it.
	Your connection is defined as a dial-up connection, but you have not opened the dial-up connection.	You need to open the dial-up connection before you can connect to the Web server.
	Your connection is a dial-up connection, but you have not entered the phone number *98# or *99# to indicate connection to the Internet and/or the web interface.	Change the phone number in the dial-up connection to *98# or *99# and open the dial-up connection before accessing the web interface.
A Phone/Fax connection cannot be established.	The interface is disabled in the EXPLORER 500.	Enable the interface by entering the display menu system and selecting SETTINGS > INTERFACES > PHONE/FAX > ON , or by accessing the web interface and selecting SETTINGS > Phone/Fax > Enabled
	The cable is not properly connected.	Connect the cable.
	The cable type or connector type is not correct.	For information on the correct type of connector and cable, refer to <i>Phone/Fax interface</i> on page 158.
	Incoming calls: The voice quality used for the call is not selected in the web interface.	Make sure the voice quality used for calls to the EXPLORER 500 is selected in the web interface. Access the web interface and select SETTINGS > Phone/Fax . Then select the voice quality for incoming calls.

Problem	Possible Cause	Remedy
A Bluetooth handset connection cannot be established.	The interface is disabled in the EXPLORER 500.	Enable the interface by entering the display menu system and selecting SETTINGS > INTERFACES > BLUETOOTH > ON , or by accessing the web interface and selecting SETTINGS > Bluetooth > Enabled
	The Bluetooth handset is placed too far away from the EXPLORER 500.	Bring the handset closer to the EXPLORER 500. Note that the specified maximum distance is only valid under ideal conditions.
	The handset is not yet paired with the EXPLORER 500.	Pair the devices. Refer to <i>Pairing devices in which you can enter a passkey</i> on page 51.
	Incoming calls: The voice quality used for the call is not selected in the web interface.	Make sure the voice quality used for calls to the EXPLORER 500 is selected in the web interface. Access the web interface and select SETTINGS > Bluetooth . Under BLUETOOTH VOICE DEVICES locate the relevant handset and select the right voice quality for incoming calls.
A LAN connection cannot be established.	The interface is off in the EXPLORER 500.	Enable the interface by entering the display menu system and selecting SETTINGS > INTERFACES > LAN > ON , or by accessing the web interface and selecting SETTINGS > LAN > Enabled
	The cable is not properly connected.	Connect the cable.
	The cable type or connector type is not correct.	For information on the correct type of connector and cable, refer to <i>LAN interface</i> on page 159.

Problem	Possible Cause	Remedy
A USB connection cannot be established.	The cable is not properly connected.	Connect the cable.
	The cable type or connector type is not correct.	For information on the correct type of connector and cable, refer to <i>USB interface</i> on page 160.
	The dial-up connection is not created correctly.	Refer to <i>Creating a dial-up connection</i> on page 71.
	The Thrane & Thrane EXPLORER USB driver is not installed.	Install the driver as described in <i>First time setup of USB</i> on page 67.
	The USB connection uses a wrong COM port.	<p>Make sure the connection uses the COM port to which the Thrane & Thrane EXPLORER USB driver is assigned.</p> <p>In Windows XP, open your dial-up connection and select Properties. Under Connect using: check that the Thrane & Thrane EXPLORER USB driver is selected.</p> <p>If not, click Configure and select the Thrane & Thrane EXPLORER USB driver.</p>

Problem	Possible Cause	Remedy
A Bluetooth data connection cannot be established.	The interface is off in the EXPLORER 500.	Enable the interface by entering the display menu system and selecting SETTINGS > INTERFACES > BLUETOOTH > ON , or by accessing the web interface and selecting SETTINGS > Bluetooth > Enabled .
	The computer is placed too far away from the EXPLORER 500.	Bring the computer closer to the EXPLORER 500. Note that the specified maximum distance is only valid under ideal conditions.
	The computer is not yet paired with the EXPLORER 500.	Pair the devices. Refer to <i>Bluetooth pairing</i> on page 51.
	The requested Bluetooth profile is not supported, or is not activated on the computer.	Check the Bluetooth installation on your computer to see if the profile is supported and activated.
The Administrator password does not work.	Someone has changed the Administrator password.	If the correct password is not found, you have to reset the password. Contact your supplier for a reset code. You must provide the serial number and IMEI number of the terminal. Then enter the web interface and reset the password as described in: <i>Resetting the Administrator password</i> on page 126.

Status signaling

There are many ways of troubleshooting if an error occurs. The EXPLORER 500 has different means of status signaling, to help you find the cause of a problem:

- **Indicators.**
The function of the light indicators next to the display is described in *Light indicators* on page 8.
- **Alarm messages.**
- **Log files.**



Alarm messages and log files are described in the following sections.

Alarm messages

Display of alarm messages

The EXPLORER 500 can detect errors during POST (Power On Self Test) or CM (Continuous Monitoring). When the EXPLORER 500 detects an error that requires your action, it issues an alarm.

When alarms are issued in your EXPLORER 500, the display indicates the number of new alarms, and the red message indicator is flashing.

You now have the following options:

- Press **C** to ignore the alarm message and continue from where you were before the alarm was issued.
- Press **OK** to enter the alarm list showing all active alarms. The alarms are listed with their ID numbers. Unacknowledged alarms are marked **NEW**.
To acknowledge an alarm and see the name and time stamp, press **OK** again.
Use **▲** and **▼** to scroll through the name, ID and time stamp. If the text is too long, press **OK** (**▶**) to scroll through the rest of the text.



Once the alarm is acknowledged (OK) or C is pressed, the display returns to normal operation. The red message indicator keeps flashing as long as the cause of the alarm is still present.

Explanations for the alarms and remedies to solve the problems are listed in the next section.

All alarms are logged in the alarm log. For information on the alarm log, see *Alarm log* on page 154.

List of alarms

The following list explains the alarms that may show in the display and in the web interface of the EXPLORER 500.

Note

In the display and in the web interface the ID includes a hyphen followed by a control-digit at the end. This digit is used to make sure the ID is not misinterpreted when passed on, e.g. to service personnel. Make sure you include the entire number when contacting your distributor.

ID	Alarm Text	Explanation	Remedy
00100 to 00199	System Data Damaged	Important system data is damaged	Do not use the EXPLORER 500. Contact your distributor.
00200 to 00209	Battery Error	Error during communication with the battery	Only use the EXPLORER 500 with external power supply. Contact your distributor.
00210 to 00219	SIM Module Error	The SIM interface on the EXPLORER 500 cannot be used.	Contact your distributor.
00220 to 00229	USB Module Error	The USB interface on the EXPLORER 500 cannot be used.	Contact your distributor.
00230 to 00239	Temperature Sensor FATAL	The system is in danger of overheating.	Do not use the EXPLORER 500. Contact your distributor.
00240 to 00249	Temperature Sensor Error	Automatic adjustment of the display contrast does not work.	Contact your distributor.
00250 to 00259	Bluetooth Module Error	Bluetooth cannot be used.	Contact your distributor.
00260 to 00269	System Error	The EXPLORER 500 cannot communicate on the satellite network.	Contact your distributor.
00270 to 00279	Voice Module Error	Voice services cannot be accessed by the EXPLORER 500	Contact your distributor.

ID	Alarm Text	Explanation	Remedy
00280 to 00289	Ethernet Module Error	The Ethernet interface on the EXPLORER 500 cannot be used.	Contact your distributor.
00290 to 00299	Power Supply Error	Power on/off, charging and/or LED control may be out of function.	Contact your distributor.
00300 to 00309	GPS Module Error	The GPS module is out of function. The EXPLORER 500 cannot obtain a valid GPS position.	Contact your distributor.
01000 to 01009	Temperature Too Low	Low ambient temperature is causing the performance of the EXPLORER 500 to be degraded or halted.	Move the EXPLORER 500 to a warmer location. For information on temperature limits, see <i>General specifications</i> on page 155.
01100 to 01109	Data rate reduction due to high temperature	High ambient temperature is causing the performance of the EXPLORER 500 to be degraded or halted.	Move the EXPLORER 500 to a cooler location. For information on temperature limits, see <i>General specifications</i> on page 155.
01200 to 01209	Battery Level Low	The battery is running out of power.	Recharge the battery or replace it with a new one.
01300 to 01309	No GPS Fix	The GPS receiver has not yet achieved position fix.	Make sure the view to the GPS satellites is not blocked. To help the EXPLORER 500 obtain GPS fix, it should be placed flat on a surface pointing straight upwards, with a clear view to as much of the sky as possible. Note that in some cases it may take up to 10 minutes to obtain GPS fix.

ID	Alarm Text	Explanation	Remedy
01400 to 01409	Satellite Signal Lost	The EXPLORER 500 no longer receives a signal from the satellite.	Make sure the EXPLORER 500 has a clear view to the satellite. Check that the antenna is pointed according to the position data.
01500 to 01509	SIM Card Missing	No SIM card is detected in the SIM slot.	Insert SIM card. If the SIM card is already inserted, try removing and reinserting it.
01600 to 01609	SOS Calls Only	The SIM card is not accepted by the network. Only emergency calls are allowed.	Enter the PIN and wait for network approval. If the problem persists, contact your Airtime Provider.
01700 to 01709	Registration For Voice Failed	The EXPLORER 500 has not yet been allowed to register for voice services (Circuit Switched).	If the problem persists, contact your Airtime Provider.
01800 to 01809	Registration For Data Failed	The EXPLORER 500 has not yet been allowed register for data services (Packet Switched).	If the problem persists, contact your Airtime Provider.
01900 to 01909	Temperature Too Low For Charging	The temperature is too low for the battery charger to operate.	If charging is needed, move the EXPLORER 500 to a warmer location. The temperature must be above 0°C/+32°F for the battery charger to operate.
02000 to 02009	Satellite Signal Weak	The signal from the satellite is weak.	Check the line of sight to the satellite. Be aware that window glass may reduce the signal level. Check that the antenna is pointed according to the position data. Adjust the position to the highest possible signal strength.
02100 to 02109	Ciphering Off	The network has turned ciphering off.	Do not transmit data that requires ciphering.

ID	Alarm Text	Explanation	Remedy
02200 to 02209	Ethernet Connection Failed	Ethernet data session could not be established.	See the display call log for the cause of the error. Refer to <i>Calls menu</i> on page 39. If the problem persists, contact your distributor.
02400 to 02409	Invalid Battery	The EXPLORER 500 is not able to detect the battery type. The reason may be one of the following: <ul style="list-style-type: none"> • You are not using an original Thrane & Thrane battery • The battery is defective 	The EXPLORER 500 requires an original Thrane & Thrane battery. If you are already using an original Thrane & Thrane battery when you see this alarm, contact your distributor for support.
02600 to 02609	Antenna Failure	The EXPLORER 500 is not able to detect the state of the antenna relay.	Do not use the terminal. Contact your distributor.
02800 to 02809	Bluetooth Device Database Full	The list of paired Bluetooth devices is full. The EXPLORER 500 does not allow more than 7 paired devices.	Unpair a paired device to make room for a new one. For information on how to unpair devices, see <i>Unpairing devices</i> on page 109.
02810 to 02819	Bluetooth overload blocks power save	Too many Bluetooth devices are in sleep mode. Power save is blocked.	Unpair a device. The alarm may take a while to be cleared. If the alarm is not cleared, unpair one more device.
02900 to 02909	Network failed authentication	The EXPLORER 500 does not accept the network as a valid BGAN network.	Restart the EXPLORER 500. If the problem persists, contact your distributor.

Log files

Diagnostic report

When contacting Thrane & Thrane for support, please include a diagnostic report. The diagnostic report contains information relevant for the service personnel during troubleshooting.

To generate the diagnostic report, access the web interface and select **Help Desk**. Then click **Generate report**.

Alarm log

The alarm log holds information of all alarms issued by the EXPLORER 500.

The log includes the time of the error, a short description, location of the error etc. This information can help troubleshooting errors in the EXPLORER 500. The Alarm log is not accessible from the user interface, but is included when you generate a diagnostic report. For information, see *Help desk and diagnostic report* on page 136.

Call log

The call log holds information of up to 100 calls and data sessions to/from the EXPLORER 500.

The call log contains detailed information such as date, time, phone numbers, duration, Mb transferred etc., for each call or data session.

Date and time is UTC time, received from the satellite.

For information on how to view the call log in the display, see *Calls menu* on page 39.

For information on how to view the call log in the web interface, see *Viewing the lists of calls* on page 85.

Technical specifications

In this appendix

This appendix contains technical specifications for the EXPLORER 500 and information on Conformity.

General specifications

The EXPLORER 500 meets or exceeds current and proposed Inmarsat specifications for operation on the Inmarsat Broadband Global Area Network.

Item	Specification
Type	EXPLORER 500, BGAN Class 2 Terminal
Max. data rate ^a	
Downlink	464 kbps (shared)
Uplink	448 kbps (shared)
Streaming IP	32, 64, 128 kbps
Physical dimensions	218 mm x 216 mm x 52 mm/ 8.6" x 8.5" x 2.0"
Weight (including Battery)	1.4 kg/3.1 lbs
Environmental conditions	
Operating temperature	
Powered by external DC	-25°C to +55°C/-13°F to +131°F
Powered from battery	0°C to +55°C/+32°F to +131°F
Storage temperature	
Without battery	-40°C to +80°C/-40°F to +176°F
With battery	-20°C to +60°C/-4°F to +140°F
Relative humidity	95% non-condensing at +40°C/+104°F
Water & Dust	IP-54 (dust and spray proof in all directions)
Max. wind-load	18 m/s or 59 ft/s (Operational)
Robustness	0.5 m/1.64 ft drop on concrete (Operational, 95% survival)
Supported web browsers (Other browsers may be supported as well, but only these have been tested.)	Microsoft Internet Explorer 6.0 Mozilla Firefox 1.0 Apple Safari 2.0

a. Performance depends on a wide range of factors and actual usage.

Battery

Specifications

Item	Specification
Battery type	Lithium ion, rechargeable
Voltage	11.1 V
Capacity	2.2 Ah
Time between recharging	
Standby time ^a	36 hours
Standard call ^b	3 hours
Premium voice call ^b	1 hour 30 minutes
Download Streaming 128 kbps	3 hours 30 minutes
Upload Streaming 128 kbps	2 hours 15 minutes
Charge time ^a	Less than 3 hours (when the EXPLORER 500 is switched off)
Charge temperature	0°C to +45°C/+32°F to +113°F Ambient
Min. charge cycles	300
Storage temperature	
1 Month	-20°C to +60°C/-4°F to +140°F Ambient
3 Months	-20°C to +45°C/-4°F to +113°F Ambient
1 Year	-20°C to +20°C/-4°F to +68°F Ambient

a. Performance depends on a wide range of factors and actual usage.

b. With either Bluetooth or Phone interface.

Power input

Connector pin-out

This drawing shows the pin-out for the DC Power connector.

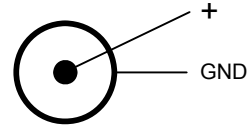

Specifications

Item	Specification
DC input range	+10 to +16 V DC
Power consumption ^a	
Standby mode	0.8 W (Typical)
Transmit mode	14 W (Typical)
During charging	38 W max.
Connector type	Proprietary DC Jack, 2.5 mm, positive center

a. Performance depends on a wide range of factors and actual usage.

AC/DC adapter, UP0501Q-15P

Item	Specification
AC input range	100 to 240 V AC, 47 to 63 Hz
DC output	15 V DC, 50 W

SIM interface

Specifications

Item	Specification
Slot type	Standard SIM card holder

Phone/Fax interface

Connector pin-out

The pin-out for the Phone/Fax connector is as follows:

Pin	Function
1	NC
2	Tip
3	Ring
4	NC

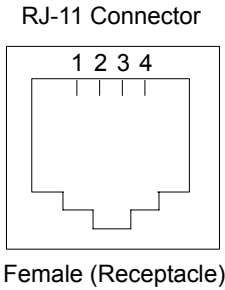

Specifications

Item	Specification
Connector type	RJ-11, female
Impedance	180 Ω + 750 Ω /150nF
Max. cable length	100 m/80 Ω
Max. units connected	One unit

LAN interface

Connector pin-out

The pin-out for the LAN connector is as follows:

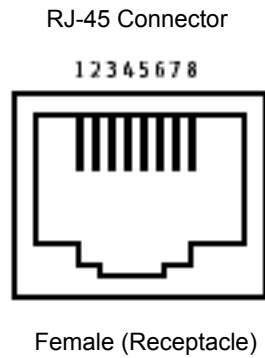

Pin	Function
1	Rx +
2	Rx -
3	Tx +
4	NC
5	NC
6	Tx -
7	NC
8	NC

Specifications

Item	Specification
Connector type	RJ-45, female, MDI-X (IEEE 802.3 10/100BaseT)
Standard	ISO/IEC 8877:1992 and IEEE 802.3 1998 Edition
Max. data rate	10/100 Mbps
Max. cable length	100 m/328 ft with Cat5 UTP

USB interface

Connector pin-out

The pin-out for the USB connector is as follows:

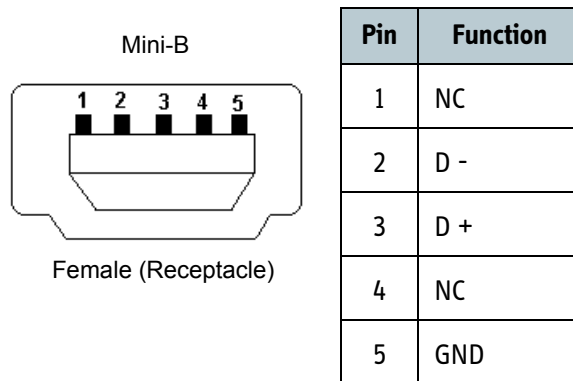

Specifications

Item	Specification
Version	1.1 (Slave)
Connector type	Mini-B, female
Max. data rate	12 Mbps
Max. cable length	5 m/16.4 ft
Max. units connected	7 physical devices
Driver	Proprietary, enclosed on CD with the product

Bluetooth interface

Specifications

Item	Specification
Version	1.2
Standard	Power Class 1. The Class 1 interface also supports Class 2 and Class 3 peripherals if they support RSSI (Received Signal Strength Indicator).
Antenna	Integrated in transceiver unit
Physical media	Frequency-Hopping Spread Spectrum RF
Max. data rate	721 kbps + 57.6 kbps
Frequency	2400 to 2483.5 MHz
Max. coverage outdoor ^a	100 m/328 ft
Max. number of devices connected	7
Profiles supported	Cordless Telephony Profile (CTP) Service Discovery Application Serial Port Profiles (SPP): <ul style="list-style-type: none"> • Dial-up Networking (DUN) • LAN Access Profile (LAP) • Headset Profile (HSP)

a. Performance depends on a wide range of factors and actual usage.

Built-in antenna

Specifications

Item	Specification
Type	Directional patch array, manually adjustable
Polarization	RHCP
Frequencies	
Inmarsat	
Transmit	1626.5 to 1660.5 MHz
Receive	1525.0 to 1559.0 MHz
Bearer bandwidth	200 kHz
GPS	1575.42 MHz
Bluetooth	2400.0 to 2483.5 MHz
EIRP	15.1 dBW \pm 1 dB
Power steps	0 to 10 dB in 1 dB steps

EXPLORER[®] Bluetooth Handset charger interface

Connector pin-out

This drawing shows the connector for the EXPLORER Bluetooth Handset charging interface.

The connector is placed at the back of the EXPLORER 500. Pin 1 is the pin closest to the coding projection on the plastic insert.

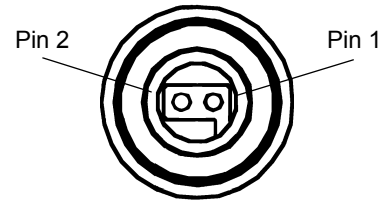

Specifications

Item	Specification
Connector type	Proprietary
Output	6.4 V/350 mA

Serial number label

The following label is placed on the EXPLORER 500.

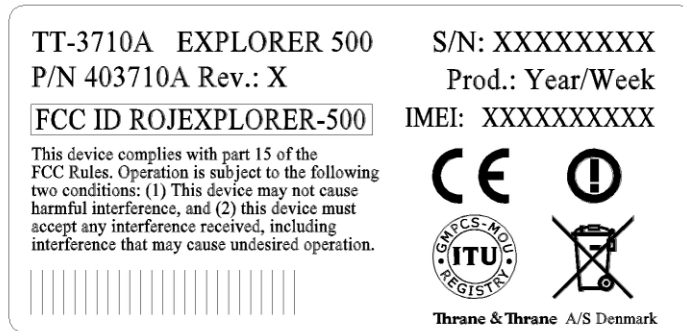

“Xes” are replaced by the relevant numbers for the specific terminal.

Conformity

CE (R&TTE)

The EXPLORER 500 is CE certified (R&TTE directive) as stated in “Declaration of Conformity with R&TTE Directive”, enclosed in electronic copy on the next page.

Use of Bluetooth:

Thrane & Thrane have sent notification to all countries in the EU for use of the Bluetooth interface. Individual license may be required in some countries outside the EU and USA.

For use in the EU, the following restrictions apply:

- France: Outdoor use must be limited to 10 mW EIRP within the frequency band 2454 MHz to 2483.5 MHz.
- Italy: Outdoor use outside own premises require general authorization.

FCC

This device complies with part 15 of the FCC Rules. Operation is subject to the following two conditions:

- 1) This device may not cause harmful interference, and
- 2) this device must accept any interference received, including interference that may cause undesired operation.

Part 15.21

Changes or modifications not expressly approved by the party responsible for compliance could void the user's authority to operate the equipment.

Note

The manufacturer is not responsible for any radio or TV interference caused by unauthorized modifications to this equipment. Such modifications could void the user's authority to operate the equipment.

GMPCS

The EXPLORER 500 has obtained the GMPCS-MoU mark.

Thrane & Thrane A/S

Declaration of Conformity with R&TTE Directive

The undersigned of this letter declares that the following equipment complies with the specifications of EC directive 1999/5/EC concerning Radio & Telecommunications Terminal Equipment.

Equipment included in this declaration

TT-3710A	EXPLORER™ 500	PN = 403710A
TT-3682L	AC/DC Adapter	PN = 403682L (UP0501Q-15P)

Equipment Applicability

The TT-3710A EXPLORER™ 500 is a mobile terminal that provides voice, fax or high-speed data communication through the Inmarsat satellite service world wide between a mobile terminal and any destination in the world. Only the Bluetooth interface of the terminal has restrictive use in France and Italy in EU. The Inmarsat interface to a satellite has no restriction in use. See User manual for further information.

Declaration

The safety requirement with respect to the LVD directive 73/23/EC is met by conforming to the harmonized EU standard EN 60950. The protection requirement with respect to the EMC directive 89/336/EC is met by conforming to the harmonized EU standards ETSI EN 301489-1, ETSI EN 301489-17 and ETSI EN 301489-20. Effective use of frequency spectrum is met by conforming to the harmonized EU standards ETSI EN 301444 and ETSI EN 300328.

Manufacturer

Thrane & Thrane A/S, Lundtoftegårdsvej 93D, DK-2800 Kgs. Lyngby, Denmark

Place and Date

Kgs. Lyngby, 11. May 2006

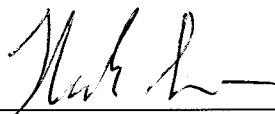

Henrik Lunde, CEO



Doc. no. 99-122652-D

Page: 1 of 1

AT commands

In this appendix

This appendix contains a list of AT Commands for the EXPLORER 500.

Starting up an AT command session

Set up your computer to use either the USB or Bluetooth interface. For further information, see *Using the USB interface* on page 67 or *Using a computer with Bluetooth* on page 70.

Connect your computer to the USB or Bluetooth interface of the EXPLORER 500 and launch your terminal program.

The following section contains a list of commands that can be used with the EXPLORER 500. For further information on the AT commands, refer to the following standards:

- **ITU V.250** Serial asynchronous automatic dialing and control
- **3GPP TS 27.005 ver. 4.2.0**, Use of Data Terminal Equipment - Data Circuit terminating Equipment (DTE-DCE) interface for Short Message Service (SMS) and Cell Broadcast Service (CBS)
- **3GPP TS 27.007 ver. 4.6.0**, AT command set for User Equipment (UE)

3GPP standards are found on www.3gpp.org

ITU standards are found on www.itu.int

List of supported AT commands

Command	Function
ATA	Answer
ATD	Dial
ATE	Command echo
ATH	Hang up
ATI	Request identification information
ATL	Monitor speaker loudness
ATM	Monitor speaker mode
ATN	Automode control
ATP	Select pulse dialing (command)
ATQ	Result code suppression
ATS	Set register
ATT	Select tone dialing (command)
ATV	DCE response format
ATX	Result code selection and call progress monitoring control
ATZ	Reset to default configuration
AT&C	Circuit 109 (Received line signal detector) behavior
AT&D	Circuit 108 (Data terminal ready) behavior
AT&F	Set to factory defined configuration
AT&V	Display active and stored profile
AT&W	Store profile
AT+CACM	Accumulated call meter
AT+CAEMLPP	eMLPP priority registration and interrogation
AT+CALM	Alert sound mode
AT+CAMM	Accumulated call meter
AT+CAOC	Advice of charge

Command	Function
AT+CBC	Battery charge
AT+CBST	Select bearer service type
AT+CCFC	Call forwarding number and conditions
AT+CCLK	Clock
AT+CCUG	Closed user group
AT+CCWA	Call waiting
AT+CCWE	Call meter maximum event
AT+CDIP	Called line identification presentation
AT+CEER	Extended error report
AT+CFCS	Fast call setup conditions
AT+CFUN	Set phone functionality
AT+CGACT	PDP context activate or deactivate
AT+CGATT	PS attach or detach
AT+CGCLASS	GPRS mobile station class
AT+CGCMOD	PDP context modify
AT+CGDATA	Enter data state
AT+CGDCONT	Define PDP context
AT+CGDSCONT	Define secondary PDP context
AT+CGEQMIN	3G quality of service profile (minimum acceptable)
AT+CGEQNEG	3G quality of service profile (negotiated)
AT+CGEQREQ	3G quality of service profile (requested)
AT+CGEREP	Packet domain event reporting
AT+CGMI	Request manufacturer identification
AT+CGMM	Request model identification
AT+CGMR	Request revision identification
AT+CGPADDR	Show PDP address

Command	Function
AT+CGQMIN	Quality of service profile (minimum acceptable)
AT+CGQREQ	Quality of service profile (requested)
AT+CGREG	GPRS network registration status
AT+CGSMS	Select service for MO SMS messages
AT+CGSN	Request product serial number identification
AT+CGTFT	Traffic flow template
AT+CHLD	Call related supplementary services
AT+CHUP	Hang-up call
AT+CIMI	Request International Mobile Subscriber Identity
AT+CIND	Indicator control
AT+CLAC	List all available AT commands
AT+CLCC	List current calls
AT+CLCK	Facility lock
AT+CLIP	Calling line identification presentation
AT+CLIR	Calling line identification restriction
AT+CMAR	Master reset
AT+CMEC	Mobile equipment control mode
AT+CMEE	Report mobile equipment error
AT+CMER	Mobile equipment event reporting
AT+CMGC	Send command
AT+CMGD	Delete message
AT+CMGF	Message format
AT+CMGL	List messages
AT+CMGR	Read messages
AT+CMGS	Send message
AT+CMGW	Write message to memory

Command	Function
AT+CMOD	Call mode
AT+CMSS	Send message from storage
AT+CNMI	New message indication to TE
AT+CNUM	Subscriber number
AT+COLP	Connected line identification presentation
AT+COPN	Read operator names
AT+COPS	PLMN selection
AT+CPAS	Phone activity status
AT+CPBF	Find phone book entries
AT+CPBR	Read phone book entries
AT+CPBS	Select phone book memory storage
AT+CPBW	Write phone book entry
AT+CPIN	Enter PIN
AT+CPLS	Selection of preferred PLMN list
AT+CPMS	Preferred message storage
AT+CPOL	Preferred PLMN list
AT+CPPS	eMLPP subscriptions
AT+CPUC	Price per unit and currency table
AT+CPWD	Change password
AT+CR	Service reporting control
AT+CRC	Cellular result codes
AT+CREG	Network registration
AT+CRSM	Restricted SIM Access
AT+CSCA	Service center address
AT+CSCS	Select TE character set
AT+CSDF	Settings date format

Command	Function
AT+CSIL	Silence command
AT+CSMS	Select message service
AT+CSQ	Signal quality
AT+CSSN	Supplementary service notifications
AT+CSTA	Select type of address
AT+CSTF	Settings time format
AT+CSVM	Set voice mail number
AT+CUSD	Unstructured supplementary service data
AT+CAAP	Automatic answer for eMLPP Service
AT+FCLASS	Select mode
AT+GCAP	Request complete capabilities list
AT+GCI	Country of Installation
AT+GMI	Request manufacturer identification
AT+GMM	Request model identification
AT+GMR	Request revision identification
AT+GSN	Request product serial number identification
AT+ICF	DTE DCE character framing
AT+IFC	DTE-DCE local flow control
AT+ILRR	DTE-DCE local rate reporting
AT+IPR	Fixed DTE rate
AT+WS46	PCCA STD-101 [17] select wireless network
AT_IBLTH	Bluetooth management
AT_IBNOTIFY	Control the sending of unsolicited result codes
AT_IBTIF	Bluetooth configuration
AT_IBTINQ	Bluetooth inquiry management
AT_IGPS	GPS location information

Command	Function
AT_ILOG	Retrieve log file from the EXPLORER 500
AT_IMETER	Call metering
AT_INIS	Network interface status
AT_IPOINT	Antenna pointing
AT_ISIG	Signal quality indication
AT_ITCSI	Configure incoming voice quality
AT_ITCSO	Configure outgoing voice quality
AT_ITEMP	Temperature in the EXPLORER 500
AT_ITNAT	Configure NAT for an interface

A

APN Access Point Name. The Access Point Name is used by the EXPLORER 500 user to establish the connection to the required destination network.

B

BGAN Broadband Global Area Network. A satellite network based on geostationary satellites, delivering data rates of up to 492 kbps to virtually any part of the earth, with full UMTS (3G) compatibility.

C

CE Conformité Européenne. This term signifies that a CE certified product conforms to European health, environmental, and safety regulations. In short, it makes the product legal to be sold in the European Union.

CID Context Identifier

D

DHCP Dynamic Host Configuration Protocol. A protocol for assigning dynamic IP addresses to devices on a network. With dynamic addressing, a device can have a different IP address every time it connects to the network.

F

FCC Federal Communications Commission. An independent United States government agency, directly responsible to Congress. FCC certification is normally required to make a product legal to be sold in the United States.

G

Geostationary Placed in a fixed position relative to a point on the surface of the earth.

GMPCS Global Mobile Personal Communications by Satellite. GMPCS is a personal communication system providing transnational, regional or global coverage from satellites.

GMPCS-MoU	A framework signed by Member States, GMPCS System Operators, Terminal Manufacturers and Service Providers. The GMPCS-MoU mark allows GMPCS subscribers to take terminals anywhere and use them in countries where they are licensed.
GPRS	General Packet Radio Service. A standard for wireless communications which runs at speeds up to 115 kbps, compared with current GSM (Global System for Mobile Communications) systems' 9.6 kbps.
GPS	Global Positioning System. A system of satellites, computers, and receivers that is able to determine the latitude and longitude of a receiver on Earth by calculating the time difference for signals from different satellites to reach the receiver.

I

IMEI	International Mobile Equipment Identity. A unique number given to every single piece of mobile phone equipment. IMEI numbers are stored in a database containing all valid mobile phone equipment.
IMSO	International Maritime Satellite Organisation. An intergovernmental body established to ensure that Inmarsat continues to meet its public service obligations, including obligations relating to the GMDSS.
ISDN	Integrated Services Digital Network. An international communications standard for sending voice, video, and data over digital telephone lines or normal telephone wires. ISDN supports data transfer rates of 64 kbps.
ISP	Internet Service Provider

K

kbps	kilobits per second
------	---------------------

L

LAN	Local Area Network. A system that links together electronic office equipment such as computers and word processors, and forms a network within an office or building.
LaunchPad	LaunchPad is a PC application used to control terminals in the BGAN system. LaunchPad is provided on the Inmarsat CD-ROM supplied with your EXPLORER 500. Use of the LaunchPad is described in the user guide on the CD-ROM.

M

MAC	Media Access Control address. A hardware address that uniquely identifies each node of a
-----	--

network.

MDI-X Medium Dependent Interface. An MDI-X (for MDI crossover) is a version of MDI that enables connection between like devices. MDI ports connect to MDI-X ports via straight-through cabling. MDI-to-MDI and MDIX-to-MDIX connections use crossover cabling.

N

NAT Network Address Translation. An Internet standard that enables a local-area network to use one set of IP addresses for internal traffic and a second set of addresses for external traffic. A NAT module makes all necessary address translations.

NC Not Connected

P

Pairing Bluetooth Pairing happens when two Bluetooth enabled devices agree to communicate. The two devices exchange passkeys and join what is called a trusted pair. In a trusted pair, the two devices automatically accept communication with each other.

Passkey A unique code or password used when pairing Bluetooth devices.

PCB Printed Circuit Board

PDA Personal Digital Assistant. A lightweight, hand-held, usually pen-based computer used as a personal organizer.

PDP Packet Data Protocol. A network protocol used by external packet data networks that communicate with a GPRS network.

PIN Personal Identification Number. A code number used to provide access to a system that has restricted access.

PUK PIN Unlocking Key. An eight-digit code used to unblock a SIM card after three incorrect PINs have been entered. The PUK code is supplied with the SIM card.

R

RDI Restricted Digital Information

RSSI Received Signal Strength Indicator

S

- SAS** Satellite Access Station. The gateway between the satellites and the worldwide networks such as Internet, telephone network, cellular network etc.
- SDU** Service Data Unit. Also known as a data packet.
- SIM** Subscriber Identity Module. The SIM provides secure storing of the key identifying a mobile phone service subscriber but also subscription information, preferences and storage of text messages.
- Streaming** A technique for transferring data - such as audio or video clips - so that it is processed as a continuous stream. With a Streaming connection you are charged by the minute, like for a telephone connection.

T

- TFT** Traffic Flow Template. A packet filter list allowing the Core network and the EXPLORER 500 to classify packets received from the external network into the proper PDP context.

U

- UDI** Unrestricted Digital Information. A transparent 64 kbps data channel.
- USB** Universal Serial Bus. An interface standard for communication between a computer and external peripherals over an inexpensive cable using biserial transmission. Mostly used with keyboards, mice, monitors and printers.

V

- VPN** Virtual Private Network. A network that is constructed by using public wires to connect nodes. You can create networks using the Internet for transporting data, using security mechanisms so that only authorized users can access the network.

Numerics

- 2-wire interface
 - connecting, 54
 - selecting voice quality, 110
 - specifications, 158
- 64 kbps UDI using USB, 69

A

- access rights in web interface
 - setting up, 135
- accessories available, 141
- administration settings, 125
- advanced configuration
 - Bluetooth, 104
 - LAN, 99
 - network settings, 117
 - USB, 97
- alarms
 - in display, 46, 149
 - list of active, 45, 124
- antenna
 - for Bluetooth, 161
 - pointing, 24
 - repointing, 40, 81
 - specifications, 162
- APN
 - setting for all interfaces, 117
 - setting for Bluetooth, 105
 - setting for LAN, 99
 - setting for USB, 97
- applications overview, 6
- AT commands, 167
- audio indicators, 41, 94
- audio quality, 52
- automatic power up, 42, 93
- Azimuth, 21

B

- backlight in display, 40, 93
- barring calls, 113

- battery
 - charging, 139
 - dummy, 141
 - guidelines for use, 139
 - inserting, 12
 - removing, 13
 - specifications, 156
- BGAN
 - coverage, 2
 - services, 4
 - system overview, 3
- Bluetooth devices
 - pairing, 51, 107
 - unpairing, 109
 - viewing list of paired, 109
- Bluetooth handset
 - charging interface, 73, 163
 - connecting, 55
 - making a call, 57
- Bluetooth interface
 - connecting a computer, 70
 - connecting a handset, 55
 - setting up, 104
 - setting voice quality, 104
 - specifications, 161
- browser settings
 - for web interface, 75

C

- call log, 39, 92
- call type, 52
- calls
 - barring, 113
 - closed user group, 116
 - forwarding, 112
 - holding, 61
 - line identification, 115
 - local, 60
 - making or receiving, 57
 - missed, received, outgoing, 39, 85
 - redial, 59
 - to the EXPLORER 500, 58
 - view ongoing, 80
 - waiting indication, 60, 114
- CE compliance, 165
- certification, 165

- clearing logs, 129
- clearing usage counter, 129
- closed user group, 116
- common network settings, 117
- compliance, 165
- configuration
 - Bluetooth, 104
 - exporting to file, 128
 - import from file, 128
 - LAN, 99
 - USB, 97
- conformity, 165
- connectors
 - Bluetooth handset charging, 163
 - LAN, 159
 - overview, 15
 - Phone/Fax, 158
 - Power, 157
 - USB, 160
- contact information, 138
- contrast in display, 40, 93
- coverage
 - Inmarsat BGAN system, 2

D

- dashboard, 79
- data
 - advanced configuration, 117
 - Profiles, 130
 - Traffic Flow Templates, 133
- data sessions
 - view ongoing, 80
- delivery
 - items included, 11
- DHCP
 - enable or disable for LAN, 99
- display
 - backlight, 40, 93
 - contrast, 40, 93
 - menu drawing, 32
 - navigating, 35
 - overview of menus, 31
 - short-cuts, 35
 - symbols, 34
- disposal, 140
- distributors, 138
- dummy battery, 141

E

- Elevation, 21
- Ethernet interface
 - connecting, 65
 - setting up, 99
 - specifications, 159
- EXPLORER 500
 - getting to know, 7
 - type number, ii
- export configuration, 128

F

- fax
 - sending or receiving, 62
- FCC compliance, 165
- features, 5
- forwarding calls, 112

G

- general specifications, 155
- GMPCS compliance, 165
- GPS
 - antenna, 9
 - frequency, 162
 - obtaining GPS fix, 23
 - position, 43
 - troubleshooting, 144
 - view status, 43

H

- hardware
 - view version, 79, 120
- Header compression
 - enable or disable for Bluetooth, 105
 - enable or disable for LAN, 99
- help desk number, 45, 136
 - changing with web interface, 136

I

- IMEI number, 44, 79, 120
- import configuration, 128
- Inbox for SMS messages
 - replying, forwarding or deleting, 89

indicators
 function, 8
 interfaces
 turning on or off, 41, 50
 interfaces and services
 combinations, 10
 internal calls, 60
 IP address, 44, 79, 120
 ISDN using USB, 69
 items included in delivery, 11

L

LAN interface
 connecting, 65
 setting up, 99
 specifications, 159
 language
 selecting, 42, 119
 LaunchPad, 48
 LEDs
 function, 8
 light and sound
 disabling, 41, 94
 light indicators
 function, 8
 line identification, 115
 local phone call, 60
 logs
 clearing, 129

M

MAC address, 44, 79, 120
 matrix of services and interfaces, 10
 messages
 configuring outgoing, 90
 deleting in display, 37
 forwarding, 89
 opening in display, 37
 opening in web interface, 89
 receiving in display, 46
 receiving in web interface, 88
 replying, 89
 sending, 88
 view list in display, 37

N

NAT
 setting for LAN, 99
 navigation
 display and keypad, 35
 web interface, 77
 number of EXPLORER 500 terminal, ii

O

off-line
 working with EXPLORER 500, 19
 options available, 141
 Outbox for SMS messages
 resending or deleting messages, 87

P

paired Bluetooth devices
 view list, 109
 pairing Bluetooth devices, 51, 107
 phone
 local call, 60
 making calls, 57
 phone book, 82
 add number, 83
 delete all entries, 83
 delete entry, 83
 modify entry, 83
 Phone/Fax interface
 connecting, 54
 selecting voice quality, 110
 specifications, 158
 PIN
 administration PIN, 125
 entering in display, 20
 entering in web interface, 78
 entering with a phone, 56
 pointing, 24
 help, 21
 position data, 21
 repoint the antenna, 40
 sound on/off, 41, 94
 pole mount, 26
 port forwarding, 102
 POTS interface
 connecting, 54
 selecting voice quality, 110
 specifications, 158

- power, 17
 - automatic, 42, 93
 - connecting, 16
 - specifications, 157
 - power up mode, 42, 93
 - Profiles
 - for data transmission, 130
 - selecting for Bluetooth, 105
 - selecting for LAN, 99
 - selecting for USB, 97
 - properties
 - view, 44, 79, 120
 - Proxy server
 - disabling, 75
 - PUK code, 21, 56, 78
- Q**
- quality of voice, 52
 - Quick dial, 57
- R**
- redial, 59
 - restoring settings, 42
- S**
- safety summary, iii
 - semi-fixed installation, 26
 - sent messages
 - resending, forwarding or deleting, 87
 - viewing status, 87
 - serial number, 44, 79, 120
 - services
 - supplementary, 111
 - supported by BGAN, 4
 - services and interfaces
 - combinations, 10
 - settings
 - restore, 42
 - Short dial, 57
 - show number, 115
 - SIM card
 - inserting, 12
 - removing, 14
 - specifications, 157
 - SIM lock, 10
 - SMS in display
 - opening or deleting, 37
 - receiving, 46
 - view list, 37
 - SMS in web interface
 - forwarding, 89
 - opening, 89
 - receiving, 88
 - replying to, 89
 - sending, 88
 - SMS service number, 79, 91, 120
 - software
 - uploading, 121
 - view version, 79, 120
 - sound
 - alarm, 41, 94
 - message, 41, 94
 - when pointing, 41, 94
 - sound and light
 - disabling, 41, 94
 - specifications
 - antenna, 162
 - Bluetooth handset charging interface, 163
 - Bluetooth interface, 161
 - Ethernet interface, 159
 - general, 155
 - LAN interface, 159
 - Phone/Fax interface, 158
 - Power, 157
 - SIM card, 157
 - USB interface, 160
 - Standard data, 64
 - activating, 38, 80
 - automatic activation, 101
 - start-up
 - options, 18
 - status
 - methods for signaling, 149
 - viewing, 47, 79
 - stealth mode
 - activating, 35
 - enabling, 41, 94
 - Streaming data, 64
 - activating, 38, 64
 - defining Profiles for, 130
 - supplementary services
 - setting up, 111
 - supported, 4
 - using, 60
 - support
 - contact information, 138

T

- telephone interface
 - connecting, 54
 - setting voice quality, 110
 - specifications, 158
- total usage
 - viewing, 80, 84
- Traffic Flow Templates, 133
- troubleshooting guide, 142
- type number of EXPLORER 500 terminal, ii

U

- UDI using USB, 69
- unpairing Bluetooth devices, 109
- uploading software, 121
- usage counter, 80, 84
 - clearing, 129
- USB interface
 - connecting, 67
 - setting up, 97
 - specifications, 160
- user permissions in web interface
 - setting up, 135

V

- version
 - hardware, 44, 79, 120
 - software, 44, 79, 120
- voice mail number
 - viewing, 44, 91
- voice quality, 52
 - selecting for Phone/Fax interface, 110
 - setting for Bluetooth, 104

W

- waiting calls, 114
- web interface
 - accessing, 74
 - browser settings, 75
 - definition, 74
 - navigating, 77