

User & Installation Manual

LT-3100 Satellite Communications System

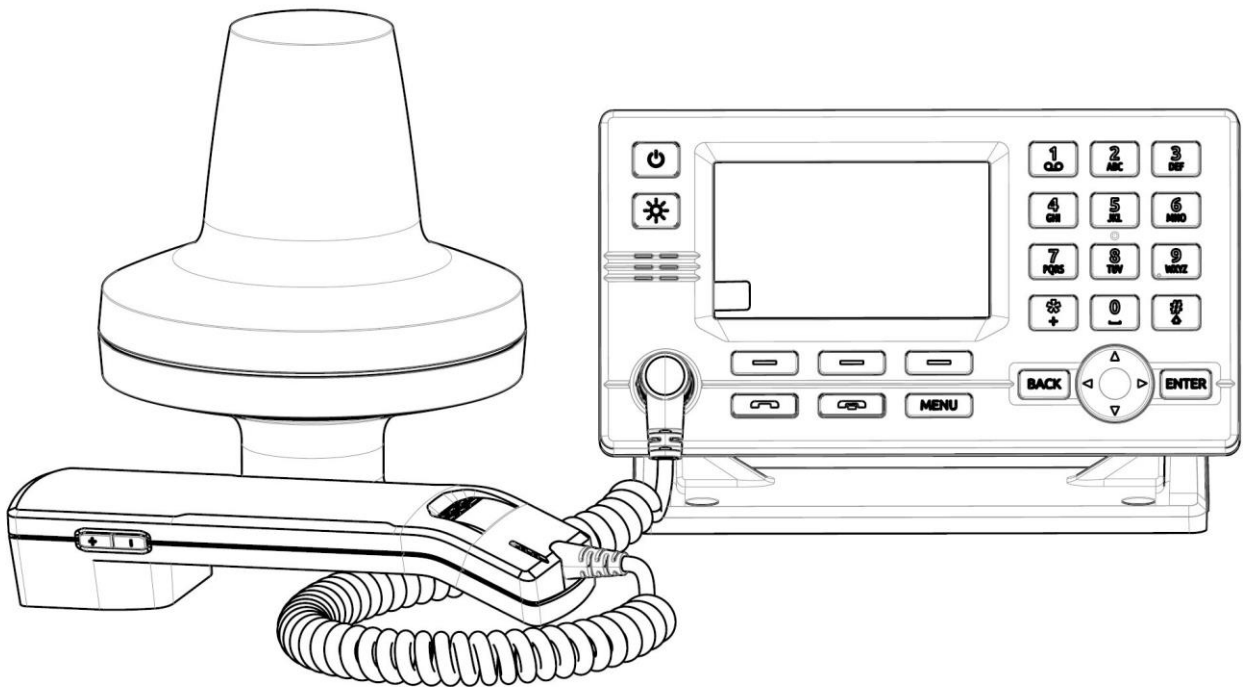

Document Number: 95-100765 Rev 1.06

Release date: January 2022

Copyright © Lars Thrane A/S

Denmark

ALL RIGHTS RESERVED

This Document is of © copyright to Lars Thrane A/S. It contains proprietary information, which is disclosed for information purposes only. The contents of this document shall not in whole or in part be used for any other purpose without prior permission from Lars Thrane A/S.

Disclaimer

Any responsibility or liability for loss or damage in connection with the use of this product and the accompanying documentation is disclaimed by Lars Thrane A/S. The information in this manual is provided for information purposes only, is subject to change without notice, and may contain errors or inaccuracies. Manuals issued by Lars Thrane A/S are periodically revised and updated. Anyone relying on this information should acquire the most current version e.g. from Lars Thrane A/S. Lars Thrane A/S is not responsible for the content or accuracy of any translations or reproductions, in whole or in part, of this manual from any other source.

Copyright

© 2022 Lars Thrane A/S. All rights reserved.

Disposal

Old electrical and electronic equipment marked with this symbol can contain substances hazardous to human beings and the environment. Never dispose these items together with unsorted municipal waste (household waste). In order to protect the environment and ensure the correct recycling of old equipment as well as the re-utilization of individual components, use either public collection or private collection by the local distributor of old electrical and electronic equipment marked with this symbol. Contact the local distributor or dealer for information about what type of return system to use.



IMO and SOLAS

The equipment described in this manual is intended for use on commercial marine and leisure vessels. The equipment is not covered by the International Maritime Organization (IMO) and Safety of Life at Sea (SOLAS) regulations.

Safety Instructions for Installer & Operator

The following safety instructions must be observed during all phases of operation, installation, service and repair of this equipment. Failure to comply with these precautions or with specific warnings elsewhere in this manual violates safety standards of design, manufacture and intended use of the equipment.

Lars Thrane A/S assumes no liability for the customer's failure to comply with these requirements.

Instructions for the Installer

WARNING - Product installation

To ensure correct performance of this equipment, it is strongly recommended that professionals with expertise, properly trained, and likewise authorized within the industry is completing the installation.

WARNING – Turn off power switch

Turn off the main power switch before installing the equipment described in this manual. Do not connect or disconnect equipment when the main power switch is on.

WARNING – Use only the supplied cable

Use only the supplied power and communication cable for connecting the equipment.

WARNING – Input Power

The input voltage range is: 12-24 VDC.

WARNING – Power supply protection

Make sure that the power supply is adequately protected by a fuse or an automatic circuit breaker when installing the equipment (max. 7.5 A).

WARNING - Explosive atmosphere

Do not operate the equipment in the presence of flammable gases or fumes. Operation of any electrical equipment in such an environment constitutes a definite hazard.

WARNING - Compass safe distance

The compass safe distance for standard and steering compasses is 1.40 m (4.6 ft) and 0.90 m (3.0 ft) respectively. Observe these distances to prevent interference to a magnetic compass.

Instructions for the Operator

WARNING – Do not disassemble

Do not disassemble or modify this equipment. Fire, electrical shock, or serious injury can result.

WARNING – Keep away from live circuits

Operational personnel must not remove product enclosure. Do not service the equipment with the communication cable connected. Always disconnect and discharge unit, cable and circuits before touching them.

WARNING - Permanent watch

In case of smoke or water leaks into the equipment, immediately turn off the power. Continued use of the equipment can cause fire or electrical shock. Keep access and permanent watch of the equipment in order to prevent any unwanted escalation.

WARNING – DC mains connector

The DC mains connector is to be used as the disconnection device to isolate the equipment from the mains supply.

IMPORTANT - Safety distance

The safety distance from the LT-3130 Antenna Unit, when the LT-3130 Antenna Unit is powered and transmitting, is 0.1 m (0.3 ft), to comply with the regional regulations.

Always keep this safety distance to the LT-3130 Antenna Unit to avoid any serious injury.

If the safety precautions and warnings on this site are not followed, warranty will be void.

**IMPORTANT – FCC Compliance Note:**

This equipment has been tested and found to comply with the limits for a Class B digital device, pursuant to part 15 of the FCC Rules. These limits are designed to provide reasonable protection against harmful interference in a residential installation. This equipment generates, uses and can radiate radio frequency energy and, if not installed and used in accordance with the instructions, may cause harmful interference to radio communications. However, there is no guarantee that interference will not occur in a particular installation. If this equipment does cause harmful interference to radio or television reception, which can be determined by turning the equipment off and on, the user is encouraged to try to correct the interference by one of the following measures:

- Reorient or relocate the receiving antenna.
- Increase the separation between the equipment and the receiver.
- Connect the equipment into an outlet on a circuit different from that to which the receiver is connected.
- Consult the dealer or an experienced radio/TV technician for help.

This product does not contain any user-serviceable parts.

Repairs should only be made by an authorized Lars Thrane A/S service center. Unauthorized repairs or modifications could result in permanent damage to the equipment and void your warranty and your authority to operate this device under Part 15 regulations.

**IMPORTANT – Innovation, Science and Economic Development Canada Compliance Note:**

This device complies with Innovation, Science and Economic Development Canada license-exempt RSS standard(s). Operation is subject to the following two conditions: (1) this device may not cause interference, and (2) this device must accept any interference, including interference that may cause undesired operation of the device.

Required information for the reader

Throughout this document, essential information will be presented to the reader. The following text (emphasized) has the following meaning and/or implication:

WARNING: A 'Warning' is an Operation or Service procedure that, if not avoided, may cause a hazard situation, which could result in personnel death or serious injury.

IMPORTANT: Text marked 'Important' provides essential information to the reader and is key information to the user for the equipment to work properly. Damage to the equipment can occur if instructions are not followed.

NOTE: A 'Note' provides essential information to the reader.

About this manual

Intended readers

This is a User & Installation Manual for LT-3100 Satellite Communications System, or LT-3100 system. The manual is primarily intended for installers and service personnel.

Personnel installing or servicing the system should be professionals with technical expertise, properly trained, and likewise authorized.

All safety instructions and guidelines in this manual must be observed. The safety instructions are listed in the beginning of the manual. The guidelines are to be found in the separate chapters, where it is needed.

Software versions

This manual is applicable to the following software:

Software Versions		
Description	P/N	Version
LT-3100 system	71-101301	1.13R

Table 1: Software Versions

IMPORTANT: The latest software released by Lars Thrane A/S must always be used for new installations of the LT-3100 System and should be updated to ensure the best possible performance of the system and services.

NOTE: The latest LT-3100 Software and Release Notes can always be downloaded from the Lars Thrane A/S website. Please contact Lars Thrane A/S for details about future software releases and features.

Record of Revisions

Rev.	Description	Release Date	Initials
1.00	Original document.	January 12, 2018	PT
1.01	Editorial corrections.	January 17, 2018	PT
1.02	As a result of the certification completed, the following sections are updated: Safety Instructions for Installer & Operator App. A - Specifications	May 29, 2018	PT
1.03	As a result of the certification process, the following sections are updated: Safety Instructions for Installer & Operator	July 13, 2018	CT
1.04	As a result of the FCC certification process, the following sections are updated: Safety Instructions for Installer & Operator	November 5, 2018	CT
1.05	As a result of the RED certification process, the following sections are updated: Frequencies band utilized (App. A) Maximum RF output powers for Iridium & BT transmitters (App. A) EU Declaration of Conformity (App. J)	March 12, 2019	CT
1.06	Updated and added several chapters (incl.): Tracking Bridge Alert Management (BAM) Data (Modem Data, SMS, and SBD) Bluetooth NMEA 0183 GNSS over UDP (broadcast on LAN or Bluetooth) Web Server User login External SIP Phones Web Server Contacts	January, 2022	KTL

Table of Contents

Introduction	1
Application and Limitations	2
Unpacking (in-the-box)	3
Inspection	3
Accessories	4
Mounts	4
Cable and connectors	4
System Overview	5
Installation and Mounting	6
LT-3110 Control Unit	6
LT-3120 Handset	9
LT-3121 Cradle	10
LT-3130 Antenna Unit	11
Bracket Mount (1.5" to 2.5" pipe), Antenna Unit	19
Pole Mount (1.5" pipe, 38.8 mm), Antenna Unit	23
Pole Mount (2.0" pipe, 53.0 mm), Antenna Unit	25
Interfaces	27
LT-3110 Control Unit	27
LT-3130 Antenna Unit	36
Power Consumption	38
Maximum	38
DC Isolation Resistance and Chassis Ground	39
Galvanic Isolated Power Supply	41
AC/DC Galvanic Isolated Power Supply	41
DC/DC Galvanic Isolated Power Supply	41
User Interface (UI)	42
Display	43
Menu System	47
Activating the System	49
Acquire a SIM Card	50
Who's My Service Provider	51
Change of Hardware and Software	52
Change of Hardware	52

Software Update.....	53
System Services.....	54
Voice call	54
SMS.....	60
External SIP Phones	65
Analogue Phone Adapter.....	67
Data (Modem Data, SMS and SBD).....	68
Tracking.....	71
Bluetooth	74
System Submenus.....	77
Phone	77
Settings.....	81
System	88
Bridge Alert Management (BAM).....	93
Serial Interface (RS-422)	97
GNSS sentences.....	97
BAM sentences	98
NMEA 0183 over UDP	99
Web server	100
Accessing the built-in web server.....	101
Dashboard.....	102
Messages.....	103
Configuration	105
Maintenance	129
Legal notice	131
Log out.....	131
Disable login timeout.....	131
Service & Repair.....	132
Appendixes.....	133
App. A - Applicable Standards	133
App. B - Bridge Alert Management (BAM).....	134
App. C - Multiple talkers and multiple listeners	137
App. D - GNSS sentences	138
App. E - BAM Sentences.....	139

App. F - GNSS Receiver Integrity States	140
App. G - Specifications	145
App. H - Outline Drawing: LT-3110 Control Unit.....	146
App. I - Outline Drawing: Bracket Mount, Control Unit	147
App. J - Outline Drawing: Flush Mount, Control Unit.....	148
App. K - Outline Drawing: LT-3130 Antenna Unit	149
App. L - Outline Drawing: Pole Mount (1.5" pipe, 38.8mm), Antenna Unit	150
App. M - Outline Drawing: Pole Mount (2.0" pipe, 53.0 mm), Antenna Unit	151
App. N - Outline Drawing: Bracket Mount, Antenna Unit.....	152
App. O - Outline Drawing: LT-3120 Handset.....	153
App. P - Outline Drawing: LT-3121 Cradle.....	154
App. Q - EU Declaration of Conformity	155

Introduction

Congratulations on your purchase of the LT-3100 Satellite Communications system!

The LT-3100 Satellite Communications System is a maritime satellite communication product from Lars Thrane A/S. The LT-3100 system is designed for the professional market (deep sea, fishing, and workboats), but can be used for the leisure market as well. The LT-3100 system meets all standards and certification requirements needed for worldwide maritime satellite communication equipment.

The LT-3100 system has voice and data capabilities with 100% global coverage provided by the Iridium® Communications Network.

The LT-3100 system consists of a control unit, antenna unit, handset and cradle.

A single coaxial cable connects the control unit with the antenna unit. Using a standard coaxial cable, up to 500 meters of separation between the units can be obtained, giving freedom to mount the antenna unit in the best possible location, with free line of sight to the Iridium satellites.

The LT-3100 system can be used as the primary satellite communication product on vessels, covering the basic communication needs in terms of connectivity between the ship and shore and ship to ship.

Application and Limitations

- The LT-3100 system shall be installed according to manufacturer's User & Installation Manual.
- The LT-3100 system includes an integrated Global Navigation Satellite System (GNSS) receiver for position fixing.
- The LT-3130 Antenna Unit operational low temperature is:
 - -30°C (-22°F) when using 12 VDC input power on the LT-3110 Control Unit
 - -40°C (-40°F) when using 24 VDC input power on the LT-3110 Control Unit

Unpacking (in-the-box)

Unpack the LT-3100 Satellite Communications System – Basic (P/N: 90-101142) and check that the following items are present in the box:

- 51-100987 LT-3110 Control Unit
- 51-100988 LT-3120 Handset
- 51-101181 LT-3121 Cradle
- 51-100989 LT-3130 Antenna Unit
- 91-100771 Bracket Mount, Control Unit
- 91-102118 Power Cable, 3m
- 4 x Stainless steel A4 screws (for Bracket Mount, Control Unit)
- 2 x Stainless steel A4 screws (for Cradle)
- 4 x Unit Test Sheets
- 95-100765 LT-3100 User & Installation Manual

NOTE: Antenna unit mounts (bracket and pole mount) are not included in the LT-3100 Satellite Communications System - Basic (P/N: 90-101142) and must be ordered separately. The antenna unit must only be mounted, using the bracket or pole mount, delivered by Lars Thrane A/S. The antenna unit mounts are listed with part numbers (P/N) in *Accessories* on page 4.

Inspection

Inspect the shipping cartons and/or wooden box immediately upon receipt for evidence of damage during transport. If the shipping material is severely damaged or water stained, request that the carrier's agent is present when opening the cartons and/or wooden box. Save all box packing material for future use.

After unpacking the system and opening the cartons, inspect it thoroughly for hidden damage and loose components or fittings. If the contents are incomplete, if there is mechanical damage or defect, or if the system does not work properly, notify your distributor.

WARNING: To avoid electric shock, do not apply power to the LT-3100 system components if there is any sign of shipping damage to any part of a unit or the outer cover. Read the Safety Instructions at the front of this manual before installing or operating the system.

Accessories

Mounts

The following accessory parts are not part of the basic system and must be ordered separately:

- 91-100772 Flush Mount, Control Unit
- 91-100774 Pole Mount (1.5" pipe, 38.8mm), Antenna Unit
- 91-102520 Pole Mount (2.0" pipe, 53.0 mm), Antenna Unit
- 91-102469 Bracket Mount (1.5" to 2.5" pipe), Antenna Unit with Cable Hose (*discontinued*)
- 91-102470 Cable Hose (standalone)

In order to avoid corrosion when using the Bracket Mount (1.5" to 2.5" pipe), we have introduced a Cable Hose for the antenna unit, which is recommended to use for all installations using this mount. The Cable Hose is illustrated in Figure 23 on page 22.

Cable and connectors

The following cable and connector parts are not part of the basic system and must be ordered separately:

- 91-100768 Aux Cable, 3m
- 91-101183 Coaxial cable Ø4.9mm, 10m
- 91-101184 Coaxial cable Ø4.9mm, 25m
- 91-101137 Coaxial Cable Ø10.3mm 10m
- 91-101138 Coaxial Cable Ø10.3mm 25m
- 91-101139 Coaxial Cable Ø10.3mm 50m
- 91-101140 N Conn. (male) for Coaxial Cable Ø4.9mm
- 91-101186 N Conn. (male) for Coaxial Cable Ø10.3mm
- 91-101187 Crimping Tool for Coaxial Cable Ø4.9mm
- 91-101188 Crimping Tool for Coaxial Cable Ø10.3mm

Coaxial cables are delivered with one fixed N connector (outdoor mounting), another loose N connector and crimp parts comes with the cable. It is required to use an appropriate crimping tool for attaching the loose N connector.

NOTE: For further details on the cable and connectors, please contact Lars Thrane A/S. A coaxial cable up to a length of 500 meters can be used for connecting the LT-3110 Control Unit and the LT-3130 Antenna Unit. Details about the coaxial cable, specification, and cable lengths, are described in *LT-3130 Antenna Unit* on page 11.

System Overview

The LT-3100 Satellite Communications System is a standalone communication product, which is using the Iridium® satellite constellation. The LT-3100 system is working on the new Iridium® NEXT satellites. An overview of the LT-3100 system is illustrated in Figure 1.

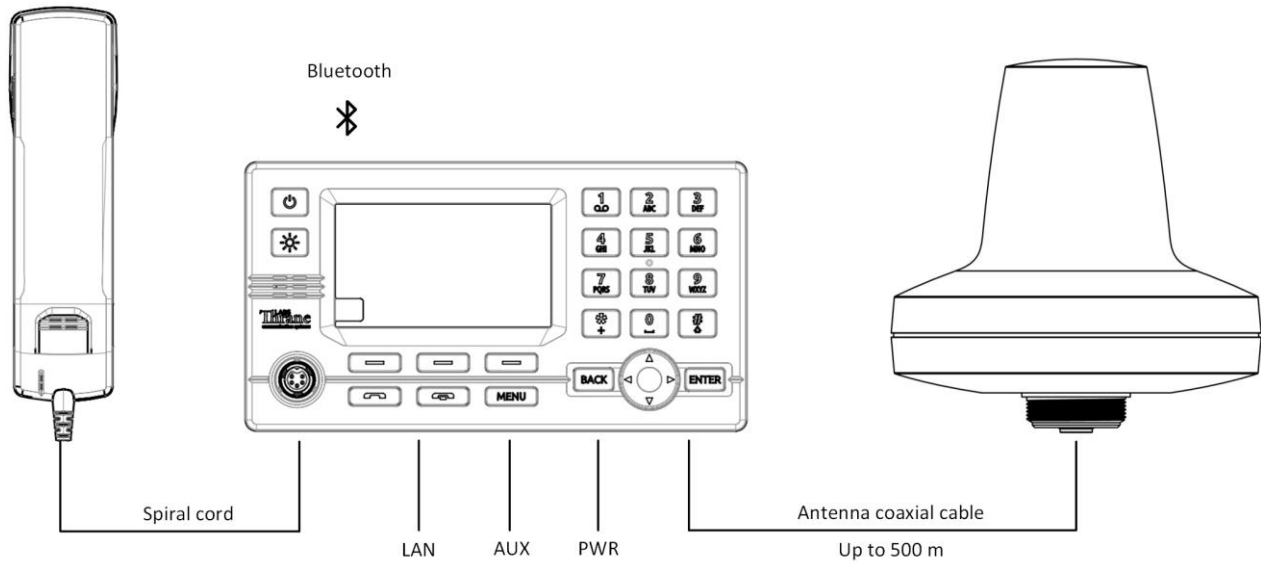

Figure 1: LT-3100 system - basic components and interfaces.

The LT-3100 system consists of the following units, provided by Lars Thrane A/S:

- LT-3110 Control Unit
- LT-3120 Handset
- LT-3121 Cradle
- LT-3130 Antenna Unit

Installation and Mounting

LT-3110 Control Unit

The LT-3110 Control Unit is the master unit in the system, supporting all external interfaces and the operational user interface. The LT-3110 Control Unit is designed for indoor mounting. Check the specifications in *App. G - Specifications* on page 145.

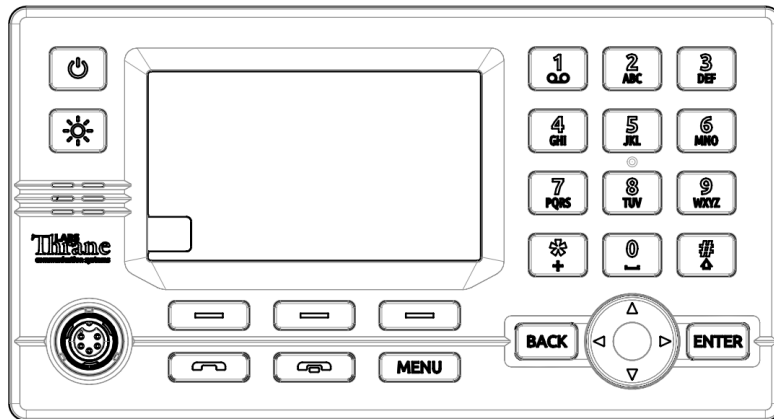

Figure 2: LT-3110 Control Unit (front view)

The LT-3110 Control Unit has the following interfaces:

- 4-pin power connector (male), marked 'PWR'
- Chassis ground connector, marked 'GNDC'
- N connector (female) for coaxial cable to the LT-3130 Antenna Unit, marked 'ANT'
- Ethernet (RJ-45) connector, marked 'LAN'
- 10-pin auxiliary connector (male), marked 'AUX'
- SIM card, marked 'SIM'
- 5-pin connector (female) for LT-3120 Handset (front of the control unit)

The interfaces on the back side of the LT-3110 Control Unit are illustrated in Figure 3 on page 7.

The LT-3110 Control Unit interfaces are described in *Interfaces* on page 27. The LT-3110 Control Unit, front and backside view, are illustrated in Figure 2 and Figure 3.

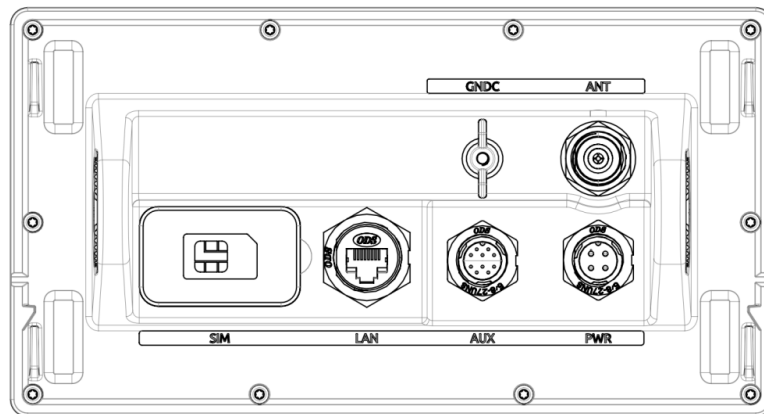

Figure 3: LT-3110 Control Unit (backside view).

The LT-3110 Control Unit user interface, display and buttons, are described in *User Interface (UI)* on page 42.

NOTE: The LT-3110 Control Unit must be mounted with either the Bracket Mount, Control Unit (P/N: 91-100771) or Flush Mount, Control Unit (P/N: 91-100772) - illustrated in Figure 4 and Figure 5. The Flush Mount, Control Unit is not included in the LT-3100 Satellite Communications System – Basic (P/N: 90-101142) and must be ordered separately.

Mounting and installation considerations:

For optimum system performance, the following guidelines on where to install and mount the LT-3110 Control Unit must be followed. It is recommended to mount the unit in a location, which fulfills these requirements:

- Mount the unit indoor (not exposed to direct water)
- Mount the unit using either the bracket mount or flush mount
- Mount the unit on a rigid structure with a minimum of exposure to vibration and shock
- Mount the unit in an area with an ambient temperature between -15°C to +55°C (+5°F to +131°F)

The Bracket Mount and Flush Mount for the LT-3110 Control Unit are illustrated in Figure 4 and Figure 5.

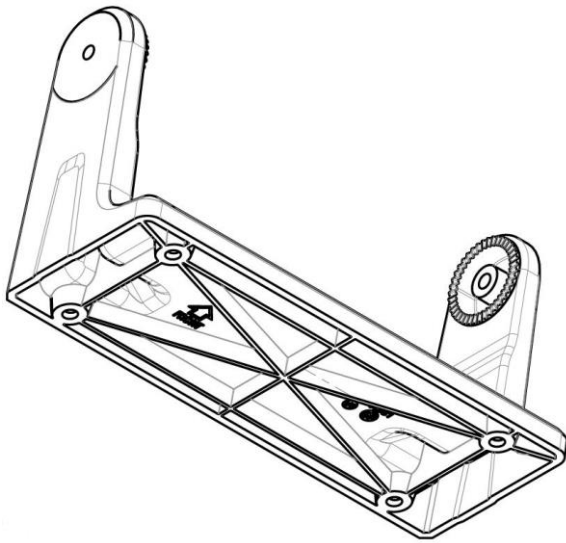

Figure 4: Bracket Mount, Control Unit.

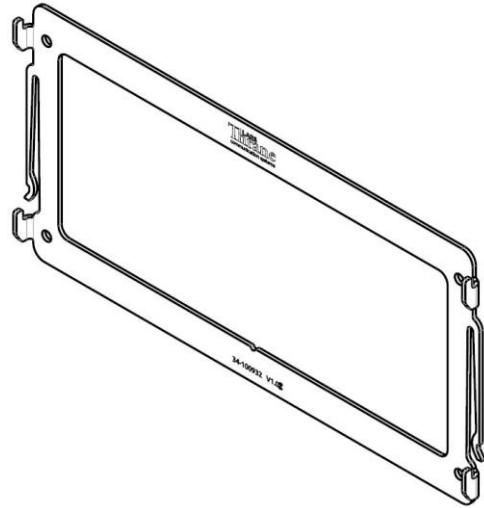

Figure 5: Flush Mount, Control Unit.

LT-3120 Handset

The LT-3120 Handset is the primary voice interface for the LT-3100 system. The LT-3120 Handset must be connected on the front of the LT-3110 Control Unit. The connector is illustrated in Figure 2 on page 6.

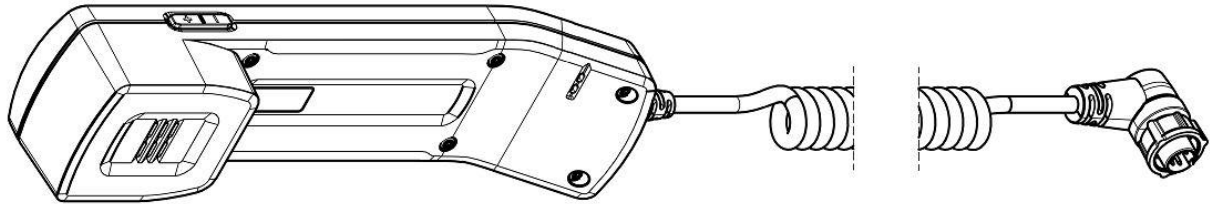

Figure 6: LT-3120 Handset (front view).

The LT-3120 Handset is connected to the LT-3110 Control Unit via a 5-pin proprietary angle connector. The spiral cord, fixed to the LT-3120 Handset is ~ 0.4 m from handset to connector, when coiled. The spiral cord can be stretched to a maximum of 2 m. The LT-3120 Handset is designed for indoor mounting. Check the specifications in *App. G - Specifications* on page 145.

The LT-3120 Handset has the following characteristics:

- High-performance audio speaker and microphone
- Separate ringer (buzzer)
- Speaker volume control (double-button, marked with '+' and '-', for volume up and down)
- Built-in off-hook detection circuit

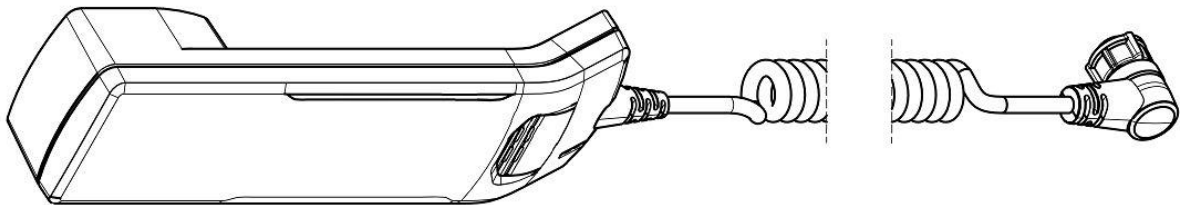

Figure 7: LT-3120 Handset (back view).

NOTE: The LT-3110 Control Unit will inform the user if the LT-3120 handset is not properly connected to the LT-3110 Control Unit. A BAM alert will be activated (Lost handset).

NOTE: The LT-3120 Handset must be operated together with the LT-3121 Cradle, for the off-hook detection circuit to work. The LT-3121 Cradle is described in *LT-3121 Cradle* on page 10.

LT-3121 Cradle

The LT-3121 Cradle is used together with the LT-3120 Handset. The LT-3121 Cradle should be mounted next to the LT-3110 Control Unit, supporting the LT-3120 Handset. The LT-3121 Cradle specifications are available in *App. G - Specifications* on page 145.

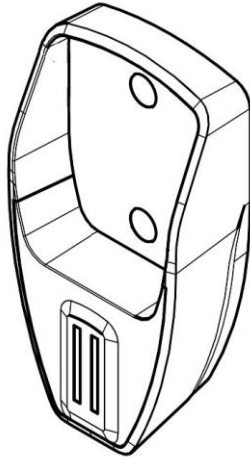

Figure 9: LT-3121 Cradle (front view).

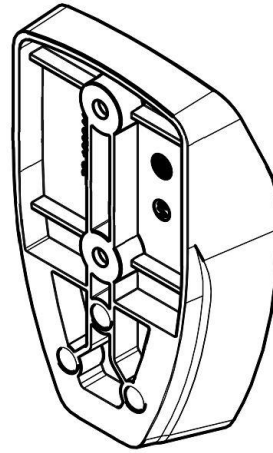

Figure 8: LT-3121 Cradle (backside view)

IMPORTANT: The LT-3121 Cradle contains a magnet, to hold on to the LT-3120 Handset. Make sure that other electronic equipment is installed in a distance respecting the compass safe distance of 0.4 m (1.3 ft).

An outline drawing for the LT-3121 Cradle is available in *App. P - Outline Drawing: LT-3121 Cradle* on page 154.

LT-3130 Antenna Unit

The LT-3130 Antenna Unit is designed for outdoor mounting and connected to the LT-3110 Control Unit via a coaxial cable. The LT-3130 Antenna Unit specifications are available in *App. G - Specifications* on page 145. The LT-3130 Antenna Unit has an N connector (female) mounted, centered at the bottom of the antenna.

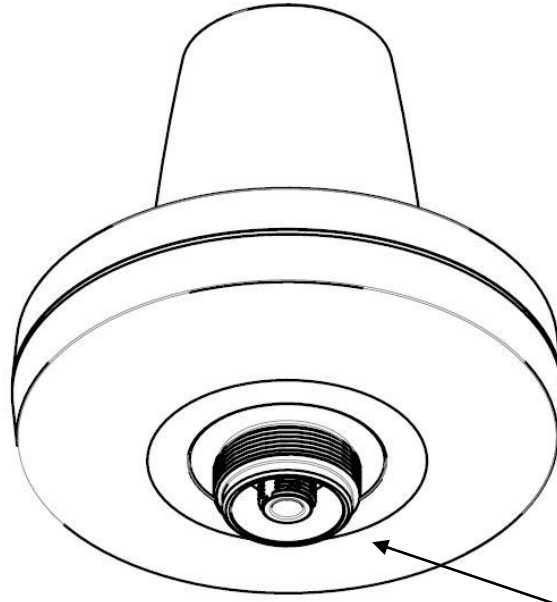

Figure 10: LT-3130 Antenna Unit.

The LT-3130 Antenna Unit has an N connector (female) at the bottom side of the unit.

Mounting and installation considerations:

- Mount the unit vertically (with the N connector pointing down)
- Mount the unit with free line of sight to the Iridium® and GNSS satellites. Make sure that the unit can receive signals from the Iridium® and GNSS satellites (satellite reception information is available in the LT-3110 Control Unit user interface display, see Figure 43 on page 43)
- Mount the unit on a rigid structure with a minimum of exposure to vibration and shock
- Mount the unit using either the Bracket Mount or Pole Mount provided by Lars Thrane A/S
- Mount the unit outdoor with an ambient temperature between -40°C to +55°C (-40°F to +131°F)
- Mount the unit with a minimum angle of 20 degrees towards a radar antenna (above or below) and keep a minimum distance of 2.5 m (8 ft)
- Mount the unit at least 1 m. (3 ft.) away from radio transmitting antennas (VHF, UHF, MF-HF)
- Mount the unit away from Inmarsat and transmitting VSAT antennas

NOTE: It is only the LT-3130 Antenna Unit marked with HVIN 2.00 (Unit Label) or newer that can be used for the LT-3100 Satellite Communications System. The LT-3100 software will check the antenna unit during power up and the system will not be operational, if connecting a legacy LT-3130 Antenna Unit.

To avoid breaking the LT-3130 Antenna Unit N-connector (female), it is important not to use tooling when connecting and fastening the coaxial cable N-connector (male) to the antenna unit. The coaxial cable N-connector thread nut must be fastened by hand only.



Figure 11: Connecting coaxial cable N-connector to the LT-3130 Antenna Unit

IMPORTANT: Maximum allowed torque is 2 Nm when connecting the coaxial cable N-connector (male) to the N-connector (female) of the LT-3130 Antenna Unit. No tooling must be used for fastening the coaxial cable thread nut as illustrated in Figure 11 above.

The LT-3130 Antenna Unit has a hazard warning label attached to the radome as illustrated in Figure 12.

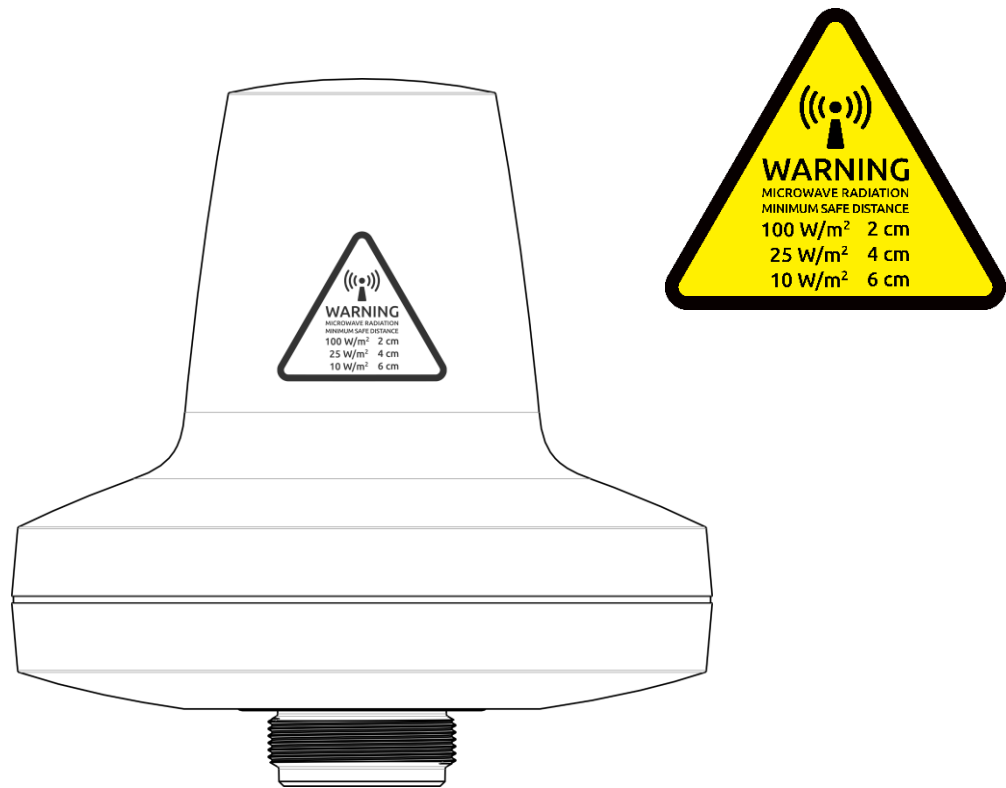

Figure 12: LT-3130 Antenna Unit (incl. warning label)

WARNING: The safety distance from the LT-3130 Antenna Unit, is 0.1 m (0.3 ft), in order to comply with the regional regulations.

IMPORTANT: Due to the adjacency of the Iridium and Inmarsat frequency bands, the LT-3130 Antenna Unit may not co-operate in the proximity of an active Inmarsat antenna unit, see *Coexisting with Inmarsat L-band* on page 18

The LT-3130 Antenna Unit must be installed outside the main beam of the radar. Typically, this is in the order of 10 degrees. To avoid near field antenna coupling, a minimum distance of 2.5 m (6 ft) between the radar antenna and the LT-3130 Antenna Unit must be obeyed. Figure 13 is illustrating how the LT-3130 Antenna Unit should be mounted to avoid interference from radars.

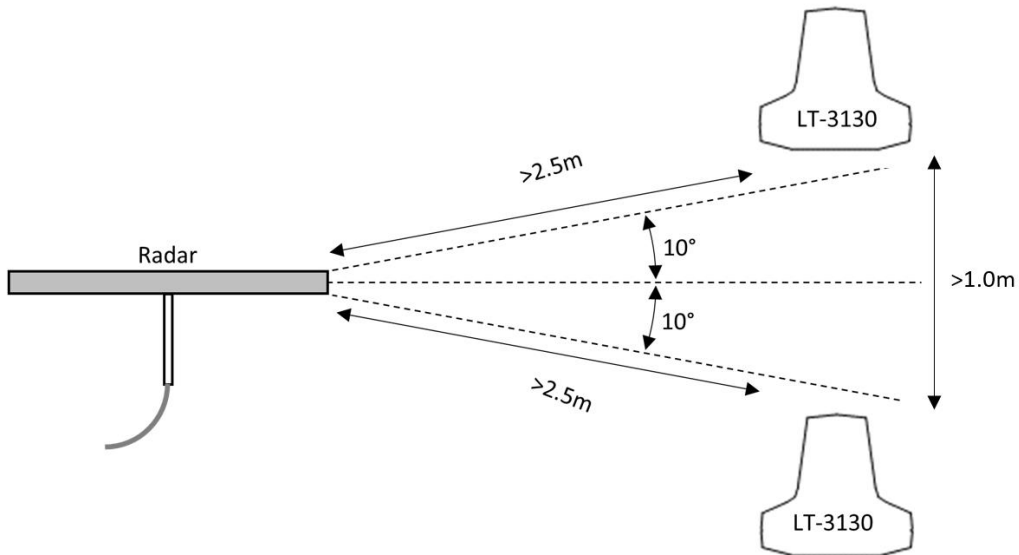

Figure 13: LT-3130 Antenna Unit – Avoid Radar Beam.

IMPORTANT: Failing to obey the specified installation conditions will void the warranty. However, depending on the specific radar frequency and power level, the separation distance between the radar and the LT-3130 Antenna Unit may be reduced, with no impact on the antenna performance. The performance of the LT-3130 Antenna Unit should be validated when the LT-3100 system is installed.

The LT-3130 Antenna Unit must be mounted minimum 1 m from MF-HF, VHF, and UHF antennas.

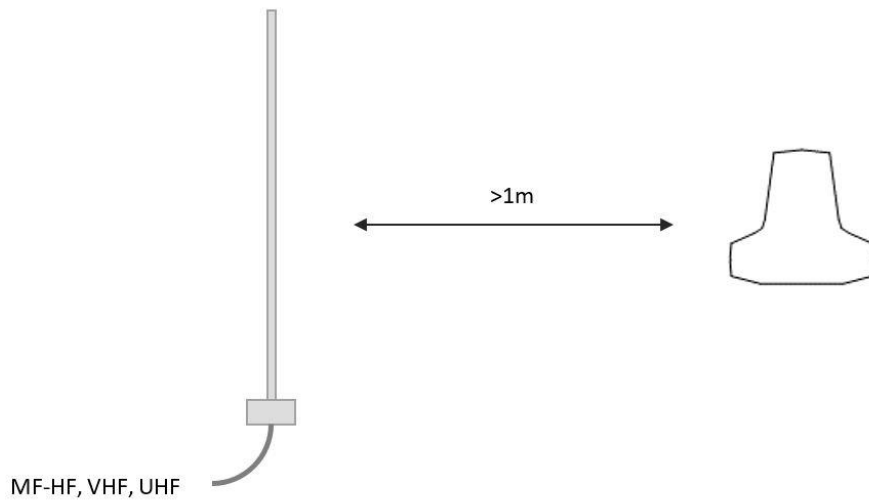

Figure 14: LT-3130 Antenna Unit – Separation to MF-HF, VHF, and UHF antennas.

NOTE: The LT-3130 Antenna Unit must be installed with a 360° clear view of the sky. However, minor obstructions such as a mast will not degrade the antenna performance severely, if a separation distance larger than 15 times the diameter of the obstruction is kept.

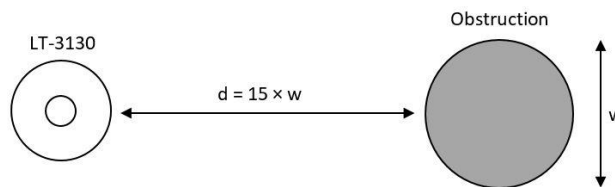

Figure 15: LT-3130 Antenna Unit – (separation distance to minor obstructions)

The LT-3130 Antenna Unit must be mounted using one of the mounts listed in Mounts(Mounts) on page 4

The LT-3130 Antenna Unit must be mounted with free line of sight to the Iridium satellites for best possible performance. The best location will typically be at the top of the lantern mast, where there are no obstructions blocking the Iridium satellite link. The LT-3130 Antenna Unit is designed to maintain a communication link to the Iridium satellites in all weather conditions, see Table 2.

Extreme Ship Motion Values & Clear View Angles Below the Horizontal Plan			
Motion Direction	Maximum Amplitude	Iridium Satellite Acq.	Clear View Angle Below the Horizontal Plan
Roll	±30°	+8°	-22°
Pitch	±10°	+8°	-2°

Table 2: LT-3130 AU Roll and Pitch Clear View Angles (below the horizontal plan)

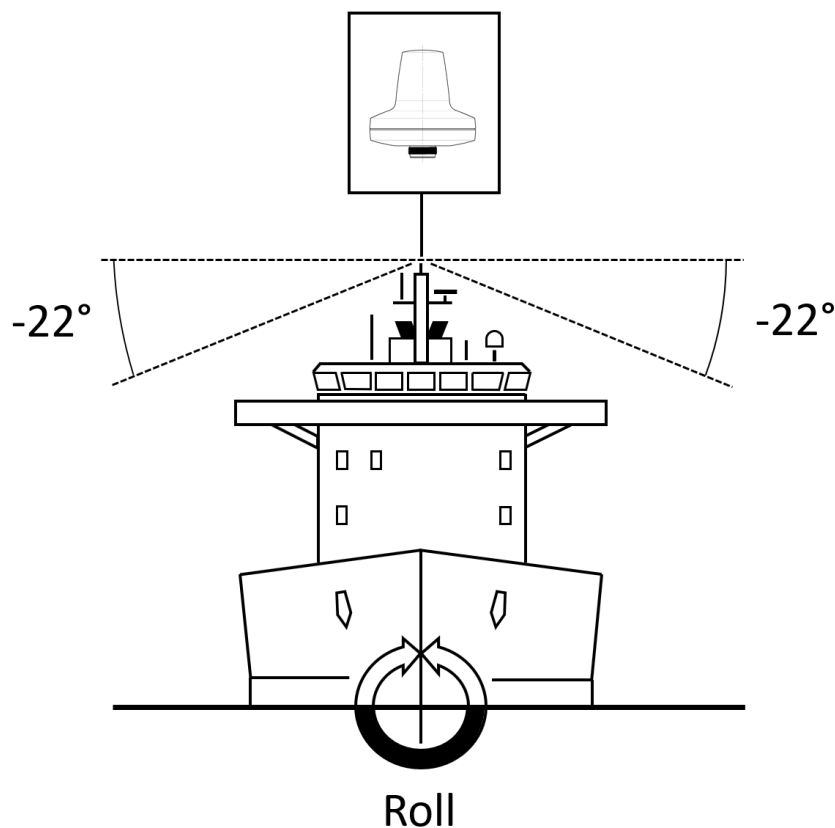

Figure 16: LT-3130 AU Installation (roll: clear view angle below the horizontal plan)

NOTE: The LT-3130 Antenna Unit must be mounted with a -22° clear view angle below the horizontal plan (port and starboard directions), where no obstructions must block the Iridium satellite signal, to maintain full functionality under extreme roll conditions. Also, the upper hemisphere must also be without any blockages to the Iridium satellites.

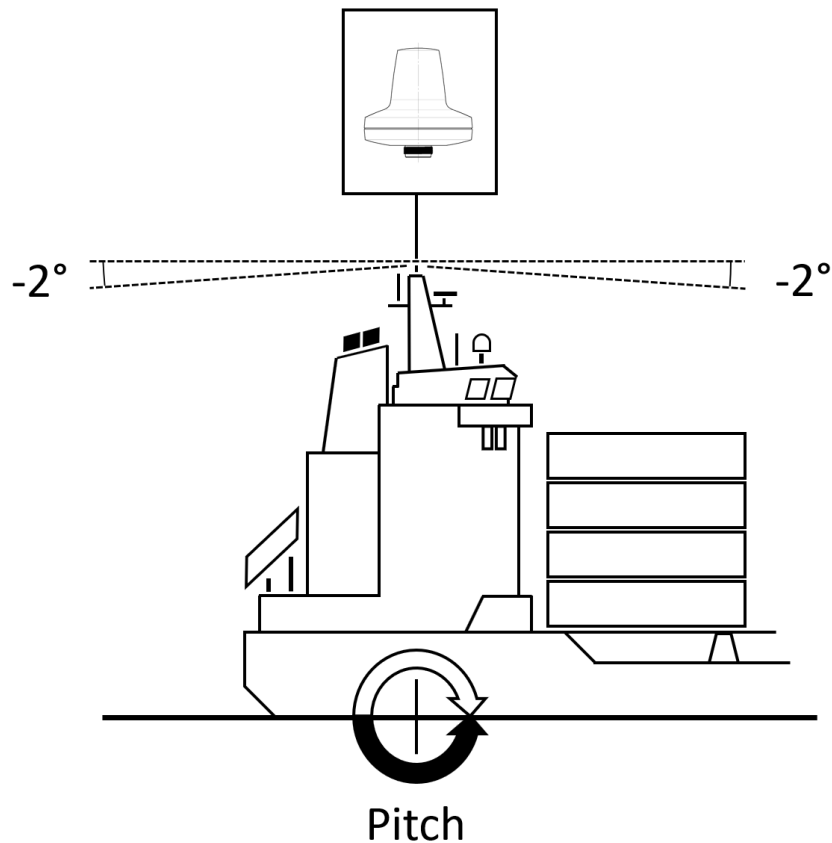

Figure 17: LT-3130 AU Installation (pitch: clear view angle below the horizontal plan)

NOTE: The LT-3130 Antenna Unit must be mounted with a -2° clear view angle below the horizontal plan (fore and after directions), where no obstructions must block the Iridium satellite signal, to maintain full functionality under extreme pitch conditions. Also, the upper hemisphere must be without any blockages to the Iridium satellites.

IMPORTANT: For best possible performance of the LT-3100 system, the LT-3130 Antenna Unit must have free line of sight to the Iridium satellites as illustrated in Figure 16 and in Figure 17 (clear view angle below the horizontal plan). To have the best possible obstructions should be below the marked lines of these two illustrative figures.

Coexisting with Inmarsat L-band

It is possible to install the LT-3100 system onboard a vessel that already has Inmarsat C equipment installed.

It is important to note that the LT-3130 Antenna Unit must be mounted below the Inmarsat C antenna with a minimum distance of 1 m and below an angle of minimum 15° when coexistence is required.

Practical use of the LT-3100 system during Alpha and Beta Sea trials, installed onboard vessels with Inmarsat equipment, has not revealed any degradation in system performance.

Survival distances:

Mount the LT-3130 Antenna Unit at a minimum distance of 1 m from an Inmarsat C antenna.

Mount the LT-3130 Antenna Unit at a minimum distance of 3 m from an Inmarsat Fleet Broadband antenna.

Bracket Mount (1.5" to 2.5" pipe), Antenna Unit

The new Cable Hose designed for the Bracket Mount (1.5" to 2.5" pipe), Antenna Unit must be used going forward as part of the installation. Part Number (P/N): 91-100773 will be replaced with P/N: 91-102469 (including the Cable Hose). The Cable Hose is illustrated with the bracket Mount (1.5" to 2.5" pipe), Antenna Unit in Figure 18. The new Cable Hose must be used to protect the LT-3130 Antenna Unit (P/N: 51-100989) and coaxial cable N connector from corrosion over time. The Cable Hose can be ordered separately from Lars Thrane A/S on the following P/N: 91-102470 Cable Hose (standalone).

The Cable Hose, incl. installation steps, is more detailed illustrated in document: 43-100773 Bracket Mount Assembly (Illustrations).

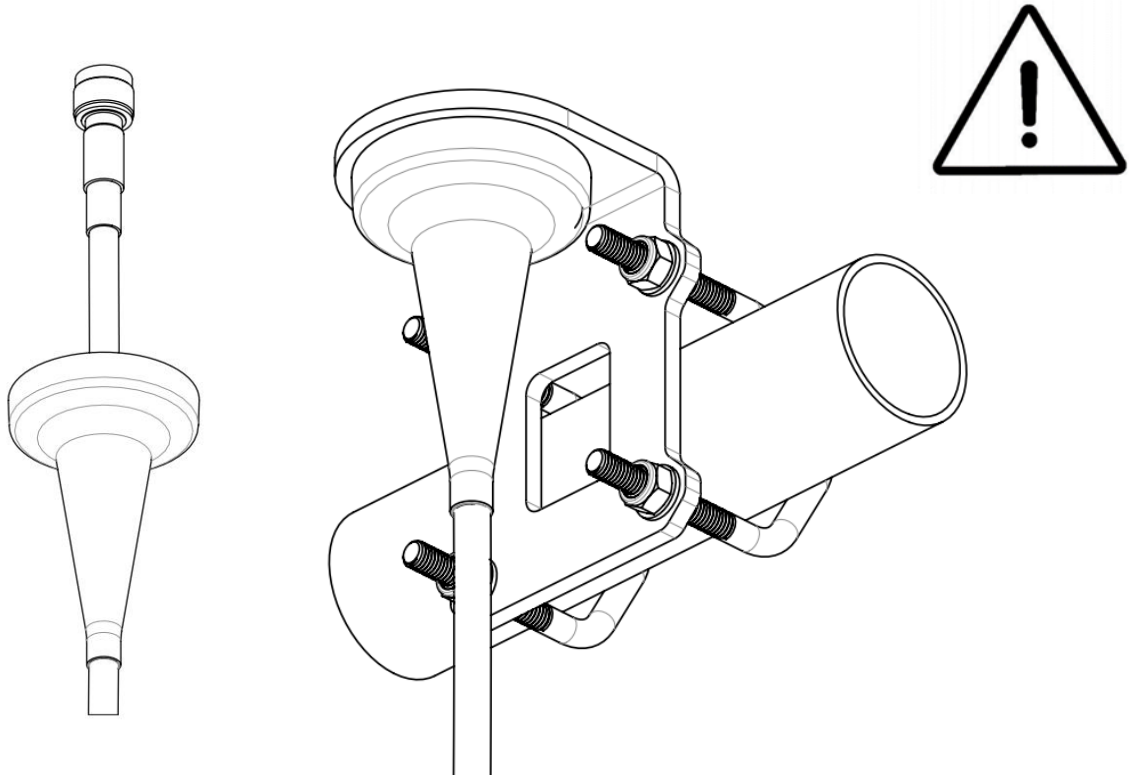

Figure 18: Bracket Mount (1.5" to 2.5" pipe), Antenna Unit with Cable Hose

IMPORTANT: The Cable Hose illustrated above with the Bracket Mount (1.5" to 2.5" pipe), Antenna Unit must be used as part of the installation.

NOTE: The 91-102469 Bracket Mount (1.5" to 2.5" pipe), Antenna Unit has been discontinued. Please use 91-100774 Pole Mount (1.5" pipe, 38.8mm), Antenna Unit or 91-102520 Pole Mount (2.0" pipe, 53.0mm), Antenna Unit.

For additional questions about installation of the Bracket Mount (1.5" to 2.5"), Antenna Unit and Cable Hose, please contact your local distributor.

The Bracket Mount (1.5" to 2.5" pipe), Antenna Unit installation options are illustrated in Figure 19 to Figure 24.

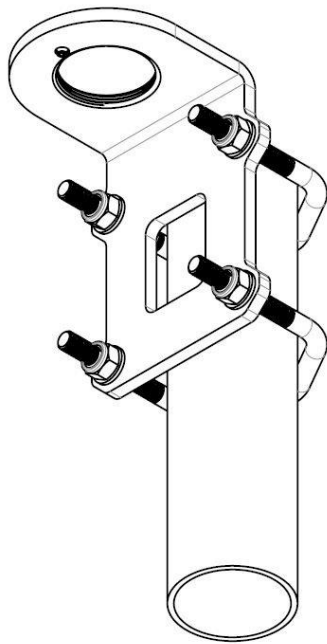

Figure 20: Bracket Mount (1.5" to 2.5" pipe), Antenna Unit – vertical pipe mount.

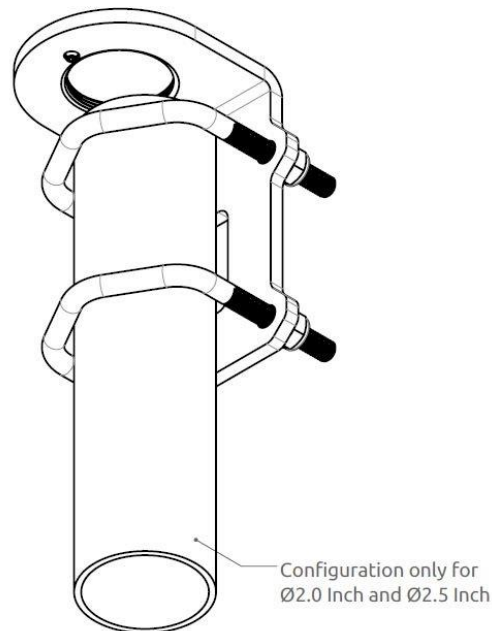

Figure 19: Bracket Mount (1.5" to 2.5" pipe), Antenna Unit – vertical pipe mount.

Bracket mount installation procedure:

1. Fasten the bracket mount to a pipe (max. 2.5" pipe) by using the two V-bolts and the M8 prevailing nuts, as illustrated in Figure 22 on page 21 (max torque = 5.5 Nm)
2. Screw on the LT-3130 Antenna Unit and secure the antenna lock pinot (max torque = 1.2 Nm)
3. Fasten the coaxial cable to the LT-3130 Antenna Unit (N connector)
4. Apply self-volcanic tape on the N connector and cable to protect against saltwater and corrosion or use the recommended Cable Hose

NOTE: Always fasten the Bracket Mount, Antenna Unit (1.5" to 2.5" pipe) to the pipe, before installing the LT-3130 Antenna Unit (the antenna unit and bracket mount are fastened together by the thread lock). Remember to secure the pinot screw after the antenna unit has been fastened. The torques are specified in Figure 22 on page 21.

NOTE: The Bracket Mount (1.5" to 2.5" pipe), Antenna Unit interfaces to a pipe of maximum 2.5" (63.5 mm), measured outer diameter.

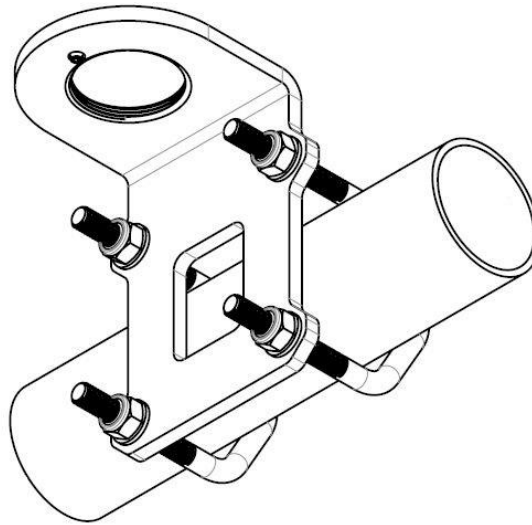

Figure 21: Bracket Mount (1.5" to 2.5" pipe),
Antenna Unit – horizontal pipe mount.

The Bracket Mount (1.5" to 2.5" pipe), Antenna Unit can support pipes in the interval 1.5" to 2.5". The torques are specified in Figure 22. The bracket mount, V-bolts, and nuts are all made of A4 stainless steel

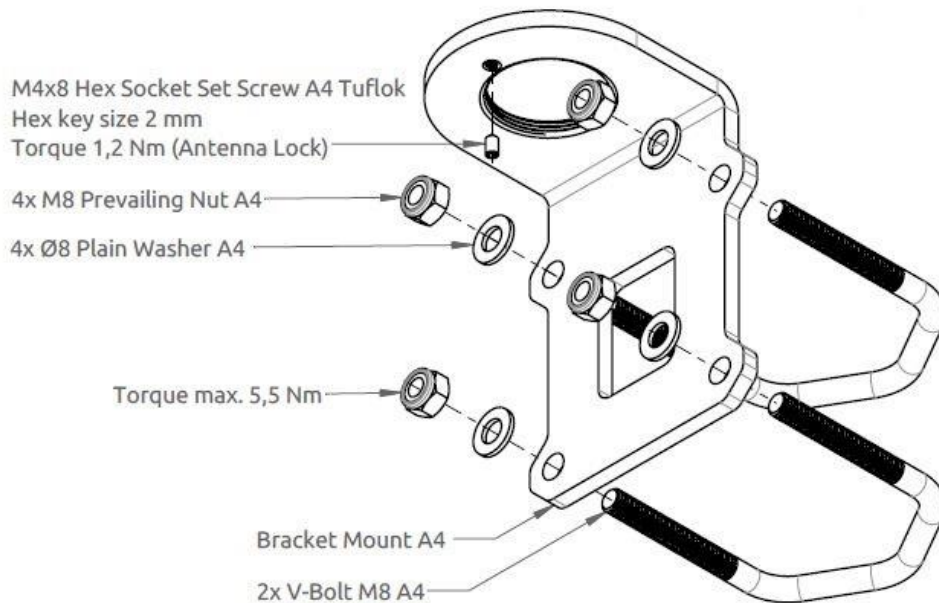

Figure 22: Bracket Mount (1.5" to 2.5" pipe), Antenna Unit – (horizontal pipe mount)

To avoid corrosion issues when using the Bracket Mount (1.5" to 2.5" pipe), Antenna Unit - it is recommended to use the cable hose as illustrated in Figure 23 and in Figure 24. The cable hose consists of a UV resistant silicone pipe and an aluminum anodized thread block, which can be fastened to the LT-3130 Antenna Unit providing protection to the coaxial cable N connector and surroundings.

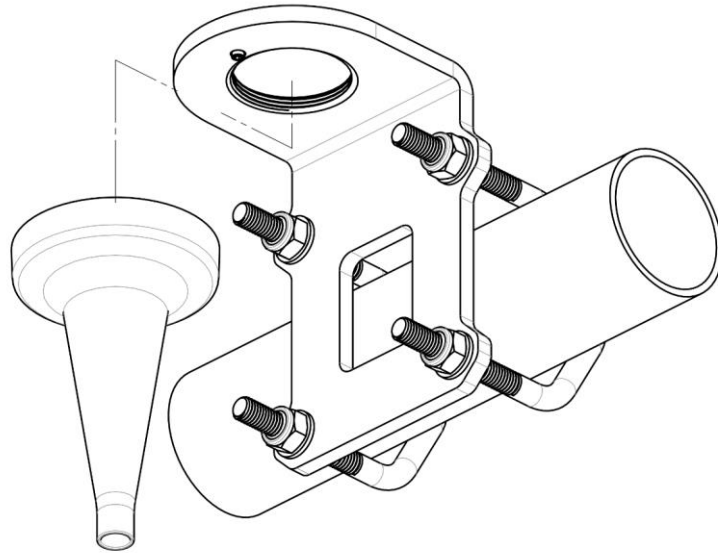

Figure 23: Bracket Mount (1.5" to 2.5" pipe), Antenna Unit with Hose

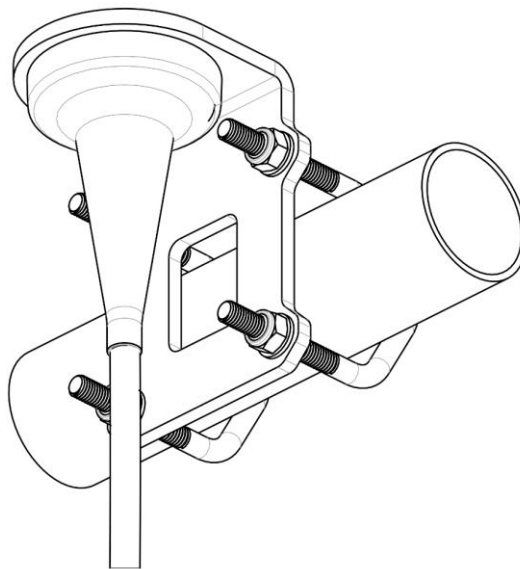
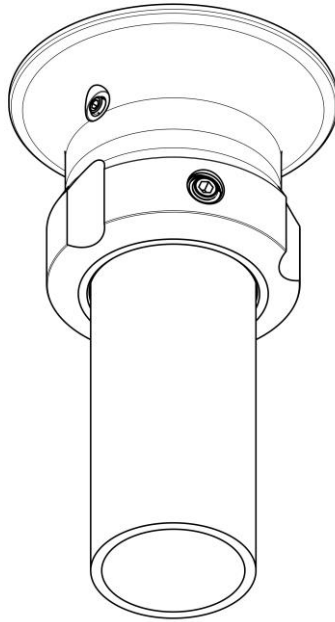

Figure 24: Bracket Mount (1.5" to 2.5" pipe), Antenna Unit with Hose

NOTE: The cable hose will be included in the new ordering number for the Bracket Mount (1.5" to 2.5" pipe), Antenna Unit. The cable hose can also be ordered separately. See *Mounts* on page 4 for more details on the ordering numbers regarding the cable hose.

Pole Mount (1.5" pipe, 38.8 mm), Antenna Unit

The Pole Mount (1.5" pipe), Antenna Unit is illustrated in Figure 25 to Figure 27.



*Figure 25: Pole Mount (1.5" pipe),
Antenna Unit.*

Pole mount installation procedure:

1. Feed the coaxial cable through the pole mount
2. Fasten the coaxial cable to the LT-3130 Antenna Unit (N connector)
3. Apply self-vulcanic tape on the N connector and cable to protect against saltwater and corrosion
4. Screw the pole mount (clockwise) on the LT-3130 Antenna Unit, and fasten the antenna lock pinot screw, as illustrated in Figure 27 (max torque = 1.2 Nm)
5. The LT-3130 Antenna Unit and pole mount can now be mounted on the 1.5" pipe. Fasten the three pole lock pinot screws, as illustrated in Figure 26 (max torque = 4.5 Nm)

NOTE: Remember to fasten the antenna lock pinot screw (1.2 Nm) after the pole mount and antenna unit have been screwed together.

NOTE: The Pole Mount (1.5" pipe), Antenna Unit interfaces to a pipe of maximum 1.5" (38.1 mm), measured outer diameter.

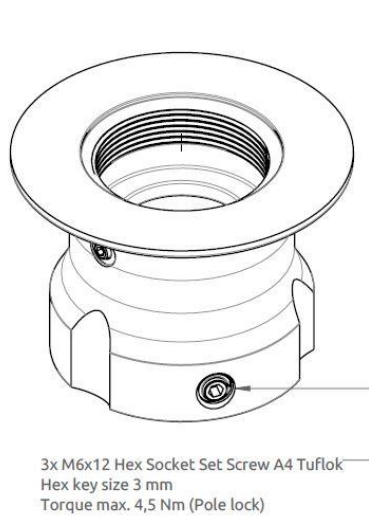

Figure 26: Pole Mount (1.5" pipe), Antenna Unit.

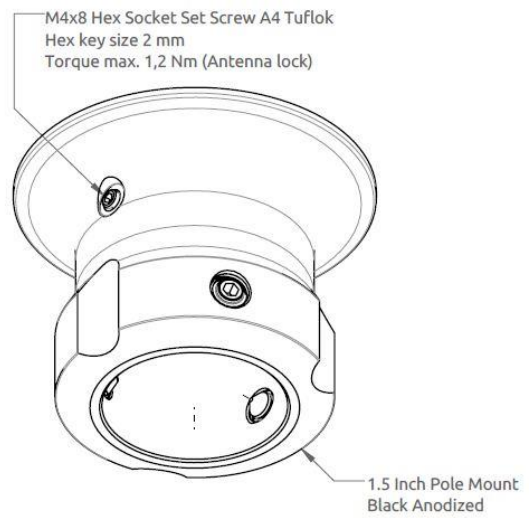

Figure 27: Pole Mount (1.5" pipe), Antenna Unit.

NOTE:

The Pole Mount (1.5" pipe), Antenna Unit only supports a 1.5" pipe. The pinot screws (antenna and pole lock) torques are specified in Figure 26 and Figure 27. The pole mount is made of milled aluminum (anodized). The pinot screws are made of A4 stainless steel.

Pole Mount (2.0" pipe, 53.0 mm), Antenna Unit

The Pole Mount (2.0" pipe, Ø53.0 mm), Antenna Unit is illustrated in Figure 28 to Figure 30.

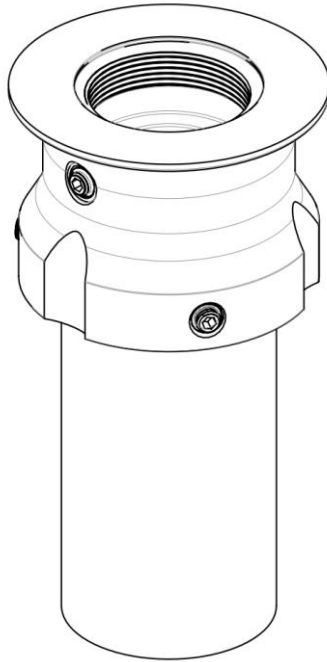

Figure 28: Pole Mount (2.0" pipe, Ø53.0 mm), Antenna Unit.

Pole mount installation procedure:

1. Feed the coaxial cable through the pole mount
2. Fasten the coaxial cable to the LT-3130 Antenna Unit (N connector)
3. Apply self-vulcanic tape on the N connector and cable to protect against saltwater and corrosion
4. Screw the pole mount (clockwise) on the LT-3130 Antenna Unit, and fasten the antenna lock pinot screw, as illustrated in Figure 30 (max torque = 1.2 Nm)
5. The LT-3130 Antenna Unit and pole mount can now be mounted on the 2.0" pipe. Fasten the three pole lock pinot screws, as illustrated in Figure 29 (max torque = 4.5 Nm)

NOTE: Remember to fasten the antenna lock pinot screw (1.2 Nm) after the pole mount and antenna unit have been screwed together.

NOTE: The Pole Mount (2.0" pipe, Ø53.0 mm), Antenna Unit interfaces to a pipe of maximum 2.0" (53.0 mm), measured outer diameter.

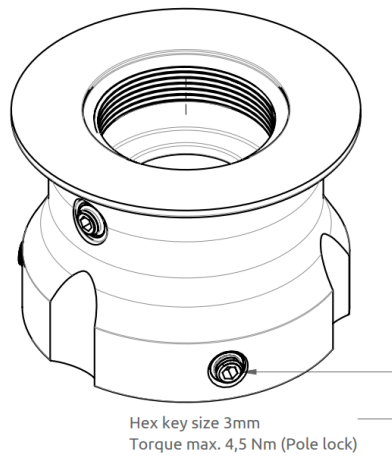

Figure 29: Pole Mount (2.0" pipe, Ø53.0 mm), Antenna Unit.

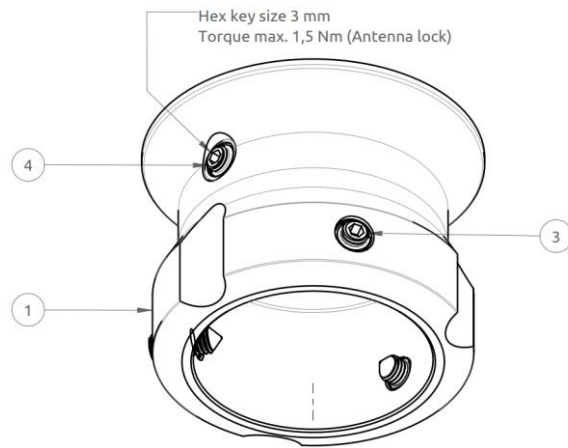

Figure 30: Pole Mount (2.0" pipe, Ø53.0 mm), Antenna Unit.

NOTE: The Pole Mount (2.0" pipe, Ø53.0mm), Antenna Unit only supports a 2.0" pipe. The pinot screws (antenna and pole lock) torques are specified in Figure 29 and Figure 30. The pole mount is made of milled aluminum (anodized). The pinot screws are made of A4 stainless steel.

Interfaces

LT-3110 Control Unit

This section will describe all the external interfaces from the LT-3110 Control Unit.

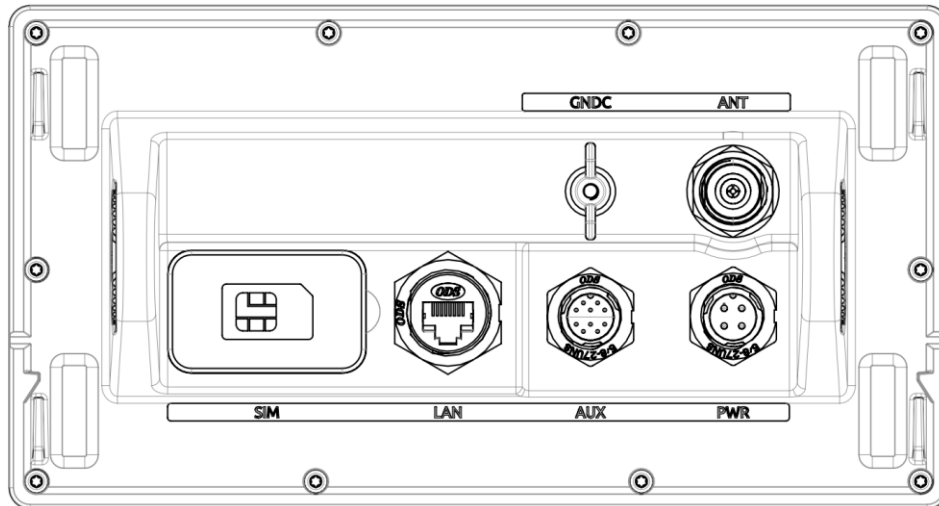

Figure 31: LT-3110 Control Unit (back view)

DC input (PWR)

The LT-3100 system is designed to be used on 12 VDC and 24 VDC power buses (nominal). External DC power to the LT-3100 system is provided by connecting the proprietary 91-102118 Power Cable, 3m - delivered by Lars Thrane A/S. The power connector is mounted on the back side of the LT-3110 Control Unit and marked 'PWR', see Figure 31.

The power source for the LT-3100 system must comply with the regulations and the associated standards, minimum is compliance to IEC 60945 (2002). When extending the power supply cables the positive (+) and the negative (-) must be installed closely together in order to keep the cable inductance low.

NOTE: Make sure to use a galvanic isolated power supply, see *Galvanic Isolated Power Supply* on page 41.

NOTE: The input voltage range is: 12-24 VDC. The LT-3110 Control Unit DC input connector and circuit is protected and certified for *Reverse Polarity Protection*.

NOTE: A power connector (4-pole) is used for the LT-3110 Control Unit. This power connector requires the new 91-102118 power cable, 3m from Lars Thrane A/S. Use only the 91-102118 power cable, 3m delivered by Lars Thrane A/S. If power connector (2-pole) is used for the LT-3110 Control Unit, then use the 91-100767 power cable, 3m delivered by Lars Thrane A/S.

Chassis ground

The chassis ground connector is placed on the back side of the LT-3110 Control Unit and marked with 'GNDC', see Figure 31 on page 27.

SIM card (SIM)

The LT-3100 system requires a SIM card to be operated with the Iridium® satellite services. The Iridium® SIM card must be bought from one of the official Iridium® Service Providers. A list of Iridium® Service Providers can be found at the Iridium® website: <https://www.iridium.com> (select 'Services', and hereafter 'Voice').

The SIM card must be inserted in the LT-3110 Control Unit behind the rubber dust cover. Make sure that the LT-3110 Control Unit is powered off before opening the rubber dust cover. When the SIM card is properly inserted in the slot, and the rubber dust cover is secured, the LT-3110 Control Unit can be powered up. The rubber dust cover is illustrated in Figure 31 on page 27 and marked with 'SIM'.

The following procedure must be followed when inserting, replacing, or removing the SIM card:

1. Turn off the power to the LT-3110 Control Unit
2. Remove the rubber dust cover on the back side of the LT-3110 Control Unit
3. Slide the SIM card holder as illustrated with the arrows on the PCB print, to unlock
4. Open the SIM card holder and insert or remove the SIM card
5. Close the SIM card holder
6. Slide the SIM card holder as illustrated with the arrows on the PCB (opposite direction), to lock
7. Re-insert the rubber dust cover
8. Turn on power to the LT-3110 Control Unit

NOTE: The LT-3110 Control Unit must be powered off when inserting, changing, or removing the SIM card. The SIM card is hidden behind the rubber dust cover on the back side of the LT-3110 Control Unit.

Figure 32 is showing an Iridium SIM card. The format is Mini-SIM (2FF) 25 x 15 mm. The SIM card must be removed from the full-sized card carrier by breaking the Mini-SIM out. The full-sized card carrier contains the MSISDN number, while the SIM card itself contains the ICCID.

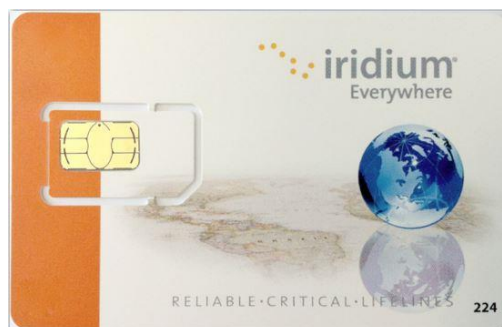

Figure 32: Iridium SIM card

The SIM card will be delivered from the Iridium Service Provider (ISP) together with the essential information:

- MSISDN number (the Iridium voice number)
- ICC-ID
- PIN codes
- PUK codes

The SIM card will be delivered with the SIM lock feature disabled. Thus, the LT-3100 system will be operational as soon as the SIM card is inserted.

If the user decides to activate the SIM lock function from the UI display, then the PIN code is required next time the LT-3100 system is powered up. Change of the SIM card PIN code can only be performed, if the PIN lock is enabled. If changing the SIM card PIN code, then the SIM card default PIN code cannot be restored, and the new PIN code must be used to unlock the SIM card and the Iridium services.

Ethernet RJ45 (LAN)

The LT-3110 Control Unit has an Ethernet LAN (RJ-45) interface, currently supporting service & maintenance. The Ethernet interface must be used to access the built-in web server, which is further described in *Web server* on page 100.

The LT-3110 Control Unit will automatically request and obtain an IP address when connected to a Local Area Network (LAN) with a DHCP server (e.g. a router). If connecting the LT-3110 Control Unit directly to a PC, the two will automatically negotiate an IPv4 Link-Local address. The current IP address can be found in the user interface display (Menu -> System -> Network: IP Address).

Auxiliary (AUX)

The auxiliary connector is a 10-pin connector (male) mounted on the backside of the LT-3110 Control Unit as illustrated in Figure 31 on page 27 and marked with ‘AUX’. The auxiliary connector supports the following interfaces.

- RS-422 serial interface
- 2 x Input/output (I/O)

The Auxiliary connector / cable pin out and wire designation are illustrated in Figure 33, Figure 34, and in Table 3.



Figure 33: AUX connector pin out



Figure 34: AUX cable pin out

Auxiliary (AUX) Cable		
Pin No.	Wire Color	Wire Designation
1	Black	External Ringer (ground)
2	Brown	External Ringer (output)
3	Red	RS422 Z (output) TxD-
4	Orange	RS422 Y (output) TxD+
5	Yellow	RS422 A (input) RxD+
6	Green	RS422 B (input) RxD-
7	Blue	Radio Silence (input)
8	Violet	Radio Silence (ground)
9	Gray	Not Used
10	White	RS422 C (ground)

Table 3: AUX Cable

NOTE: Use only the 91-100768 Auxiliary Cable, 3m delivered by Lars Thrane A/S for connecting to the AUX connector on the backside of the LT-3110 Control Unit. The Auxiliary Cable, 3m is an accessory part and must be acquired separately.

The LT-3110 Control Unit is supporting external ringer functionality on the Auxiliary (External I/O) interface, which can be configured from the web server, see *External – I/O* on page 123.

The LT-3110 Control Unit is supporting GNSS and BAM on the Auxiliary (RS-422) interface, which can be configured from the web server, see *GNSS and BAM* on page 124.

External Output and Input are further described on the next pages.

RS-422 Circuit Diagram (LT-3110 CU – Aux Connector)

Figure 35 shows the RS-422 circuit diagram used for the LT-3110 Control Unit (Aux connector).

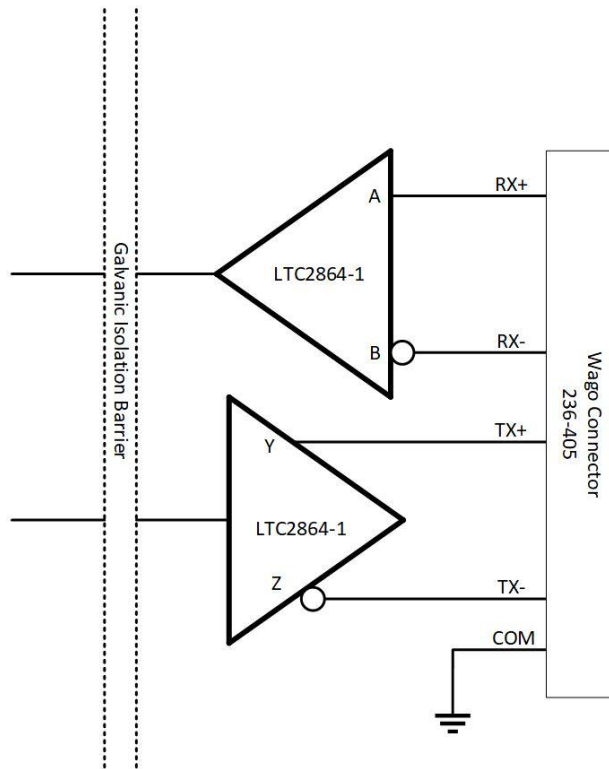

Figure 35: RS-422 Circuit Diagram for the LT-3110 CU

Interface Drive Capability as a Talker and Listener

- A(Rx+), B(Rx-), Y(Tx-): -60V to +60V
- Short circuit protected
- Galvanic isolated up to 1500V

External Output (External Ringer)

The LT-3100 system support connection of an external speaker for incoming call notifications. Connection of the external speaker must be completed as illustrated in Figure 36, incl. a relay. The maximum voltage and current for the relay are illustrated in the figure. Aux Cable Pin 2 External Output (Pin2) and External Output (Pin1) designation and wire colors are listed in Table 3 on page 31.

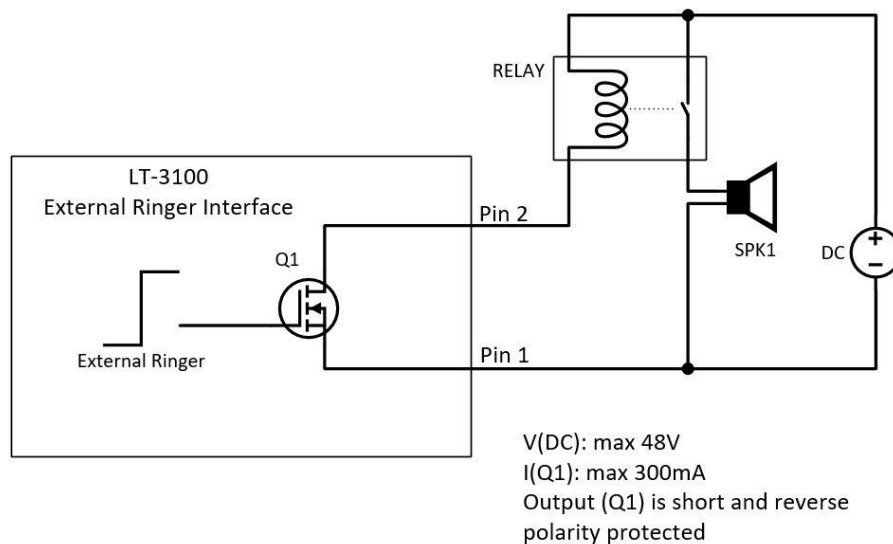

Figure 36: External Ringer diagram

NOTE: The External Ringer functionality must be configured in the web server, Configuration – External I/O, described in *External – I/O* on page 123.

External Input

The LT-3100 system is not supporting any functionality for the External I/O Input.

RS-422 (GNSS, BAM, and MSI)

The LT-3100 system Auxiliary RS-422 (bi-directional) interface can be configured to support different functions. The following functions are supported:

- GNSS (see *GNSS sentences* on page 97)
- BAM (see *BAM sentences* page 98)

The RS-422 interface can be configured using the web server, see *GNSS and BAM* on page 124.

N Connector (ANT)

The LT-3110 Control Unit has a N Connector (male) for the interface to the LT-3130 Antenna Unit. The N Connector interface is providing data communication and power to the antenna unit over a coaxial cable. The N connector marked with 'ANT' is illustrated on Figure 3 on page 7.

NOTE: Do not connect or disconnect the antenna cable when the LT-3110 Control Unit is powered.

Bluetooth

The LT-3110 Control Unit has built in Bluetooth 4.0 with integrated antenna providing wireless communication between Bluetooth capable devices and the LT-3100 system.

Max Power: RF Tx Power 10 dBm

NOTE: The Bluetooth interface and pairing is described in *Bluetooth* on page 74.

LT-3130 Antenna Unit

The LT-3110 Control Unit and the LT-3130 Antenna Unit must be connected using a coaxial cable. Both the control unit and the antenna unit have a N connector (female) mounted. This section will specify the requirements to the coaxial cable. The RF and DC requirements are specified in Table 4 and Table 5.

RF Coaxial Cable Requirements	
Requirement	Specification
Cable impedance	50 Ω
Maximum signal loss	45 dB/100 m @ 1.5 GHz

Table 4: RF Coaxial Cable Requirements

In most cases it will be the DC resistance that will determine the maximum length of the coaxial cable. It is important to note that the input voltage of the control unit is important for the length of the coaxial cable that can be used.

DC Coaxial Cable Requirements	
Power Source	Maximum DC Resistance
12 VDC	1.7 Ω
24 VDC	5.5 Ω

Table 5: DC Coaxial Cable Requirements

NOTE: The DC coaxial cable resistance that is listed in Table 5 and used to calculate the maximum cable length is the sum of the DC inner conductor resistance and the DC outer conductor resistance. Some data sheets are not providing enough information about the DC resistance, in which cases, the cable manufacture must be approached to obtain this information.

Lars Thrane A/S has calculated the maximum allowed cable lengths with two coaxial cables as illustrated in Table 6. The two coaxial cables are FF195LSFROH (~RG-58) and FF400LSFROH (~RG-214/LMR400).

Maximum Coaxial Cable Length		
Cable Type	12 VDC Supply	24 VDC Supply
FF195LSFROH (4.9mm)	41 m	135 m
FF400LSFROH (10.3mm)	154 m	500 m

Table 6: Maximum coaxial cable length (cable examples)

The cable lengths calculated in Table 6 are obtained by using the maximum DC resistance [Ω] from Table 5 and compare these maximum DC requirements with the actual DC resistance [Ω/km] of the specific coaxial cables. The FF400LSFROH and FF195LSFROX total DC resistance numbers are listed in Table 7 on page 37.

The total DC resistance for the two cables (FF195LSFROH and FF400LSFROH) are:

Total DC Resistance (Inner and Outer Conductor)			
Cable Type	Inner Conductor DC Resistance [Ω /km]	Outer Conductor DC Resistance [Ω /km]	Total DC Resistance [Ω /km]
FF195LSFROH (4.9 mm)	24.9	15.8	40.7
FF400LSFROH (10.3 mm)	4.5	6.5	11

Table 7: Total DC resistance (cable examples)

IMPORTANT: If using a coaxial cable that is different to what is specified in this section (FF195LSFROH and FF400LSFROH), then verify that the RF and DC coaxial cable requirements (Table 4 and Table 5) are respected and calculate the maximum cable length as a function of the input voltage and the total DC resistance. Contact Lars Thrane A/S to get assistance on selection and acceptance of a specific coaxial cable.

NOTE: The LT-3110 Control Unit must be powered off when connecting or disconnecting the LT-3130 Antenna Unit.

Power Consumption

The LT-3100 system is powered from 12 VDC or 24 VDC power source. This section will provide power consumption details for maximum power consumption and typical average power consumption.

Maximum

The LT-3100 system maximum power consumption is listed in Table 8 and in Table 9. The maximum power consumption is calculated with activity on all interfaces. The LT-3130 Antenna Unit has a built-in heater, which is activated only when the 24 VDC input power source is available.

24 VDC Maximum Power Consumption (Watt)	
System Unit	Power [W]
Total Power (maximum)	40.8

Table 8: Maximum Power Consumption (24 VDC input)

12 VDC Maximum Power Consumption (Watt)	
System Units	Power [W]
Total Power (maximum)	26.4

Table 9: Maximum Power Consumption (12 VDC input)

The coaxial cable length is an adding factor to the total power consumption of the system. A short coaxial cable will add approximately ~0 W to the total power consumption. Whereas a coaxial cable with a maximum length will add ~16 W (24 VDC input) and ~10 W (12 VDC input) to the total power consumption. The supported coaxial cable lengths for the LT-3100 system are described in *LT-3130 Antenna Unit* on page 36.

DC Isolation Resistance and Chassis Ground

The LT-3100 system must be installed properly with respect to DC isolation resistance and chassis ground. Wrong installations can lead to DC isolation issues (low Ohm meter measuring) on board the vessel and equipment damages. This section will provide details about installation precautions, which must be followed.

LT-3110 Control Unit (back view) with an upscaled power connector are illustrated in Figure 37. The Chassis ground (GNDC) must be connected sufficiently to the vessel ground. 91-102218 Power Cable, 3m must be used to connect the LT-3110 Control Unit to the vessel 12 or 24 VDC power source. DC isolation resistance measured on a disconnected LT-3110 Control Unit between GNDC and VDC (-) > 50 MΩ.

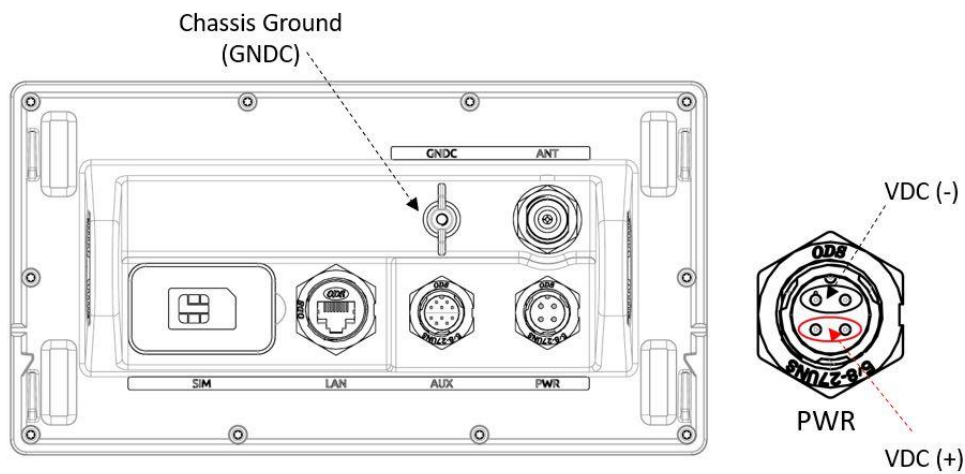

Figure 37: LT-3110 Control Unit (VDC(+), VDC(-), and GNDC)

The LT-3130 Antenna Unit (bottom view) is illustrated in Figure 38. Chassis ground (GNDC) on the LT-3130 Antenna Unit is defined as the mechanics (connected to the mounts).

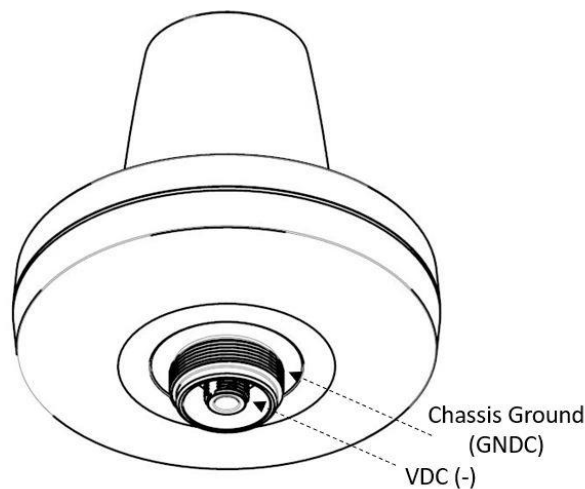

Figure 38: LT-3130 Antenna Unit (VDC(+), VDC(-), and GNDC)

DC isolation resistance measured on a disconnected LT-3130 Antenna Unit between GNDC and VDC (-) > 50 MΩ. VDC (-) and VDC (+) is respectfully the N connector thread and the N connector center conductor. Figure 39 is illustrating the LT-3100 system consisting of LT-3110 Control Unit, LT-3130 Antenna Unit, and the coaxial cable connecting these two units.

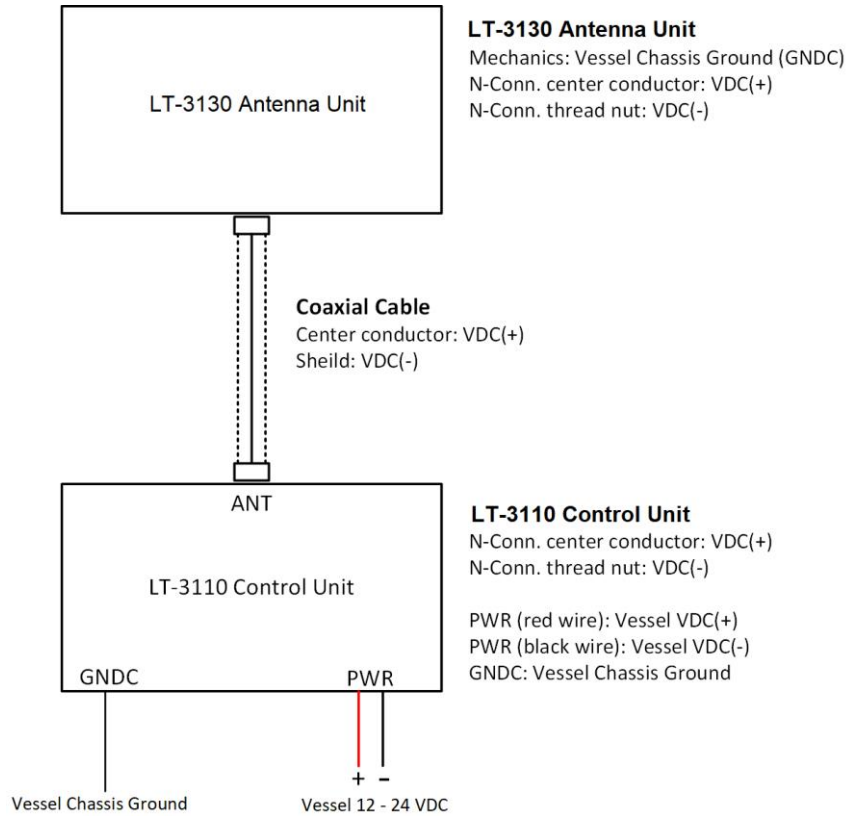

Figure 39: Definitions of VDC (+), VDC (-), and GNDC

It is important that the coaxial cable, connected to both the LT-3110 Control Unit and LT-3130 Antenna Unit, is not grounded in any of the ends. Do not connect the coaxial cable shield to vessel ground. The coaxial cable N connector must only be connected directly to the N connector of the two units.

NOTE: Make sure that the LT-3130 Antenna Unit is connected sufficiently to vessel ground. Also, make sure that the N connector on the LT-3130 Antenna Unit, VDC (-) is not connected to the LT-3130 Antenna Unit mechanics, GNDC. It is important to adhere to this requirement so as not to get a bad DC isolation resistance.

Galvanic Isolated Power Supply

Use an IEC 60945 approved AC/DC or DC/DC galvanic isolated power supply for the LT-3100 system. The galvanic isolated power supply must be used to protect the LT-3100.

AC/DC Galvanic Isolated Power Supply

Connection of an AC/DC galvanic isolated power supply is illustrated in Figure 40.

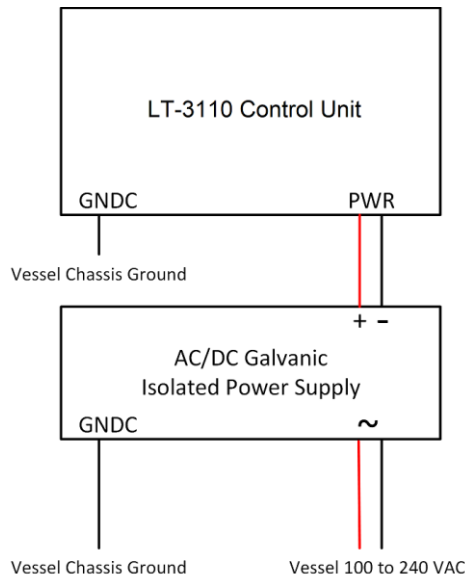

Figure 40: AC/DC Galvanic Isolated Power Supply

DC/DC Galvanic Isolated Power Supply

Connection of a DC/DC galvanic isolated power supply is illustrated in Figure 41.

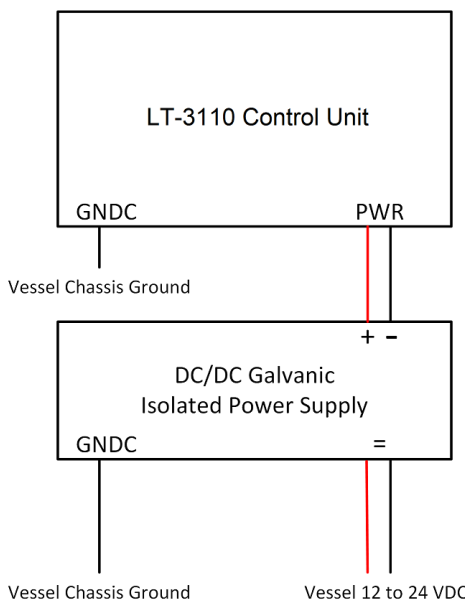

Figure 41: DC/DC Galvanic Isolated Power Supply

User Interface (UI)

The LT-3100 system is controlled from the LT-3110 Control Unit, which is the interface for operating and configuring the system. The control unit has a 4.3" TFT-LCD display, supporting day and night modes. The layout of the display and buttons is illustrated in Figure 42.

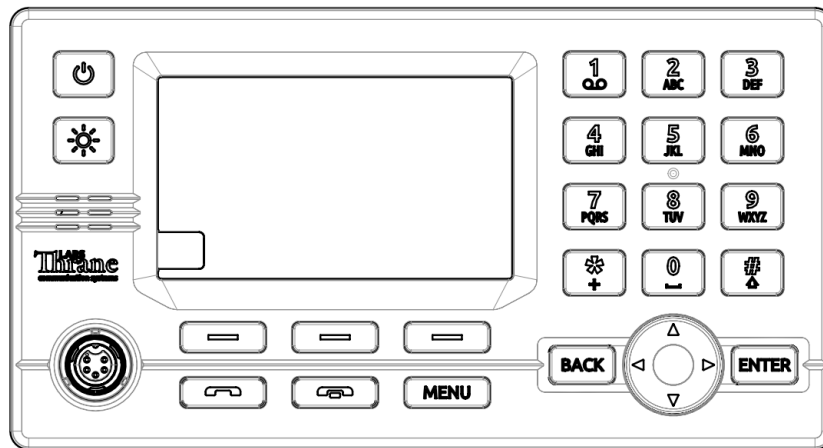

Figure 42: Control Unit (front view) – user interface display and buttons.

The control unit buttons, function and features, are described in the following groups:

- **Power button:** The power button can power off the system by pressing the button for 5 seconds. A pop-up box will show the action, and a counter will count down until the system is powered off. To Turn the system back on press and hold the power button.
- **Brightness button:** The brightness button has two functions – change of brightness level and change of display mode (day and night). When changing the brightness level, the keypad backlight will be changed as well. Short press (< 1 s); brightness level will change between 7 levels. Long press (≥ 1 s); will change display mode. The display brightness level and display mode can be changed from the UI menu as well (Menu -> Settings -> Display).
- **Off-hook button:** The button is illustrated with a green colored handset. The function of the off-hook button is to activate a call, if the dialled number is available in the display or a contact is selected in the Contacts or Call History. The off-hook button can also be used to accept an incoming call. The alternative to use the off-hook button is to lift the handset out of the cradle. If the off-hook button is used and the handset remain in the cradle, the phone audio will be available in the control unit speaker. The microphone is muted, if the handset remains in the cradle - indicated with an icon in the status bar.
- **On-hook button:** The button is illustrated with a red colored handset. Pressing the on-hook button will terminate an active call.
- **MENU / BAM button:** The MENU button is used to open the main menu. The BACK, Navigation (arrows), and ENTER buttons are used to navigate in the menu. Press the MENU button to exit the menu from anywhere in the menu tree (instead of multiple BACK button presses). Long press (> 1 s) the MENU / BAM button and the BAM Alert List will be shown.
- **Soft keys buttons:** Three soft keys are available in the bottom of the display. The soft keys are used for different purposes and their functions will change in the operation modes of the system.
- **Navigation buttons:** The navigation buttons (BACK, arrows, and ENTER) are used for navigation purposes in the menu layout. In context of user input or when making selections, the BACK button will erase input or cancel editing respectfully, the ENTER button will end input or apply selection

respectfully. The arrow buttons can be used to change brightness level if the brightness button has activated the brightness bar.

- Numeric Keypad buttons:** The numeric keypad buttons, the '*' button, and the '+' button can be used for entering digits, letters and special characters. Depending on context, pressing one button in rapid succession (< 1s) will cycle through a selection of letters, digits and/or special characters (e.g. when entering a phone number, pressing the '*' character twice in succession will result in one '+' character and not two '*' characters). An icon in the status bar will show the current input mode, indicating which characters can be cycled - if any. In text mode, the '#' key is used to change between capital and lowercase letters.

Display

The display contains three sections as illustrated in Figure 43: Status bar, view area and soft keys.



Figure 43: LT-3110 Control Unit - UI display sections

The essential system status and system notifications are shown in the status bar, which is always present.

The view area contains the active view. The active view is changed by navigating the UI using the MENU and navigation buttons. The text and function of the soft keys changes dynamically with the active view. The soft keys can also change without changing view depending on the activity in the active view.

The Recommended viewing distance is 68 cm, at which all data is readable under all light conditions.

The general level of the brightness can be varied through 7 steps from 5 cd/m² up to 560 cd/m² on white background in “Day mode”. The display also has a “Night mode” (inverted graphics) with additional 7 steps.

It has been verified through measurements that dense text information areas on black background emits light equivalent to 1 cd/m². All measurements through all light levels in the two modes demonstrates a minimum contrast level of 350:1.

The status bar has a dedicated section for presenting time and position and 7 slots for system status icons.

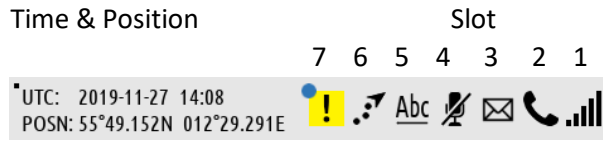

Figure 44: LT-3110 Control Unit - UI (status bar)

NOTE: The status bar contains a flashing square in the upper left corner to verify that the display never freezes, see Figure 44 on page 44. The flashing square is always visible on the display.

Each slot shows the status of one function or group of functions. If a group of functions in a slot has more than one active icon, the slot will continuously take turn showing one icon at a time for a few seconds before cycling to the icon of the next function.

Network Status – Slot 1	
	The LT-3100 system has no satellite signal and is not registered on the Iridium® Network.
	The LT-3100 system has satellite signal = 0 and is registered on the Iridium® Network.
	The LT-3100 system has satellite signal = 1 and registered on the Iridium® Network.
	The LT-3100 system has satellite signal = 5 and registered on the Iridium® Network.
	The LT-3100 system has satellite signal = 5 and unregistered on the Iridium® Network.

Table 10: LT-3110 Control Unit - UI network status





Iridium Service – Slot 2	
	Active voice call or off-hook mode.
	An external (SIP) phone is in an active voice call.
	Voice service unavailable due to an unspecified error
	There is an active data connection.
	Data service unavailable due to an unspecified error

Table 11: LT-3110 Control Unit - UI Iridium service



Notifications – Slot 3	
	There are one or more missed calls.
	There are one or more voicemail messages.
	There are one or more unread SMS or Email messages.

Table 13: LT-3110 Control Unit - UI notifications

Audio – Slot 4	
	The microphone on the handset is muted.

Table 12: LT-3110 Control Unit - UI audio





Input Mode – Slot 5	
	The numeric keypad can be used to enter a phone number or numeric number.
	The numeric keypad can be used to enter text. The first letter of a sentence will be in upper case.
	The numeric keypad can be used to enter text. All letters will be in lower case.
	The numeric keypad can be used to enter text. All letters will be in upper case.

Table 14: LT-3110 Control Unit - UI input mode



Miscellaneous Functions – Slot 6	
	A Bluetooth device is connected.
	The Tracking service is active.

Table 15: LT-3110 Control Unit - UI miscellaneous functions







BAM Status - Slot 7	
	Active - unacknowledged warning
	Active - silenced warning
	Active - acknowledged warning
	Active - responsibility transferred warning
	Rectified - unacknowledged warning
	Active caution

Table 16: LT-3110 Control Unit - status bar (BAM status)

Menu System

The LT-3100 system’s main menu is accessed by pressing the MENU button on the keypad. The user will be presented with a layout as illustrated in Figure 45.

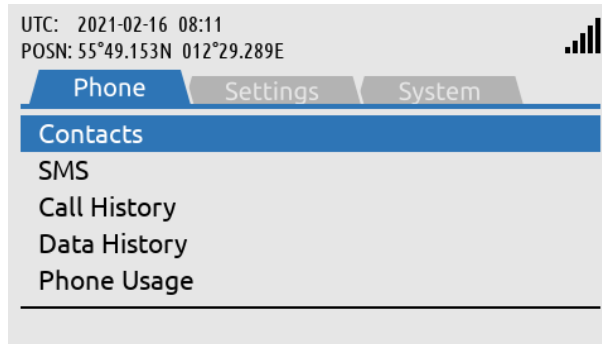

Figure 45: LT-3110 Control Unit - UI display (main menu).

The main menu is represented by three sub-menus: Phone, Settings, and System. The three sub-menus are listed in Table 17.

Sub-menus	Entries
Phone	Contacts SMS Call History Data History Phone Usage
Settings	Audio Display Date & Time Phone Setup Bluetooth Security Reset Options
System	BAM Alerts Network Tracking SIP Phones GNSS Status System Info Power Supply

Table 17: LT-3110 Control Unit, sub-menu layout.

The main menu is represented by three submenus: Phone, Settings, and System. The three submenus are listed in Table 17.

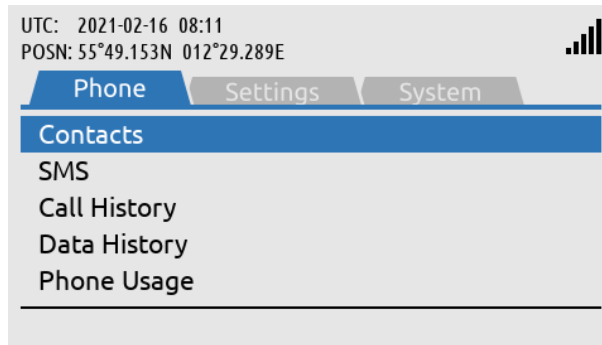

Phone submenu:
MENU -> Phone

Figure 46: Phone submenu

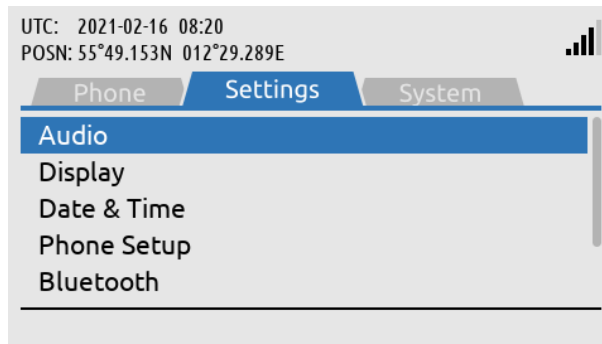

Settings submenu:
MENU -> Settings

Figure 47: Settings submenu

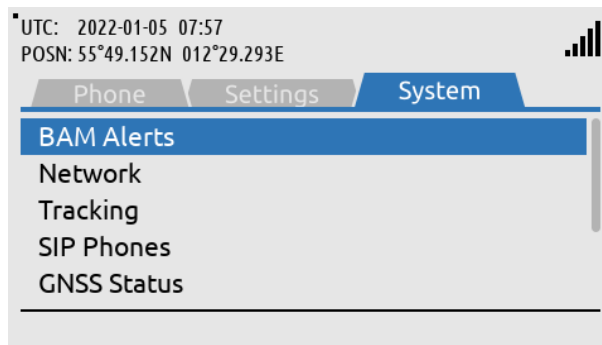

System submenu:
MENU -> System

Figure 48: System submenu

Activating the System

A few things must be completed before you can have an operational LT-3100 system on board your vessel. It is assumed that you have received the LT-3100 system from the Lars Thrane A/S certified partner - this could be directly or indirectly. The Lars Thrane A/S certified partners have completed technical training and will be able to assist you with all the questions you might have to the product or service. The Lars Thrane A/S certified partners are listed on the company's website: <https://www.thrane.eu>

The following is required for activating the LT-3100 system:

- SIM card

The LT-3100 system installation and mounting is described in the previous sections.

IMPORTANT: In order for the LT-3100 system to be deemed operational and ready for continuous service: i) it must be correctly installed per the specifications in the User & Installation Manual of the LT-3100 Satellite Communications System ("LT-3100 User & Installation Manual"), ii) the Iridium SIM card, which serves to evidence that a terminal has been subscribed to Iridium's Network, has been secured and correctly installed. The Iridium SIM card is at all times required for operation of the equipment and is a critical and indispensable part of the LT-3100 system. Without a valid Iridium SIM card correctly installed and continuously maintained in the inserted position in the LT-3110 Control Unit, pursuant to the instructions in the LT-3100 User & Installation Manual, the terminal is not operational and not ready and available for continuous use on any vessel.

Acquire a SIM Card

An Iridium SIM card must be used for activating a LT-3100 system. The SIM card is described and illustrated in *SIM card (SIM)* on page 29. The SIM card may be acquired directly from your Lars Thrane A/S certified partner. The SIM card must be inserted in the LT-3110 Control Unit before powering up the system.

Who's My Service Provider

Iridium has a website where they inform about the specific Service Provider (SP) who has activated the LT-3100 system (or any other Iridium activated product).

Use the following link: <https://www.iridium.com/who-is-my-sp/>

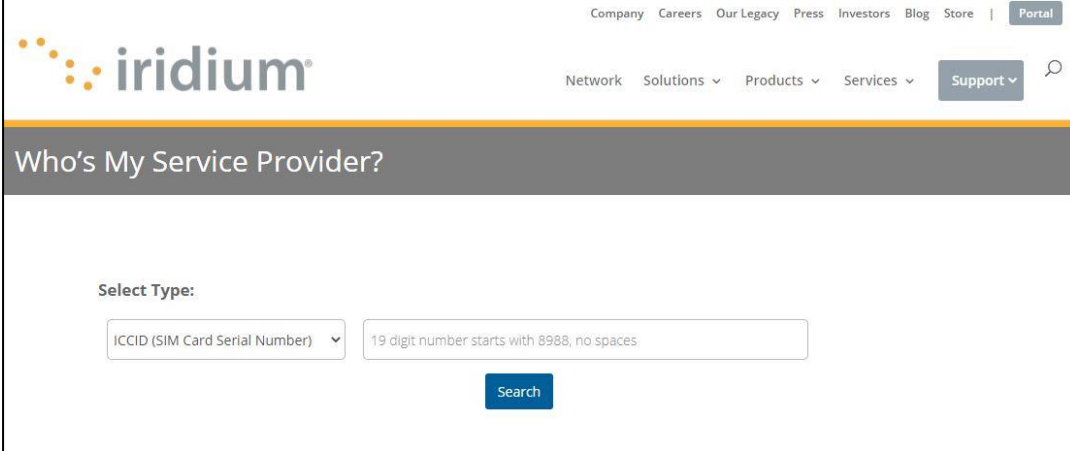

The screenshot shows the Iridium website's 'Who's My Service Provider' page. At the top, there is a navigation bar with links for Company, Careers, Our Legacy, Press, Investors, Blog, Store, and Portal. Below this, the Iridium logo is on the left, and a secondary navigation bar includes Network, Solutions, Products, Services, and Support. The main heading is 'Who's My Service Provider?'. The form below has a 'Select Type:' label, a dropdown menu currently showing 'ICCID (SIM Card Serial Number)', and a text input field with a placeholder '19 digit number starts with 8988, no spaces'. A blue 'Search' button is located below the input field.

Figure 49: Iridium - Who's My Service Provider

You can use the following information:

- ICCID (SIM card serial number)
- MSISDN (Mobile Subscriber ISDN number)

NOTE: The Iridium Service Provider (SP) must be contacted for any changes to the provisioning. 'Who's My Service Provider' will inform you where your LT-3100 system is provisioned.

Change of Hardware and Software

Change of Hardware

This section will provide some guidance on replacing system units and what the user of the LT-3100 system should be aware of, see Table 18.

Change of Hardware		
Hardware	Procedure	Comments
LT-3110 Control Unit	The LT-3110 CU can be replaced by swapping the hardware . Remember the SIM card from the 'old' LT-3110 CU.	All user data (contacts, call history, and SMS) will be lost, since the LT-3110 CU is the 'master' of the system.
LT-3120 Handset	Change hardware.	Test the new hardware.
LT-3121 Cradle		
LT-3130 Antenna Unit		
SIM Card	The SIM card can be replaced with a new SIM card, but the Iridium Service Provider must be involved. The ICCID number of the new SIM card must be updated on the provisioning before the new SIM card is inserted in the LT-3110 CU and the system is powered up	Only an Iridium SIM card can be used in the LT-3100 system.

Table 18: Change of Hardware in the LT-3100 system

Always remove the DC input power to the LT-3100 system when changing the hardware and system units.

NOTE: Changing the LT-3130 Antenna Unit or the SIM card requires involving of the Iridium Service Provider (SP) and provisioning. For details of the Iridium Service Provider (ISP), see *Activating the System* on page 49.

Software Update

The LT-3100 system must be software updated by using the web server, see *Maintenance, Software update* on page 130. Accessing the web server is described in *Accessing the built-in web server* on page 101. The software update procedure will automatically update all system units connected to the LT-3110 Control Unit. The Lars Thrane Image (LTI-file) e.g. LT-3100-v1.13R-00XX.Iti will include all software components to all system units. All system units connected to the LT-3110 Control Unit will be upgraded or downgraded to be aligned with the LT-3110 Control Unit, which is the 'master' of the system. As soon as the software update procedure is started, the LT-3110 Control Unit window will indicate 'Software update in progress' as illustrated in Figure 50.

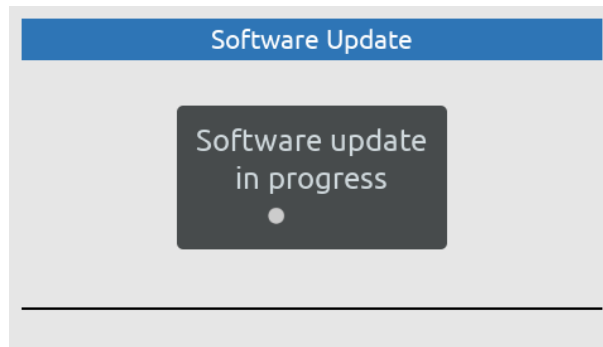

Figure 50: Software update

Once, the LT-3100 system has finalized the software update, the system will reboot.

NOTE: Please check the Lars Thrane A/S company website for newest available software for the LT-3100 system.

System Services

Voice call

The LT-3100 system supports Voice call outgoing and incoming from phone numbers (incl. Satcom). Every voice call will generate a record in the Call History placed in the Phone submenu (MENU -> Phone -> Call History), see *Phone* on page 77.

NOTE: Verify that the LT-3100 system is ready to make or receive a voice call. Check the network registration status, as illustrated in Table 10 on page 44 (Network Status - Slot 1), which is presenting the signal level and network registration status.

NOTE: Always, make sure to have a LT-3120 Handset and LT-3121 Cradle properly installed and connected to the LT-3110 Control Unit. The LT-3110 Control Unit handset connector is illustrated in *Figure 2* on page 6. The LT-3100 system will generate a BAM alert, if the LT-3120 Handset is not connected to the LT-3110 Control Unit (Lost handset).

NOTE: The LT-3100 system is supporting connection of external SIP phones. The connection of external SIP phones is described in *External SIP Phones* on page 65.

The LT-3100 system is supporting Mobile Originated (MO) outgoing and Mobile Terminated (MT) incoming voice calls. The following sub sections will describe and illustrate the outgoing and incoming voice calls.

Mobile Originated (MO) - Outgoing

An outgoing voice call can be established as described in Table 19.

Mode	Position of Handset	Description
on-hook	Handset placed in cradle until voice established	Type the number and use the off-hook button.
		Use the off-hook button and select the soft key 'Contacts' or 'Call History'. Select the entry and use the off-hook button to initiate the voice call.
		Navigate to Contacts or Call History by using the MENU button (MENU -> Phone -> Contacts or Call History) and use the off-hook button when the entry has been selected. The voice call will now be established.
off-hook	Handset lifted out of cradle initially	Lift the handset out of the cradle (ready tone is available). Type the number and wait 10 seconds or use the # key to initiate the voice call.

Table 19: Initiate Mobile Originated (MO) Voice Call

The voice call (on-hook and off-hook mode) will be described and illustrated on the following pages.

On-hook mode:

In on-hook mode the user can either type in the number directly in the display or use the Contacts or Call History to identify the number to be called while the handset is still placed in the cradle. Once the voice call has been established (duration starts to count) the user can lift the handset out of the cradle. The example in this section shows how to use the off-hook button, identifying an entry in the Contacts, and initiate the voice call by pressing the off-hook button.

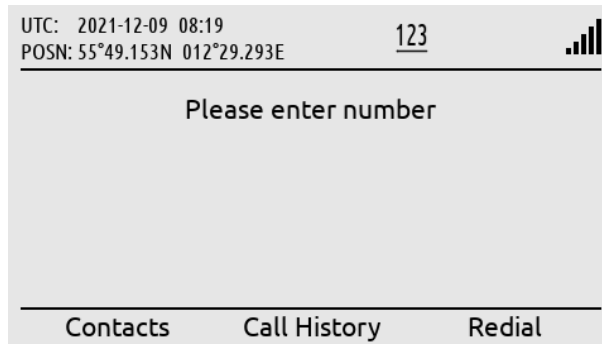

Press the off-hook button (colored green) on the LT-3110 Control Unit. Hereafter press the soft key 'Contacts'.

Figure 51: Outgoing Voice Call, on-hook mode (1 of 5)

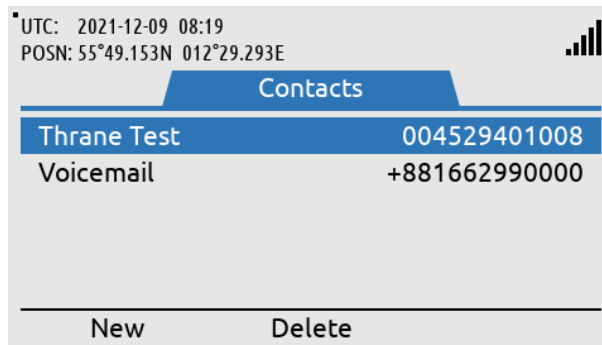

Use the Navigation key and select the contact to be dialed. Press the off-hook button to start connecting the call.

Figure 52: Outgoing Voice Call, on-hook mode (2 of 5)



The LT-3100 system is connecting a voice call to the contact 'Thrane Test' (004529401008).

Figure 53: Outgoing Voice Call, on-hook mode (3 of 5)

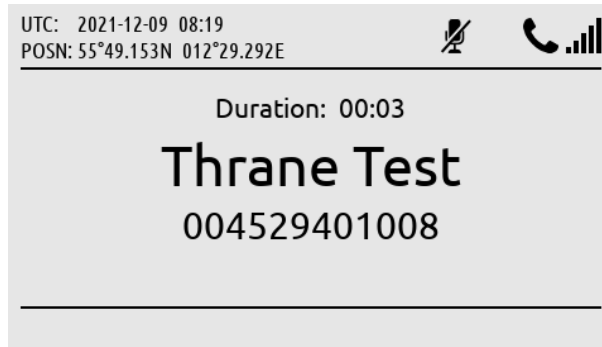

The LT-3100 system has established a voice call to 'Thrane Test' (Duration: 00:03).

Figure 54: Outgoing Voice Call, on-hook mode (4 of 5)



The voice call can be terminated by placing the handset in the cradle or use the on-hook button (colored red).

Figure 55: Outgoing Voice Call, on-hook mode (5 of 5)

The mute symbol illustrated in Figure 54 in the status bar will disappear as soon as the handset is lifted out of the cradle. The handset will always be muted when placed in the cradle. The voice from the connected party will be available in the LT-3110 Control Unit speaker, until the handset is lifted out of the cradle. It is always possible to mute and unmute the microphone in the handset from the LT-3110 Control Unit (soft key 'Mute' and 'Unmute') when having an active call and the handset is lifted out of the cradle.

NOTE: Adding a new entry in the Contacts (MENU -> Phone -> Contacts) is described and illustrated in *Phone* on page 77.

Off-hook mode:

The off-hook mode can be activated by lifting the handset out of the cradle. In off-hook mode, the user will be met by a *ready tone* and the help text “Please enter number” - hereafter, the called number can be entered, using the numeric keypad. It is not possible to regret, if one or more wrong digits are typed in for the dialed number. In this case, the user must on-hook the phone, and dial the correct number again. The example below shows how to establish the voice call (the other part of the voice call is identical to the on-hook mode described in the previous section).

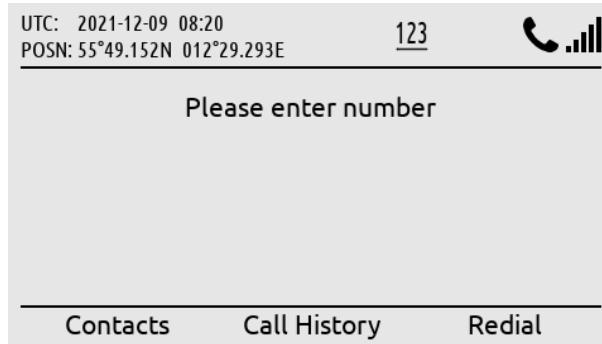

Lift the handset out of the cradle and a ‘ready tone’ will be available in the handset speaker.

Figure 56: Outgoing Voice Call, off-hook mode (1 of 3)

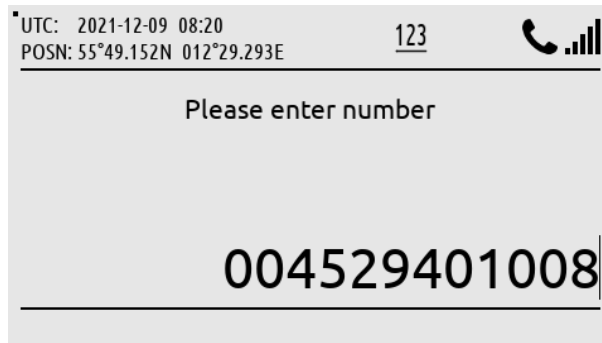

Type the number in the display by using the numeric keypad (it is not possible to regret).

Figure 57: Outgoing Voice Call, off-hook mode (2 of 3)



Use the off-hook button, # key, or wait 10 seconds for the LT-3100 system to start connecting the voice call.

Figure 58: Outgoing Voice Call, off-hook mode (3 of 3)

NOTE: The LT-3100 system will provide the user with information, while connecting and throughout the voice call. In case of problems with the satellite network or connection to the called party (far-end), the user will be informed through a voice prompt, and by status cause codes, that will be presented on the display (e.g. “Temporary link failure”).

Mobile Terminating (MT) - Incoming

The LT-3100 system supports receiving an incoming voice call. The calling party must use the LT- system MSISDN number. The LT-3100 system will check the calling number up against the Contacts entries, if a match exists, the name of the contact will be showed for the incoming voice call.



Incoming voice call available in the LT-3100 system.

Figure 59: Incoming Voice Call (1 of 3)

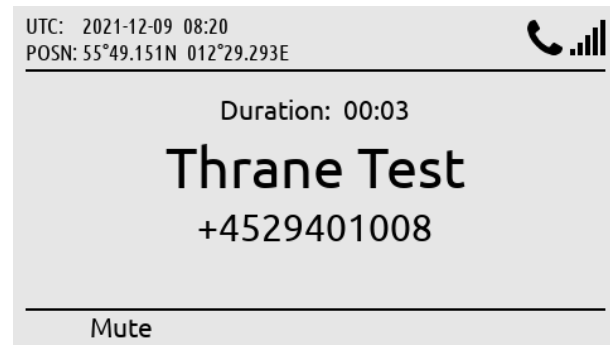

The handset has been lifted out of the cradle and the voice call is established.

Figure 60: Incoming Voice Call (2 of 3)

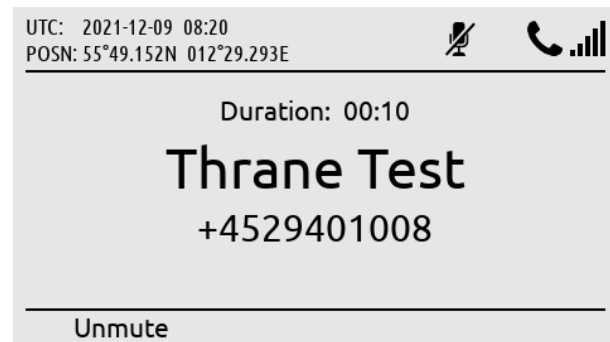

The voice call can be muted. To mute/unmute the handset microphone during a voice call, use the soft key 'Mute' and 'Unmute'.

Figure 61: Incoming Voice Call (3 of 3)

An incoming missed voice call is illustrated in the following figures: Figure 62 to Figure 64. By pressing the soft key 'Missed Calls(1)' the user will be redirected to the Call History (filter: Missed Calls). By pressing the soft key 'Show All', all Call History records will be shown (all incoming and outgoing calls).

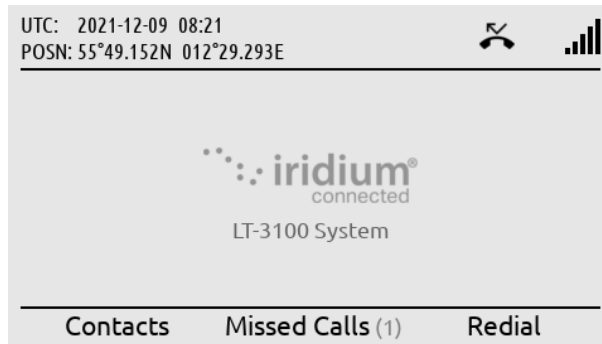

A missed voice call is illustrated in the display (symbol in status bar and soft key showing 'Missed Calls(1)').

Figure 62: Incoming Voice Call, missed (1 of 3)

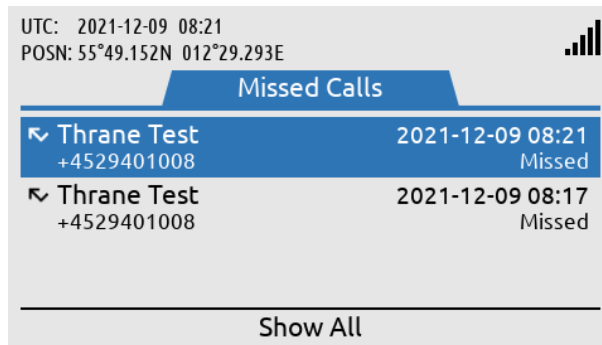

By pressing the soft key 'Missed Calls(1)' the user will be directed to the Call History (Missed Calls).

Figure 63: Incoming Voice Call, missed (2 of 3)

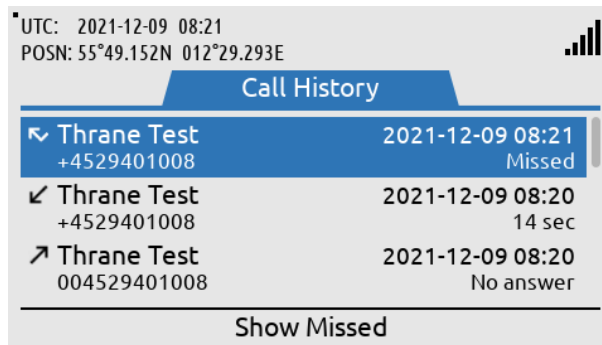

Press the soft key 'Show All' and the normal view of the Call History will be shown.

Figure 64: Incoming Voice Call, missed (3 of 3)

NOTE: An incoming missed voice call is illustrated in the above figures. By highlighting the missed call in the Call History and press the off-hook button, the LT-3100 system will start establishing a voice call to the party.

SMS

The LT-3100 system supports Short Message Service (SMS) sending and receiving from traditionally phone numbers (incl. Satcom) and Email addresses.

The LT-3100 system supports sending and receiving concatenating SMS (SMS' consisting of multiple instances). A standard SMS (single instance) is consisting of 160 characters. A concatenated SMS sent from the LT-3100 system is delivered as individual SMS' (error in the network). A concatenated SMS received in the LT-3100 system is received and displayed correctly.

Sending an Email from the LT-3100 system is handled similar to sending a SMS, To insert the Email address in the 'To:' field use the # key to toggle between numbers and letters. If sending an Email to the LT-3100 system, then leave the Subject-field empty. Please note that all text larger than an SMS (160 characters) is truncated and that the length of the Email address + one character is deducted from the payload text. When sending an Email to the LT-3100 system, then the MSISDN number must be used (e.g. 88163XXXXXX@msg.iridium.com). Don't use international prefix ('+' or '00' in front of the MSISDN number).

The SMS Service is located in the Phone submenu (MENU -> Phone -> SMS), as illustrated in Figure 65.

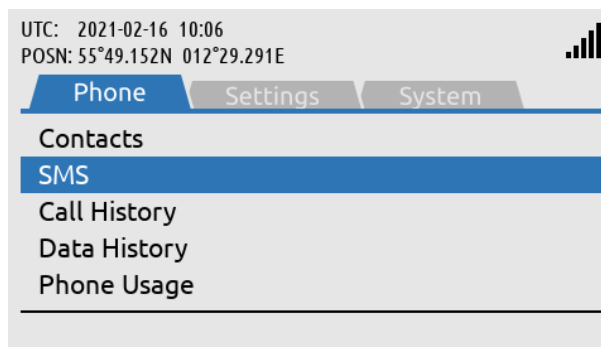

General Messaging (~SMS):
MENU -> Phone -> SMS

Figure 65: Phone submenu (General Messaging ~SMS)

NOTE: The LT-3100 system support SMS sending and receiving from traditionally phone numbers (incl. Satcom) and Email addresses.

NOTE: The LT-3100 system can store minimum 500 SMS' in total (sent and received). An individual SMS or SMS conversations can be deleted from the SMS window. To delete all SMS' at once, navigate to the Settings submenu (MENU -> Settings -> Reset Options: Delete SMS Messages).

Sending SMS

To send a SMS, the user of the LT-3100 system must access the Phone submenu (MENU -> Phone -> SMS). In the SMS window all sent and received SMS are visible. In Figure 66 the SMS window is illustrated with 'No Messages'. Press the soft key 'New' to prepare a new SMS. It is possible to reply to an existing conversation (phoner number, Email address) when entries are available. Figure 66 to Figure 72 illustrates sending a new SMS (to a normal phone number).

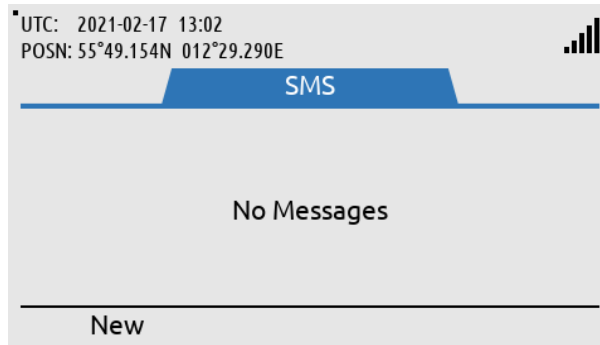

No SMS' are available in the LT-3100 system (sent or received). Use soft 'New' to prepare a new SMS.

Figure 66: Sending SMS (1 of 7)

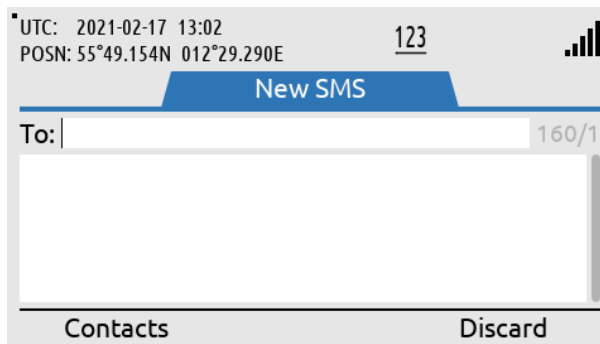

Use soft key 'Contacts' or enter the number directly in the To-field.

Figure 67: Sending SMS (2 of 7)

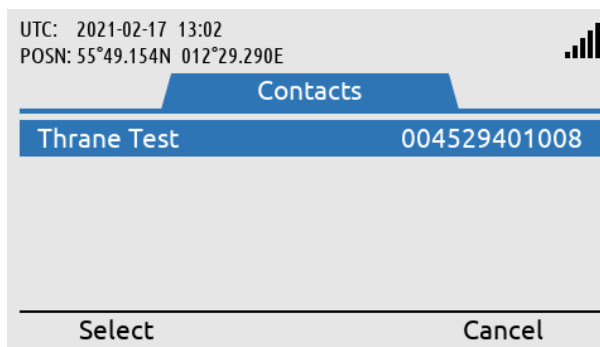

If Contacts has been chosen, then select the contact by using the Navigation key and the soft key 'Select'.

Figure 68: Sending SMS (3 of 7)

NOTE: If the Contact has a Phone Number and an Email address the user will need to choose between the two for the message destination.

Press the soft key 'Send' when the destination address and body text have been completed. The SMS service will indicate the transmitting status, which will change from 'Sending' to 'Sent' when the SMS has successfully been sent from the LT-3100 system, see Figure 71 and Figure 72.

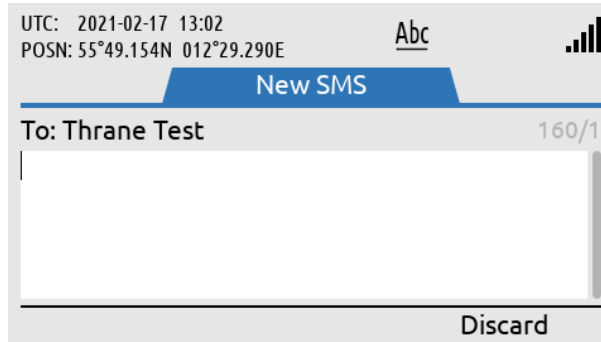

Write the SMS text.

Figure 69: Sending SMS (4 of 7)

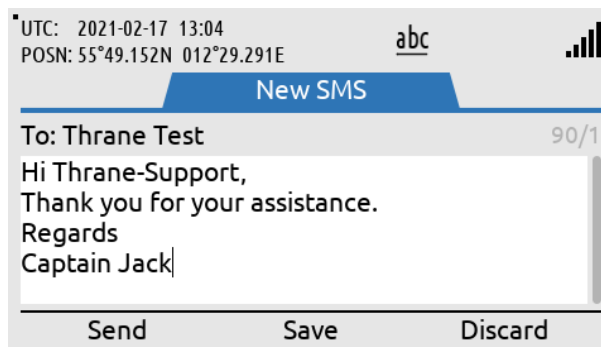

When the SMS is ready to be sent use the soft key 'Send'.

Figure 70: Sending SMS (5 of 7)

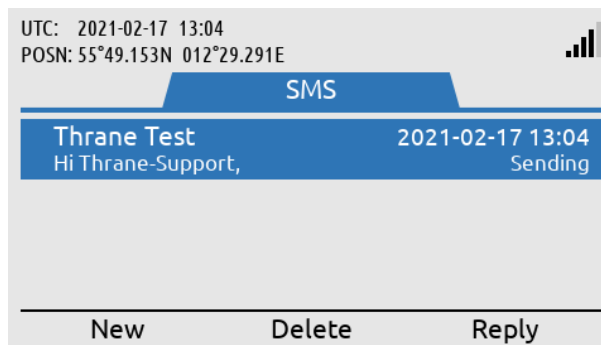

The SMS will change status from Sending to Sent when the SMS has successfully been sent.

Figure 71: Sending SMS (6 of 7)

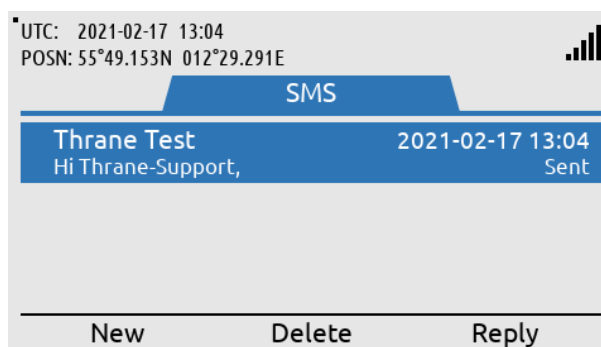

The SMS has successfully been sent. Otherwise, retry option is available.

Figure 72: Sending SMS (7 of 7)

NOTE: If sending the SMS is failing (the SMS window will indicate 'Failed'), then a 'Resend' soft key will be available for the user to make another try. A successful SMS sending will be indicated by 'Sent' - this information will be replaced by 'Now' and hereafter the time since the SMS was successfully sent (e.g. '19 hours ago' and so forth).

Receiving SMS

A received SMS will be indicated by the unread symbol in the status bar, a notification tone, and the soft key 'SMS(1)' will be shown as illustrated in Figure 73.

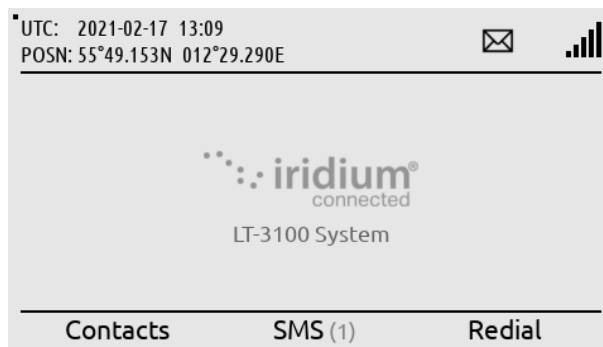

The LT-3100 system has received a SMS, see symbol in status bar and soft key 'SMS(1)'.

Figure 73: Receiving SMS (1 of 3)

To read the incoming SMS, press the softkey 'SMS(1)' or navigate to the Phone submenu (MENU -> Phone -> SMS). The unread symbol will be removed as soon as the SMS has been read. Open the individual SMS or SMS conversation by pressing the ENTER button. Use the soft key 'Reply' to reply to a sent or received SMS.

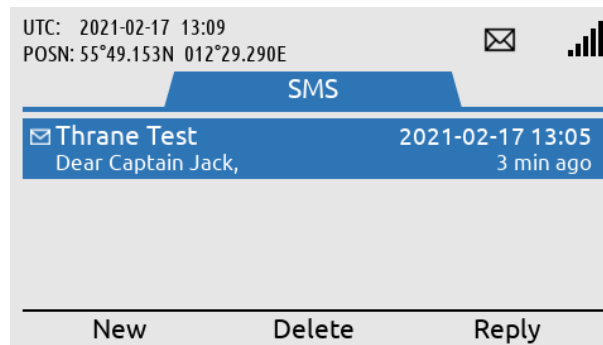

Press the soft key 'SMS(1)' and the user will be directed to the SMS window.

Figure 74: Receiving SMS (2 of 3)

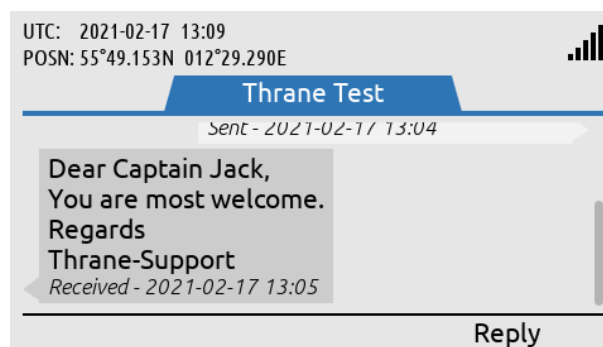

Use the ENTER button to open the received SMS.

Figure 75: Receiving SMS (3 of 3)

NOTE: The LT-3100 system is handling SMS conversions, which is grouped based on the recipient's address.

NOTE: SMS and Email can also be sent from the Web Server, see *Web server, Messages* on page 103.

External SIP Phones

The LT-3100 system is supporting connection of external SIP phones, up to 8 external SIP phones. The configuration of the SIP phones must be completed via the web server, see *Telephony* on page 115. Figure 76 is illustrating the connection of the external SIP phones. Connect the SIP phones directly to the LT-3110 Control Unit Ethernet (LAN port).

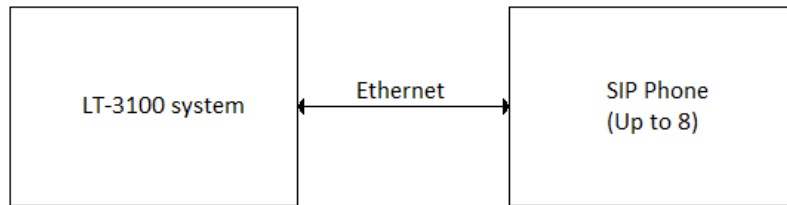
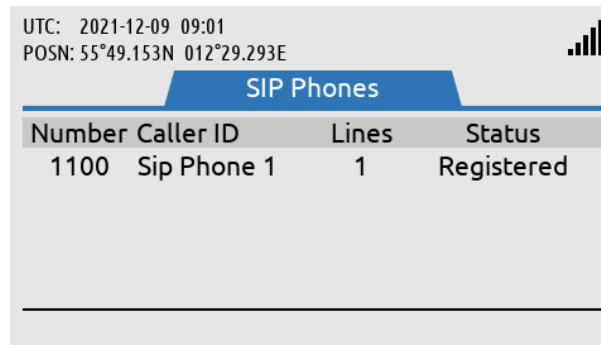

Figure 76: SIP phones

NOTE: The SIP phone might require a DHCP Server to get an IP address assigned. Depending on network setup, it might be needed to configure DHCP Server mode in the LT-3100 system.

The LT-3110 Control Unit UI display (MENU -> System -> SIP Phones) will provide a ‘live’ registration status of the SIP phones configured from the web server.



SIP Phones:
MENU -> System -> SIP Phones

Figure 77: System Submenu (SIP Phones)

An active voice call to/from a SIP phone will be presented in the Status bar with the symbol showed in Figure 78.

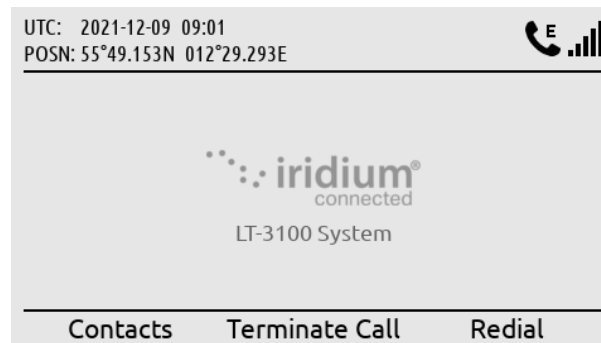

External SIP voice call is using the satellite connection. Can be terminated by using the soft key ‘Terminate Call’.

Figure 78: External SIP Voice Call

By using the soft key 'Terminate Call', the external voice call from the SIP phone will be terminated.

An incoming voice call taken by the SIP phone cannot be forwarded. Once a voice call has been taken by any of the 'lines' the voice call is locked to this user.

The LT-3100 system is supporting local calling between the SIP phones and the LT-3120 Handset. The number plan is illustrated in Table 20. The Caller ID is defined by the user, when configuring the SIP phones.

LT-3100 system Number Plan (local calls)		
Number	Caller ID	Comments
1000	LT-3100 User	LT-3120 Handset
1100	SIP Phone 1	
1101	SIP Phone 2	
1102	SIP Phone 3	
1103	SIP Phone 4	
1104	SIP Phone 5	
1105	SIP Phone 6	
1106	SIP Phone 7	
1107	SIP Phone 8	

Table 20: Number Plan (local calls)

NOTE: The LT-3100 system is only supporting one outgoing satellite voice connection. A local call between two local users will not busy the Satellite voice connection.

Analogue Phone Adapter

The LT-3100 system is supporting connection of an external Analogue Phone Adapter (e.g. Grandstream). The number of POTS' phones (Plain Old Telephone System), which can be connected to the Analogue Phone Adapter, must be configured as SIP phones in the LT-3100 system, see configuration of SIP phones in *Telephony* on page 115. Connect the SIP phones directly to the LT-3110 Control Unit Ethernet (LAN port).

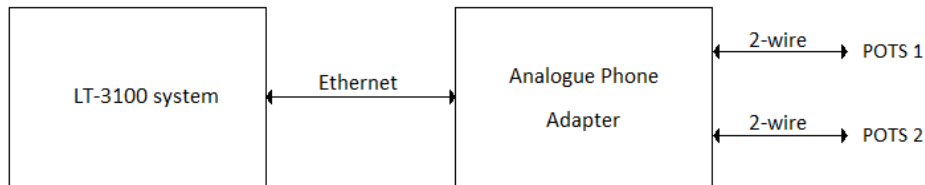

Figure 79: Analogue Phone Adapter

NOTE: The Analogue Phone Adapter might require a DHCP Server to get an IP address assigned. Depending on network setup, it might be needed to configure DHCP Server mode in the LT-3100 system.

The Analogue Phone Adapter (POTS phones) will be handled as SIP phones in the LT-3100 system. Therefore, carefully read the section describing the SIP phones in *External SIP Phones* on page 65.

In order to provide some guidance for configuration of an Analogue Phone Adapter, the following description will outline some important steps for configuring an Analogue Phone Adapter.

Configuration of Grandstream HT802 Adapter (example):

If you would like to connect the Analogue Phone Adapter directly to the LT-3100 system, then it might help you to insert a passive switch between the LT-3100 system and the Analogue Phone Adapter, while completing the setup (to allow for an extra LAN port during configuration).

- Step 1: Connect the LT-3100 system, Analogue Phone Adapter, and PC using a passive switch
- Step 2: Login to the LT-3100 system web server. The IP address can be read from the display (MENU -> System -> Network: IP address)
- Step 3: Configure the LT-3100 system to 'DHCP Server' mode (depending on network setup) and configure the SIP phones (Password, and Caller ID)
- Step 4: The Analogue Phone Adapter will now have an IP address assigned. Connect a POTS phone to the Analogue Phone Adapter and use the IVR menu to read out the IP address (off hook handset and type '***' followed by '02'). Check the instructions provided for the Analogue Phone Adapter
- Step 5: Log in to the Analogue Phone Adapter and configure FXS PORT 1 and PORT 2 (Primary SIP Server, SIP User ID, Authenticate ID, Password, and Name)
- Step 6: The POTS phones should now be registered and ready to use (the passive switch can be removed)

Data (Modem Data, SMS and SBD)

The LT-3100 System is supporting a serial asynchronous automatic dialing and control interface (V250). The interface makes it possible for external equipment (DTE) to use the Iridium 2.4 kbps Modem Data (Direct Internet, RUDICS and SBD) service. Also, the Iridium SMS service is available over this serial interface.

The Modem Data ‘Direct Internet’ service is used for Dial-up Networking, whereas the Modem Data ‘RUDICS’ service is commonly used for Iridium Service Providers e.g. to support Email programs.

The LT-3110 Control Unit offers a virtual serial RS-232 interface (DCE) supporting data, control, and status signals. The serial interface is based on the Telnet Com Port Control Option network protocol (RFC 2217) and is available at the Ethernet (LAN) interface (RJ45 connector).

Access to the serial interface from a PC requires a virtual COM (or tty) port driver supporting RFC 2217 e.g., the Serial Port Redirector (from Fabulatech) on Windows and ttynvt on Mac and Linux. The virtual COM (or tty) port might be used directly by applications running on the PC (e.g., Email applications) or by the operating system to establish a dial-up connection to the Internet (dial-up networking).

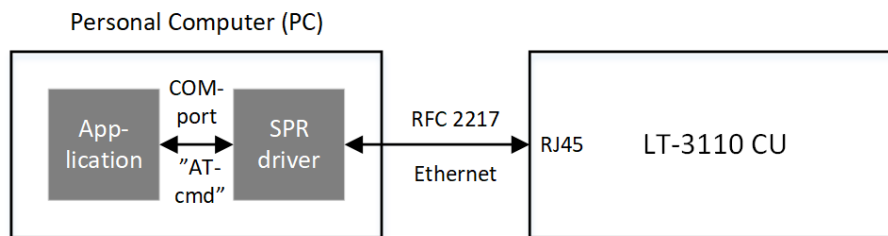

Figure 80: LT-3100 system is supporting RFC 2217 (Serial over Ethernet)

The serial interface can be accessed by connecting to the IP address (port 5020) of the LT-3110 Control Unit. The IP address can be read out from the MENU -> System -> Network, see *System Submenus, System* on page 88. The serial interface is by default disabled and must be activated from the built-in web server, see *Web server, Data* on page 114.

NOTE: The serial interface (port 5020) must be enabled from the LT-3100 System built-in web server to be available by any external application, see *Web server, Data* on page 114. By default, port 5020 is blocked by the built-in LT-3110 Control Unit Firewall.

The LT-3110 Control Unit display will indicate, if the Modem Data service is active by showing the data symbol in the status bar and the soft key 'Terminate Data', see Figure 81.

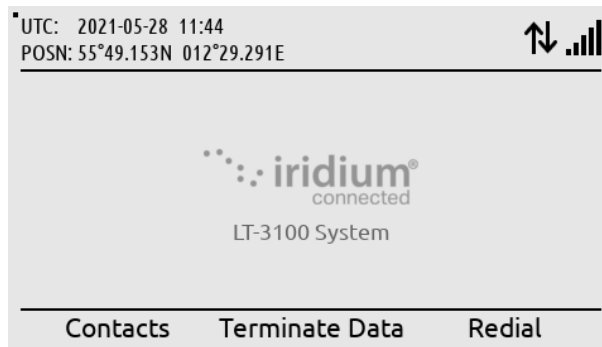

Figure 81: Modem Data service active

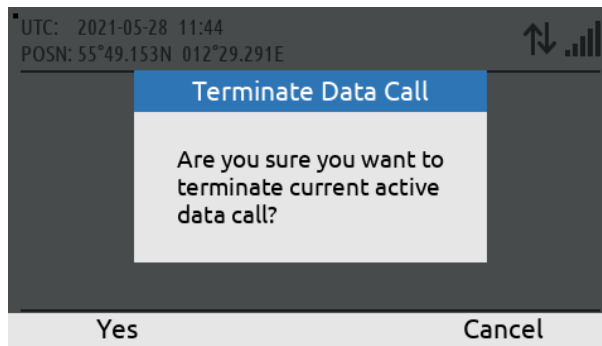

Figure 82: Modem Data service terminate

By pressing the soft key 'Terminate Data' the user of the LT-3100 system can manually terminate the Modem Data connection. The user of the LT-3100 system must confirm the termination of the Modem Data connection by pressing the soft key 'Yes'.

The LT-3100 system is supporting most of the AT-command set supported by the Iridium 9523N module. The Iridium 9523N AT-commands are available in the Iridium document: ISU AT Command Reference.

Modem Data Services & Numbers	
Service	Number
Direct Internet	008816000025
Direct Internet (Russia)	007954107030
RUDICS	Check with Iridium Service Provider or Application

Table 21: Iridium Modem Data Numbers

Installation of the Serial Port Redirector (virtual COM port) and Windows Dial-up Networking is further described in the following Lars Thrane A/S LT-3100 Tech Notes, which can be downloaded from our company website:

- LT-3100 Serial Port Redirector Tech Notes
- LT-3100 Windows Dial-up Networking Tech Notes

IMPORTANT: If the Modem Data service (Direct Internet) Windows Dial-up Networking is established to provide an IP data connection, then it is important to emphasize that no Firewall protection is supported by the LT-3100 system. Firewall rules must be setup and configured in the PC to provide the required protection.

Email programs

External Email programs can be installed on a PC and use the Serial over Ethernet (RFC 2217) e.g., SPR Virtual COM port to establish a Modem Data connection (RUDICS) to a dedicated RUDICS server. Table 22 list several Email programs and companies, which can be used over an Iridium Modem Data (RUDICS) connection. Additional Email programs may be compatible with the LT-3100 system and the Iridium Modem Data service.

External Email Programs	
SkyFile Mail	Marlink
OnSatMail	AST
GTSeaMail	GTMaritime
SpeedMail	SpeedCast
Iridium Mail & Web (RedPort Optimizer)	Pivotel (Global Marine Network)

Table 22: External Email programs

NOTE: It is important to validate the correct Modem Data (RUDICS) Dial-up number with the Iridium Service Provider or the respective company used. Also, make sure that the Modem Data connection is setup with the correct Modem Data service (+CBST - Select Bearer Service Type, default value: 9600 bps V.32). Further details for the AT-command set is available in the Iridium document: ISU AT Command Reference.

Tracking

The LT-3100 system is supporting tracking functionality. The periodic tracking functionality must be configured from the LT-3100 system web server, see Configuration - Tracking in *Tracking* on page 117.

The LT-3100 system is supporting the following tracking formats:

Transport Types & Report Formats	
Transport Type	Report Format
SMS	Thrane (text) Human readable
Email	Thrane (text) Human readable
SBD	Thrane (binary) SIRIUS track (binary)

Table 23: Tracking Transport Types & Report Format

If periodic tracking reports have been configured by the user of the LT-3100 system in the web server, then a tracking symbol will be shown in the status bar of the LT-3110 Control Unit display. Also, this is to inform the user that tracking reports will be sent periodically.

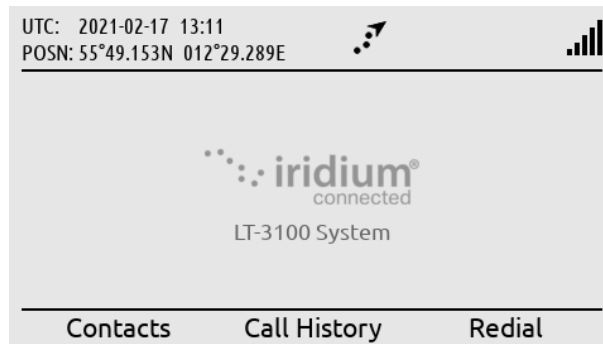

Figure 83: Periodic Tracking Activated

The user of the LT-3100 system can access the Tracking window (MENU -> System -> Tracking) to get some details about the periodic tracking configuration and reports. See Figure 84 on page 72 for the layout of the Tracking window.

The Tracking window shown in Figure 84 illustrates the following periodic tracking configuration:

- Time trigger: Enabled, Timer interval = 12:00 (HH:MM)
- Distance trigger: Enabled, Distance interval = 50.0 (NM), Minimum time interval = 04:00 (HH:MM)

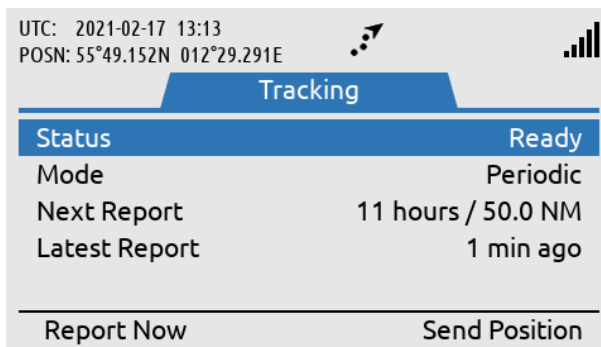

Figure 84: Tracking submenu

Last Report is indicating '1 min ago' because the soft key 'Report Now' button has been used. The soft key 'Report Now' can be used to send additional tracking reports, if tracking has been configured in the web server. Otherwise for this configuration, periodic tracking reports are to be sent every 12 hours / 50 NM (minimum time interval: 4 hours), whatever is first triggered, time or distance.

If Time and/or Distance trigger have been enabled, then Mode is set to Periodic. If none of these trigger conditions have been enabled, then Mode is set to Manual. If the Mode is configured to Manual, then only tracking configuration Options 'Send report on power-on' (configuration parameter from the web server) or the soft key 'Report Now' can activate a tracking report.

If selecting the Last Report using the Navigation key, then you will see the details of this last tracking report sent, as illustrated in Figure 85.

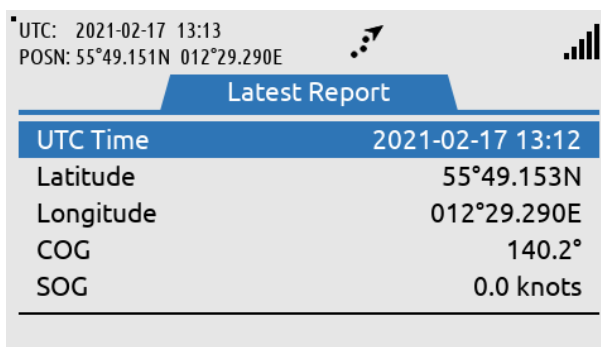

Figure 85: Tracking (Last Report)

NOTE: The LT-3100 system support configuration of periodic tracking reports using different transport types and formats. The periodic tracking reports must be configured using the web server, see Configuration - Tracking in *Tracking* on page 117

Instead of using the periodic tracking report, it is possible without any configuration, to send the vessel position using the Tracking window (MENU -> System -> Tracking). Use the soft key 'Send Position' as illustrated in Figure 84 on page 72.

The LT-3100 system will preformat a position report using the SMS functionality and layout, where the user optionally can select between a regular subscriber number and an Email address. Use the hash '#' key to toggle between numbers and letters in the 'To:' field. It is possible to edit the body text with optional information to the recipient of the vessel position. Whenever the recipient address and body text are completed, use the Navigation key to enter the body text field and the soft key 'Send' will appear. Press the soft key 'Send' and status about transmitting the SMS will be available to the user. The functionality is illustrated in Figure 86 and in Figure 87.

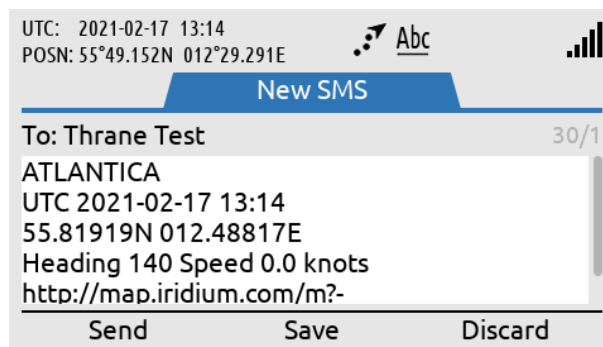

Figure 86: Tracking (Send Position)

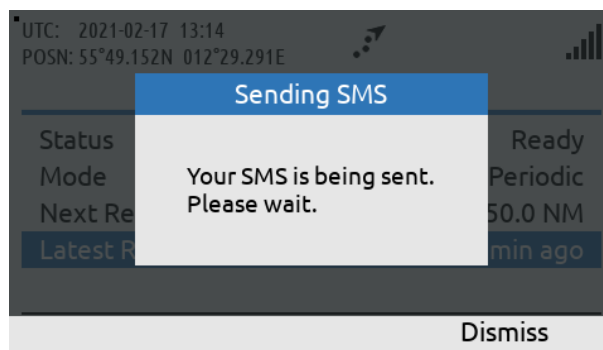

Figure 87: Tracking (Send Position)

NOTE: The LT-3100 system can send a preformatted message detailing the vessel position from the Tracking window without any preceding configuration. Enter the Tracking window (MENU -> System -> Tracking) and press the soft key 'Send' to activate this functionality and select between regular subscriber number and Email recipient address.

Bluetooth

The LT-3100 system offers the user the ability to wirelessly connect equipment to the system using the Bluetooth interface. The Bluetooth feature enables the operator of the system to use the LT-3100 system data connection on their Bluetooth connected equipment. The system currently offers the ability to connect 8 devices simultaneously. The user should consider that connecting 8 devices and accessing data features on all 8 will result in slower data speeds as this divides the LT-3100 download between many devices. Because of this it is advised that the user only connects the needed number of devices.

PAN profile

The Bluetooth connectivity uses a wireless personal area network (WPAN) for connection. This provides data transmission from the LT-3110 Control Unit to Bluetooth connected devices. The connectivity is set up using the PAN profile which makes the Bluetooth network emulate an ethernet connection to connected devices. Applications running on connected devices will see the connection as through ethernet due to this simulation. The PAN profile is currently the only supported Bluetooth profile for the LT-3100 system. Therefore, the Bluetooth functionality is limited to offering a data transmission between the connected device and the LT-3100 system.

How to pair

Pairing devices to the LT-3100 using Bluetooth is a straightforward operation. The user must enable Bluetooth on both the LT-3110 Control Unit and the device to pair. Bluetooth is enabled on the LT-3110 Control Unit in the Bluetooth submenu under the Settings menu, this is described in *System Submenus, Settings* on page 81. Figure 88 below shows the Bluetooth submenu with Bluetooth enabled, the system is now ready to pair.

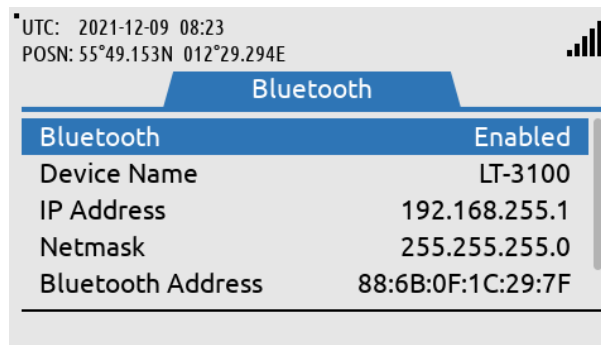

System:
MENU -> Settings->
Bluetooth

Figure 88: Bluetooth - How to pair (1 of 5)

NOTE: For the LT-3100 to be able to pair to a Bluetooth device, the LT-3110 Control Unit must be in the Bluetooth submenu.

The LT-3100 is chosen from the Bluetooth list on the device which shall be connected. From there a pairing code will be displayed on the LT-3110 Control Unit screen, see Figure 89.

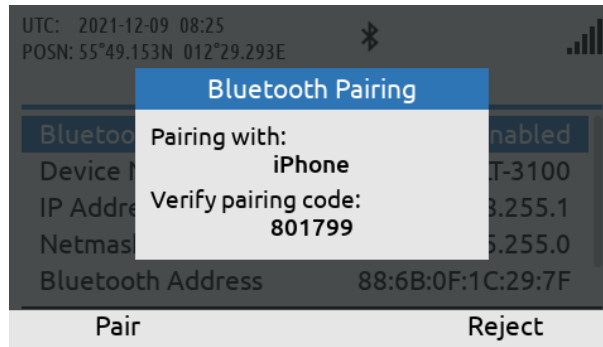

Bluetooth pairing request, press 'Pair' to pair

Figure 89: Bluetooth - How to pair (2 of 5)

The user can now either press 'Pair' to pair with the device or 'Reject' to reject pairing with the device. The 'Pair' softkey is pressed and the device (in this case an iPhone) is connected. The LT-3110 will now display the Bluetooth symbol as displayed on Figure 90.

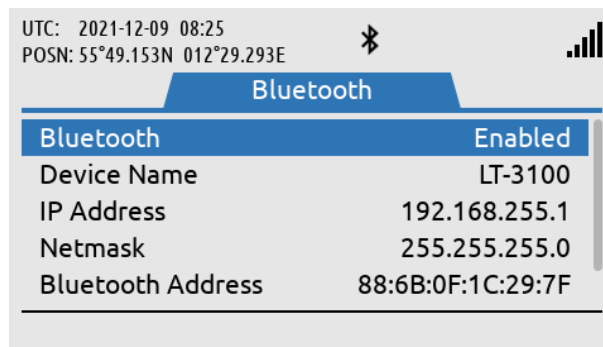

Bluetooth is enabled and a device is connected

Figure 90: Bluetooth - How to pair (3 of 5)

The connected device (in this case the iPhone) will now be displayed under 'Known Devices' at the bottom of the Bluetooth submenu, this is displayed on Figure 91.

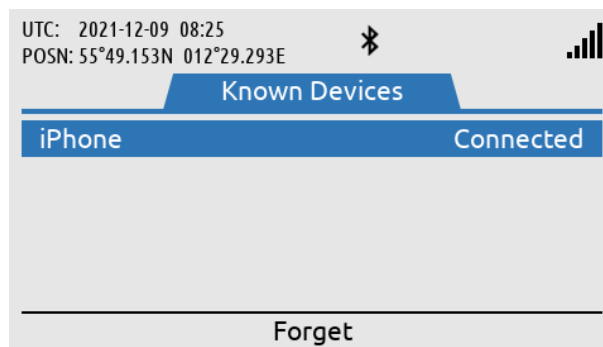

The connected device is shown under 'Known Devices'. Press 'Forget' to remove the device

Figure 91: Bluetooth - How to pair (4 of 5)

To disconnect the device from the LT-3100 the user can either disable Bluetooth on the LT-3110 Control Unit or the paired device or press the 'Forget' softkey. Using the 'Forget' softkey will remove the device from the list as seen on Figure 92.

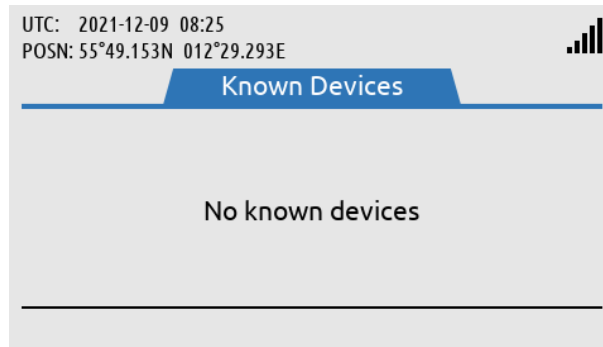

The device has been disconnected and forgotten

Figure 92: Bluetooth - How to pair (5 of 5)

System Submenus

This section describes and illustrates the submenus Phone, Settings, and System. The submenus are accessed by pressing the MENU button.

Phone

The Phone submenu contains the following entries: Contacts, SMS, Call History, Data History and Phone Usage. See Figure 93 for the layout of the Phone submenu.

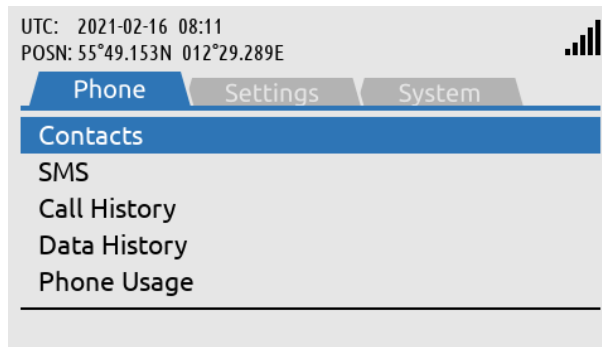

SIP Phones:
MENU -> Phone

Figure 93: Phone submenu

Contacts

The Contacts provides a list of contacts created by the user. Create a new contact by pressing the soft key 'New' and add phone number and/or Email and name. The phone number is limited to numbers (e.g. 004529401008). The Contact list can contain 100 contacts. Use international number prefix, either '+' or '00XX' in front of the number. A contact can be deleted from the list by pressing the soft key 'Delete' and confirm this.

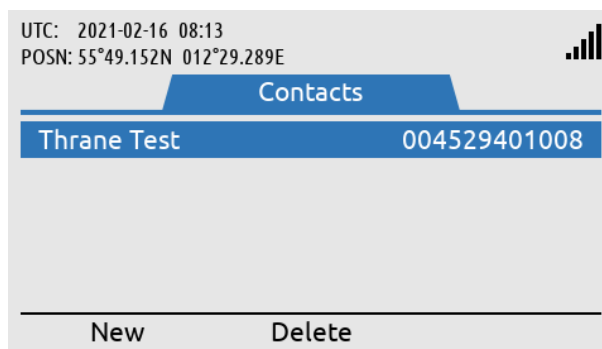

Contacts:
MENU -> Phone ->
Contacts

Figure 94: Phone submenu (Contacts)

NOTE: The user can select an entry from the Contacts (e.g. Thrane Test) and use the Off-hook button to establish a voice call to the contact, if the Contact has a registered phone number.

NOTE: The user must define a Name for the contact but can input both Phone number and Email address or either of the two.

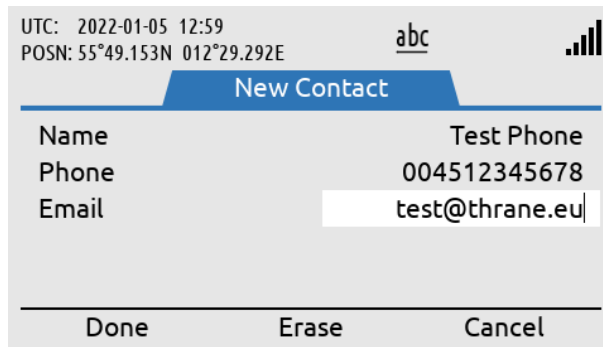

Figure 95: Contacts (New Contact)

SMS

The SMS Service is described and illustrated in SMS on page 60.

Call History

The Call History provides a complete list of all voice calls: outgoing, incoming, and missed calls, as illustrated in Figure 96. ‘Unknown’ entries in the Call History will show the soft key ‘New Contact’ to help creating the ‘Unknown’ contacts in the Contact list. Use the soft key ‘Show Missed’ to filter for incoming missed calls.

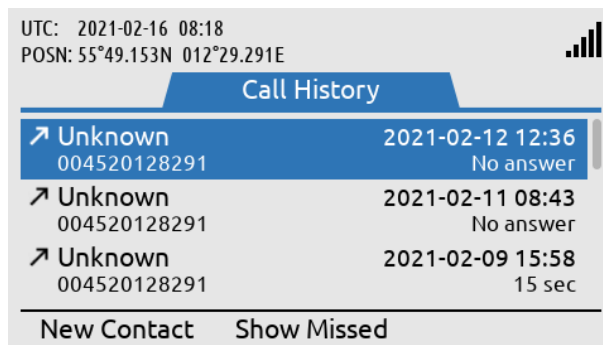

Call History:
MENU -> Phone -> Call History

Figure 96: Phone submenu (Call History)

Data History

The Data History provides a complete list of all Modem Data connections outgoing and incoming connections will be listed. The Data History is illustrated in Figure 97. The Modem Data is further described in *Data (Modem Data, SMS and SBD) on page 68.*

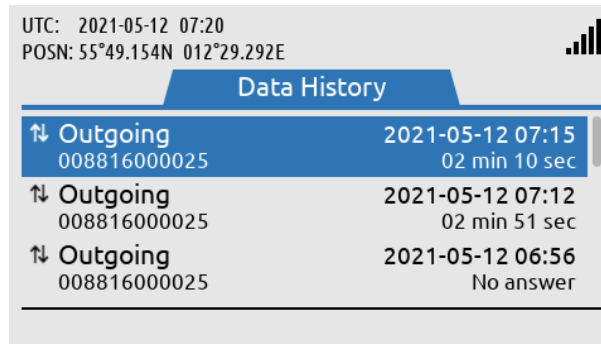

Data History:
MENU -> Phone -> Data History

Figure 97: Phone submenu (Data History)

Phone Usage

The Phone Usage lists Trip and Lifetime user terminal usage. The list includes voice totals for incoming and outgoing voice calls, data incoming and outgoing and SBD sent and received. To switch between Trip and Lifetime usage, press the softkey titled 'Show Lifetime/Trip' This includes Voice totals, SMS totals, Data totals and SBD totals as illustrated in Figure 98 to Figure 101

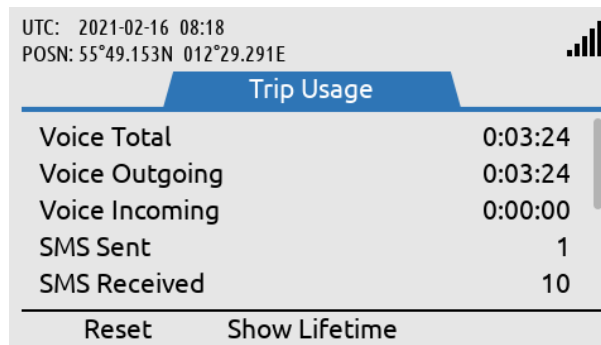

Phone Usage:
MENU -> Phone -> Phone Usage (Trip usage)

Figure 98: Phone submenu (Phone Usage)

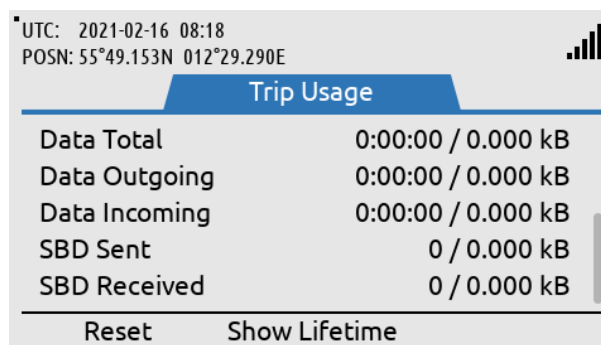

Figure 99: Phone submenu (Phone Usage)

UTC: 2021-02-16 08:19
POSN: 55°49.153N 012°29.290E

📶

Lifetime Usage	
Voice Total	0:03:24
Voice Outgoing	0:03:24
Voice Incoming	0:00:00
SMS Sent	1
SMS Received	10

Show Trip

Phone Usage:
MENU -> Phone -> Phone
Usage
(Lifetime usage)

Figure 100: Phone submenu (Phone Usage)

UTC: 2021-02-16 08:19
POSN: 55°49.153N 012°29.290E

📶

Lifetime Usage	
Data Total	0:00:00 / 0.000 kB
Data Outgoing	0:00:00 / 0.000 kB
Data Incoming	0:00:00 / 0.000 kB
SBD Sent	0 / 0.000 kB
SBD Received	0 / 0.000 kB

Show Trip

Figure 101: Phone submenu (Phone Usage)

Settings

The Settings submenu contains the following entries: Audio, Display, Date & Time, Phone Setup, Bluetooth, Security and Reset Options. See Figure 102 and Figure 103 for the layout of the Settings submenu.

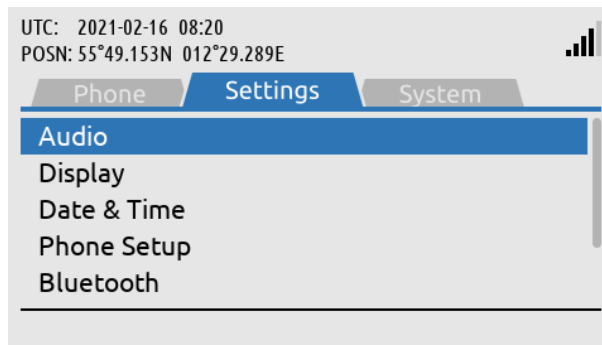

Settings:
MENU -> Settings
(upper view)

Figure 102: Settings submenu

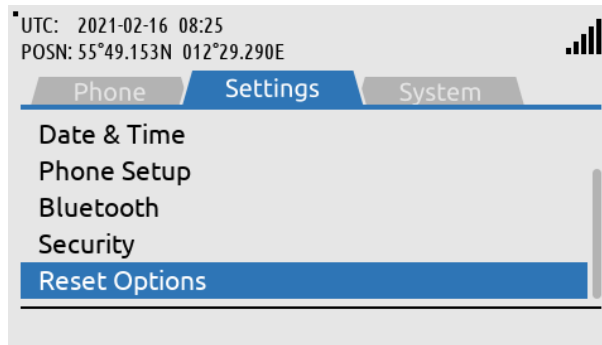

Settings:
MENU -> Settings
(lower view)

Figure 103: Settings submenu

Audio

The Audio settings handles all audio levels and notifications. Here is a short description of the audio settings and their functionality in the LT-3100 system (see Figure 104 for layout):

- *Speaker Volume* adjusts the output level of the LT-3110 Control Unit speaker (located below the Brightness button). The Speaker Volume setting is primarily used when operating the system with the LT-3120 Handset placed in LT-3121 Cradle (e.g. making a voice call). The Navigation key (arrows up/down) can be used to control the Speaker Volume output level, when audio is directed to control unit speaker.
- *Handset Volume* adjusts the output level of the LT-3120 Handset speaker (user audio). The user can adjust the Handset Volume during a voice call by using the LT-3120 Handset volume button (up/down) on the side of the handset.
- *Ringer Volume* adjusts the output level of the ringer, when an incoming voice call is presented in the LT-3100 system. The Ringer output will be directed to the LT-3120 Handset (integrated ringer speaker on the back side) when placed in the LT-3121 Cradle. Otherwise, the LT-3110 Control Unit speaker is used for indicating an incoming voice call.
- *Key Beep* adjusts the output level of the audio feedback when using the LT-3110 Control Unit keypad. Can be configured to 'Off' if desired.

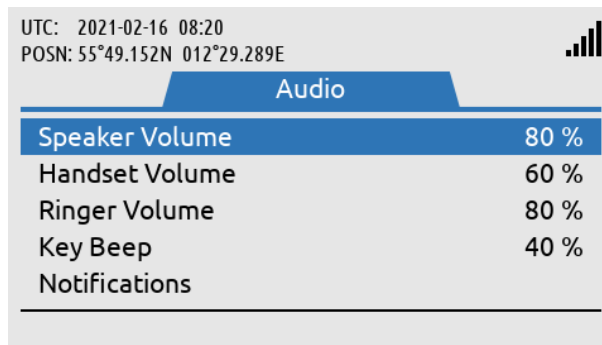

Audio:
MENU -> Settings ->
Audio

Figure 104: Settings submenu (Audio)

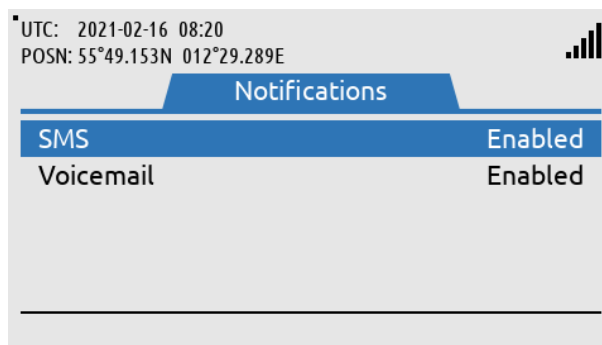

Notifications:
MENU -> Settings ->
Audio -> Notifications

Figure 105: Settings Submenu (Notifications)

NOTE: Audio notifications can be disabled for SMS. The unread symbol in the status bar will still be shown, if audio notifications are disabled.

Display

The Display settings handles all display settings: mode (day or night time) and brightness.

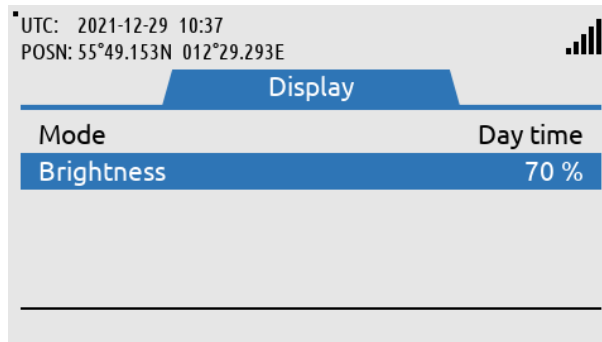

Display:
MENU -> Settings ->
Display

Figure 106: Settings submenu (Display)

NOTE: The display settings can also be configured using the 'Brightness' button. Short press on the 'Brightness' button changes the brightness, whereas long press on the 'Brightness' button changes between day and night time.

Date & Time

Date & Time settings provides the user with a possibility to change formats after completing the Installation Wizard. The LT-3100 system supports the following date formats: YYYY-MM-DD, D MMM YYYY, DD/MM/YYYY, and MM/DD/YYYY. The time format can be configured to either 24 or 12 hours.

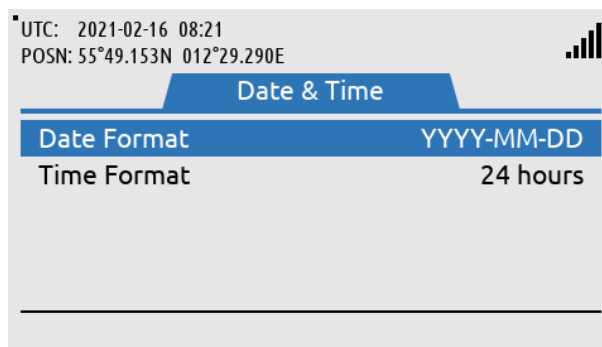

Date & Time:
MENU -> Settings -> Date
& Time

Figure 107: Settings submenu (Date & Time)

Phone Setup

Phone Setup provides the user with phone numbers to the Voicemail and to the SMS Service Center. This is illustrated on Figure 108 . Note that these numbers are not dialable from this menu.

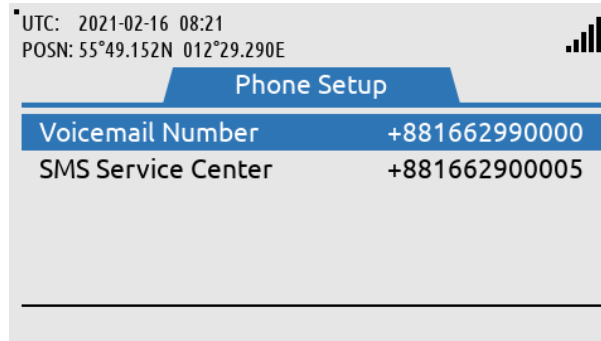

Phone Setup:
MENU -> Settings ->
Phone Setup

Figure 108: Settings submenu (Phone Setup)

Bluetooth

The Bluetooth submenu offers the user the ability to wirelessly connect devices to the LT-3100 using Bluetooth. How to setup this connection is described in *Bluetooth, How to pair* on page 74.

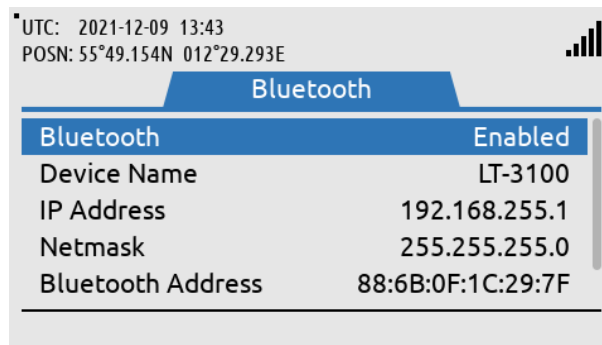

Phone Setup:
MENU -> Settings ->
Bluetooth

Figure 109: Settings submenu (Bluetooth)

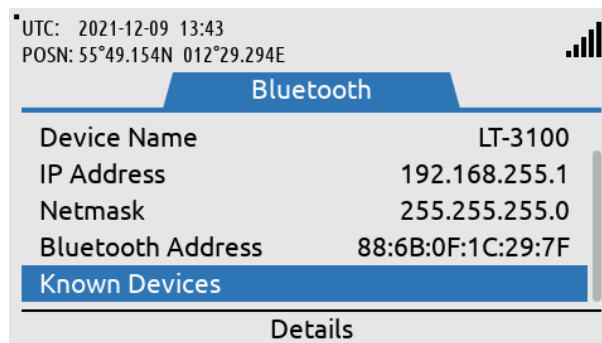
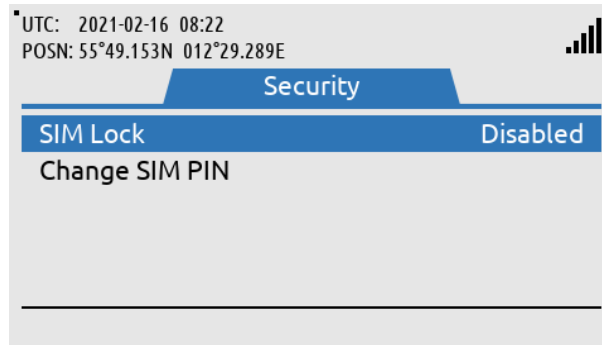

Figure 110: Settings submenu (Bluetooth)

Security

The security submenu allows the user to configure settings regarding SIM Lock and changing the SIM PIN code, this is illustrated on Figure 111. To Enable SIM Lock the SIM PIN code is required, as seen on Figure 112.



Phone Setup:
MENU -> Settings ->
Security

Figure 111: Settings submenu (Security)

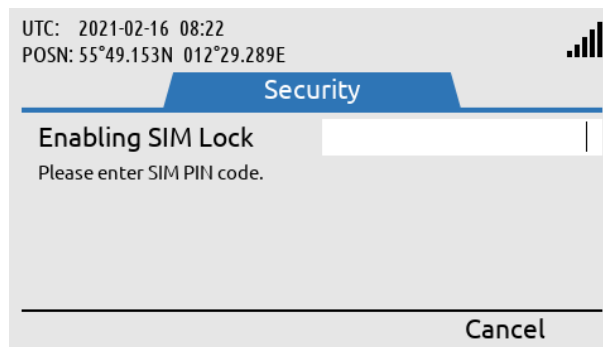

SIM PIN is required to
enable SIM Lock

Figure 112: Settings submenu (Security)

To change the SIM PIN the user is required to input the current SIM PIN and then select a new SIM PIN. The New SIM PIN must be repeated before it is confirmed. See Figure 113 to Figure 115 for an illustration of this process.

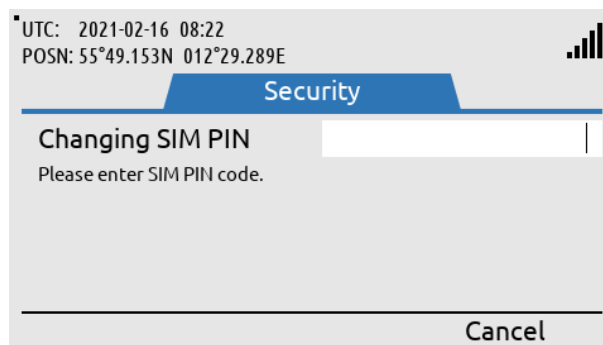

To change SIM PIN the
current SIM PIN is
required

Figure 113: Settings submenu (Security)

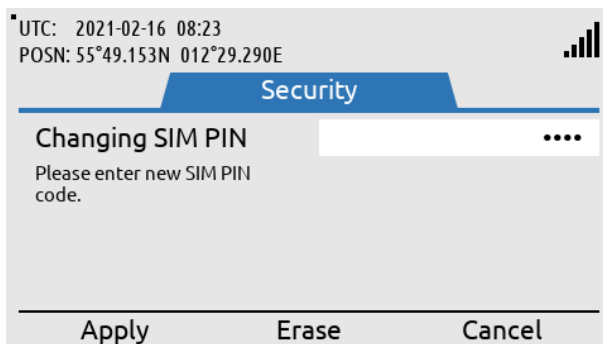

A new SIM PIN is entered

Figure 114: Settings submenu (Security)

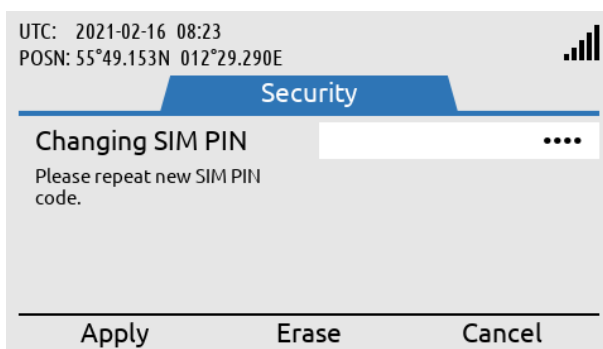

The new 4 digit SIM PIN must be repeated

Figure 115: Settings submenu (Security)

NOTE: To change SIM PIN the SIM Lock feature has to be enabled.

NOTE: There is a minimum requirement of four digits for new SIM PIN's. There is however no max limit of digits.

Reset Options

The Reset Options handles the reset of the following user records and configurations: Call History, SMS, and Web Server Authentication. Use the soft key 'Execute' or the 'ENTER' button to activate the reset, when the correct Reset Option has been selected by the 'Navigation' key (arrow up/down). The user of the LT-3100 system will have to confirm the reset, see Figure 116 and Figure 117.

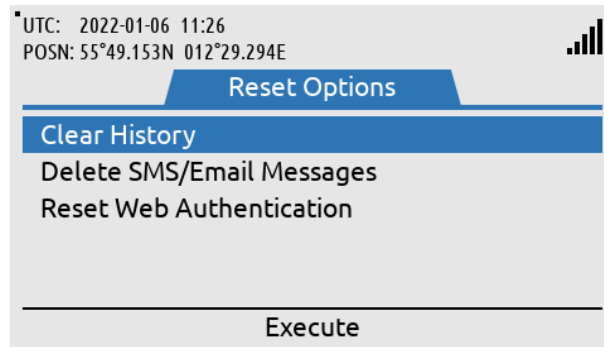

Phone Setup:
MENU -> Settings ->
Reset Options

Figure 116: Settings submenu (Reset Options)

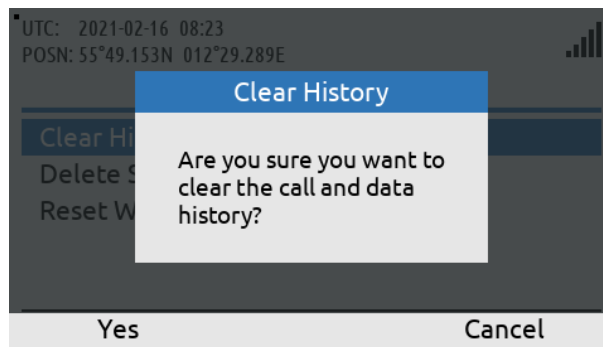

The user must confirm the reset to clear the selected data from memory

Figure 117: Settings submenu (Reset Options)

NOTE: The reset of the web server authentication can be managed from the Settings submenu for the user to get access to the web server in the situation where the user cannot find the changed password. To avoid unwanted access to the web server via the network interface, it is highly recommended to change the web server authentication password at any time. The web server authentication is described and illustrated in *Authentication* on page 106.

System

The System submenu contains the following entries: BAM Alert, Network, Tracking, SIP Phones, Position Status, System Info, and Power Supply. See Figure 118 and Figure 119 for the layout of the System submenu.

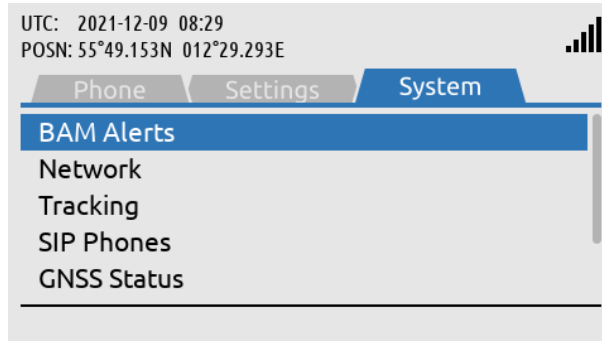

System:
MENU -> System
(upper view)

Figure 118: System submenu

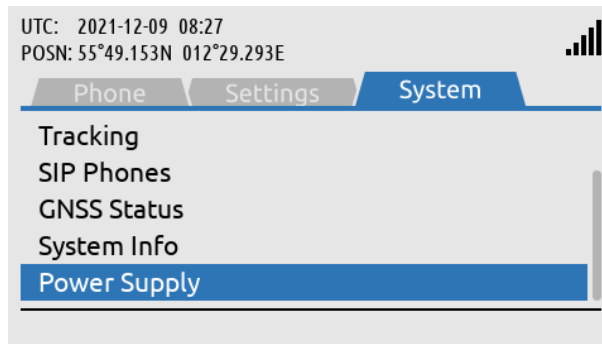

System:
MENU -> System
(lower view)

Figure 119: System submenu

BAM Alerts

BAM Alerts provides an overview of the active alerts in the LT-3100 system. The Bridge Alert Management (BAM) is described and illustrated in detail in *Bridge Alert Management (BAM)* on page 93.

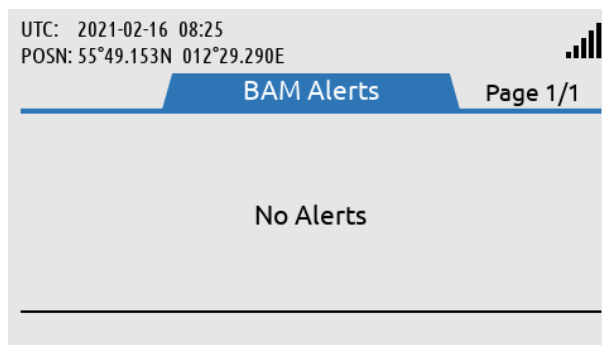

BAM Alerts:
MENU -> System -> BAM
Alerts (or long press on
the MENU button)

Figure 120: System submenu (BAM Alerts)

NOTE: The BAM Alerts list illustrated in Figure 120 should under normal conditions be empty (No Alerts). Make sure to read the alerts carefully and take appropriate action.

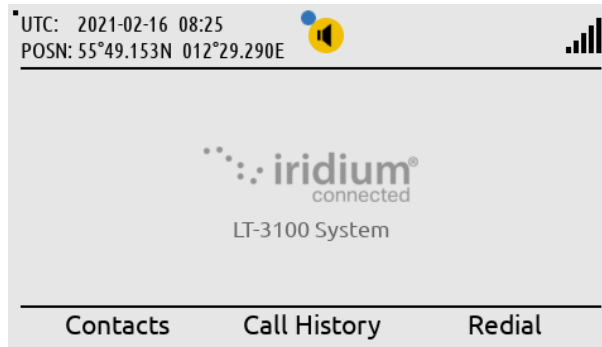

BAM alert shown in the status bar (active warning). The blue dot indicates a change in the BAM Alerts, after the user has last been in the list.

Figure 121: BAM Alerts (1 of 4)

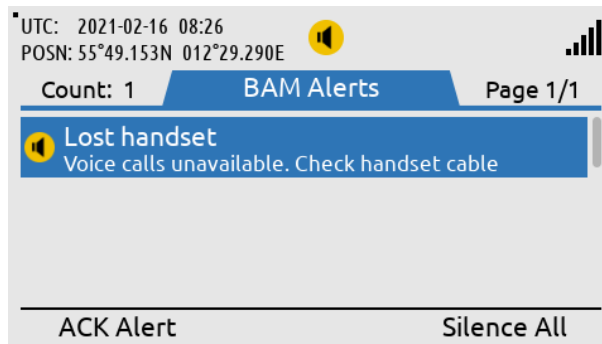

Long press on the MENU button to access the BAM Alerts (Lost Handset).

Figure 122: BAM Alerts (2 of 4)

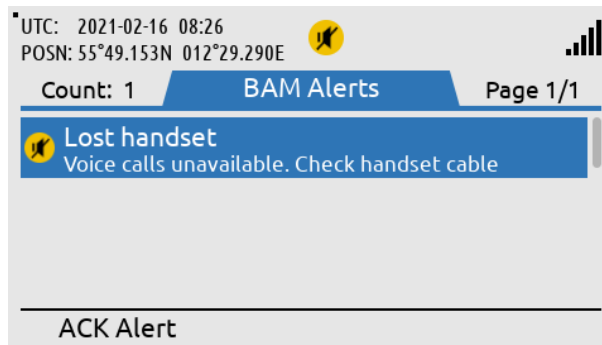

Press the soft key 'Silence All' to mute the audible alarm for 30 seconds.

Figure 123: BAM Alerts (3 of 4)

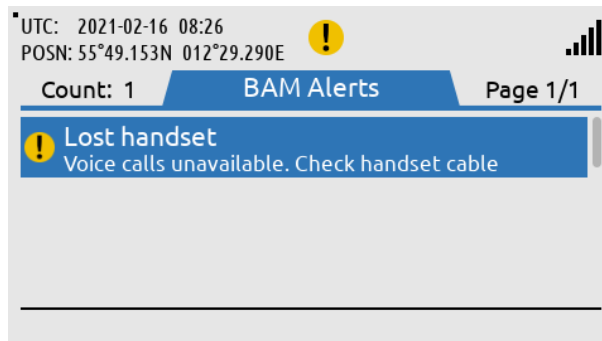

Press the soft key 'ACK Alert' acknowledge the BAM alert.

Figure 124: BAM Alerts (4 of 4)

Network

The Network provides an overview for the user of the LT-3100 system of the IP network configuration and setup. The LT-3100 system can be configured to: DHCP Client, DHCP Server, and Static IP address. The link status will provide the user with information about and whether an IP connection is established to the LT-3110 Control Unit. The IP address of the LT-3110 Control Unit is provided under the IP Address parameter illustrated in Figure 125.

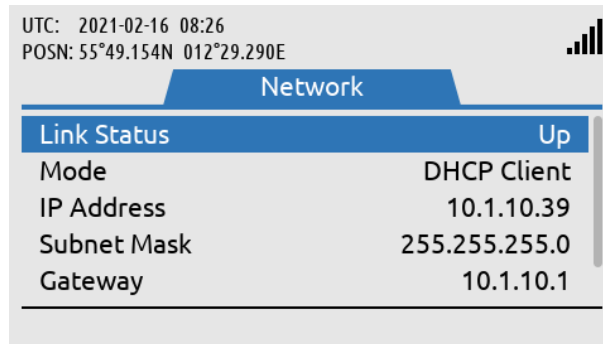

Network:
MENU -> System ->
Network

Figure 125: System submenu (Network)

NOTE: Use the IP Address to access the built-in web server. Instructions to access the built-in web server is provided in *Accessing the built-in web server* on page 101.

Tracking

The Tracking functionality is described and illustrated in *Tracking* on page 71.

SIP Phones

The SIP Phones functionality is described and illustrated in *External SIP Phones* on page 65.

GNSS Status

The Position Status provides an overview for the user of the LT-3100 system built-in GNSS receiver. The GNSS receiver can be configured from the web server, see *GNSS and BAM* on page 124.

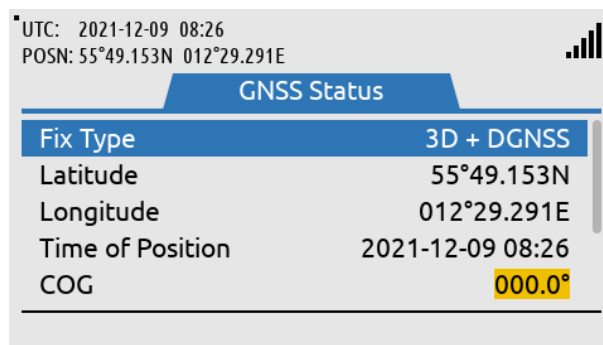

GNSS Status:
MENU -> System -> GNSS
Status
(upper view)

Figure 126: System submenu (GNSS Status)

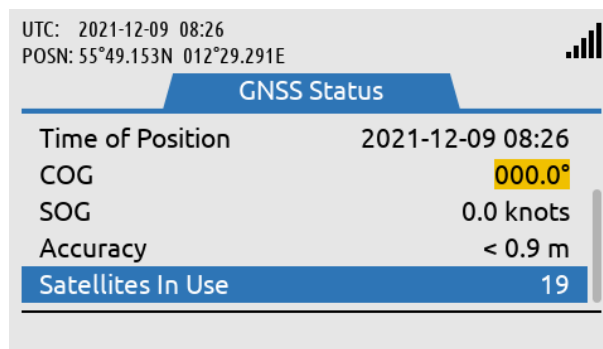

GNSS Status:
MENU -> System -> GNSS
Status
(lower view)

Figure 127: System submenu (GNSS Status)

NOTE: The GNSS Status window shows the GNSS receiver status (in Automatic GNSS mode). The Manual Position input will not be shown in the Position Status window. The Position Status (Automatic GNSS) integrity states are further described and illustrated in *App. F - GNSS Receiver Integrity States* on page 140.

System Info

The System Info provides details about the LT-3100 system software and hardware. In addition, the following numbers are available: MSISDN (~satellite phone number), IMEI (~mobile equipment number), and ICCID (~SIM card number). The System Info is illustrated in Figure 128 and in Figure 129.

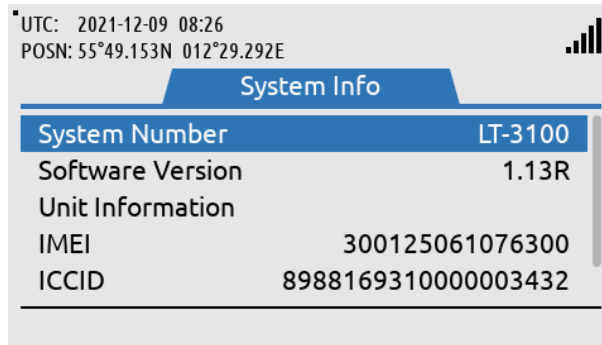

System Info:
MENU -> System -> System Info
(upper view)

Figure 128: System Submenu (System Info)

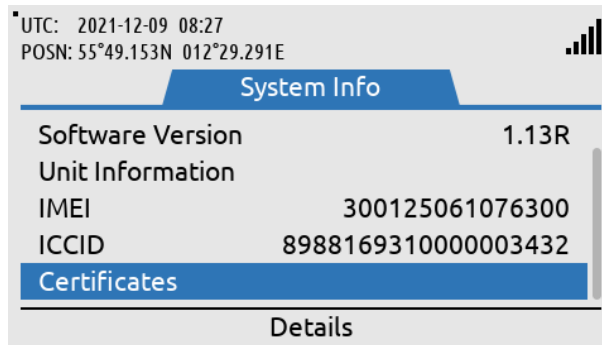

System Info:
MENU -> System -> System Info
(lower view)

Figure 129: System submenu (System Info)

Power Supply

The Power Supply provides details about the DC input voltage on the LT-3110 Control Unit and LT-3130 Antenna Unit.

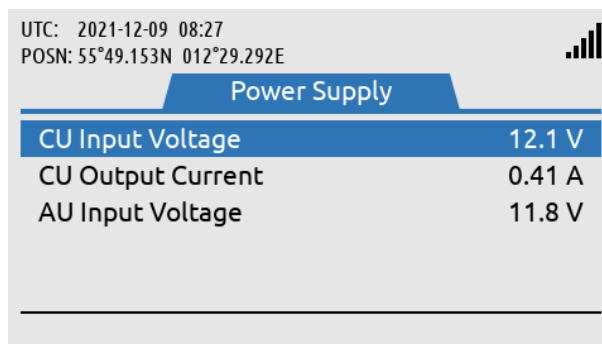

Figure 130: System submenu (Power Supply)

Bridge Alert Management (BAM)

Bridge Alert Management (BAM) is the IMO defined overall concept for the harmonized management, distribution, handling and presentation of alerts on the bridge, to enable the bridge team to devote full attention to the safe operation of the ship and to immediately identify any alert situation requiring action to maintain the safe operation of the ship. The LT-3110 system implements the BAM concept in compliance with the relevant standards (IEC 62923-1 and IEC 62923-2 Bridge Alert Management).

BAM status

The LT-3100 system continuously monitors for fault conditions (e.g. no satellite signal), that requires the attention of the bridge team and raises relevant alerts. The user can, at any time, check for the presence of alerts without performing any action: if there are one or more active alerts, a BAM icon representing the alert with the highest priority is shown in the status bar (see Figure 131). The exact icon shown depends on the priority and state of the alert with the highest priority (see Table 24 on page 94). It is not possible to hide or suppress the BAM icon in the status bar.

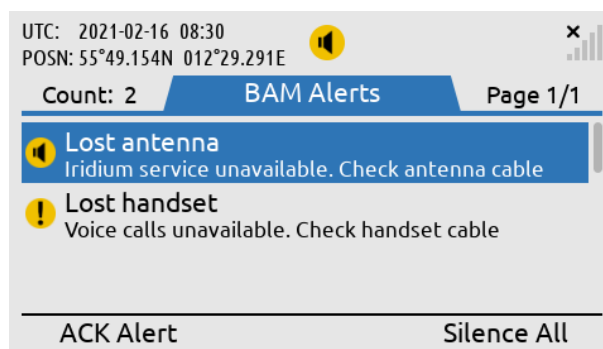

Figure 131: LT-3110 Control Unit (BAM status)

Alert list

Once the user has become aware an alert has been raised, the user can navigate to the alert list (MENU -> System -> BAM Alerts) to find further information about the alert conditions.

NOTE: For quick access to the alert list, long press (≥ 1 s) the MENU button at any time.



The BAM Alerts window will list the current unacknowledged and acknowledged alerts.

Figure 132: LT-3110 Control Unit (BAM Alert list)

See *App. B - Bridge Alert Management (BAM)* on page 134 for the full list of alerts that can be raised by the LT-3100 system.

Alert priority and state

The *priority* of an alert indicates its severity. The BAM concept defines 4 priorities: Emergency Alarm, Alarm, Warning and Caution. The LT-3100 system can raise alerts of the following priorities:

- **Warning:** Condition requiring immediate attention, but no immediate action by the bridge team. Warnings are presented for precautionary reasons to make the bridge team aware of changed conditions which are not immediately hazardous but may become so if no action is taken.
- **Caution:** Lowest priority of an alert. Awareness of a condition which does not warrant an alarm or warning condition, but still requires attention out of the ordinary consideration of the situation or of given information.

The shape and color of the BAM icon indicates the priority of the alert and the symbol inside indicates its state as per Table 24 below.







BAM Alert Icons, Priority and Stat				
Priority	Icon	State	Condition	Audible signal
Warning		Active – unacknowledged	Alert condition present. Alert not acknowledged.	Yes
		Active – silenced	Alert condition present. Alert not acknowledged, but audible signal has been silenced by the operator.	No
		Active – acknowledged	Alert condition present. Alert acknowledged by the operator.	No
		Active – responsibility transferred	Alert condition present. A function of the BAM compliant equipment with additional system knowledge has taken over.	No
		Rectified – unacknowledged	Alert condition rectified. Alert still unacknowledged.	No
	None	Normal	No alert condition present.	No
Caution		Active	Alert condition present.	No
	None	Normal	No alert condition present.	No

Table 24: BAM Alert Icons, Priority and State

Temporary silence

Active unacknowledged alerts cause a short but periodically repeated audible signal. To temporarily silence all alerts (and thus the audible signal), press the “Silence All” soft key. The temporary silence period expires after 30 s, after which active silenced alerts become active unacknowledged alerts again, causing the audible signal to resume.

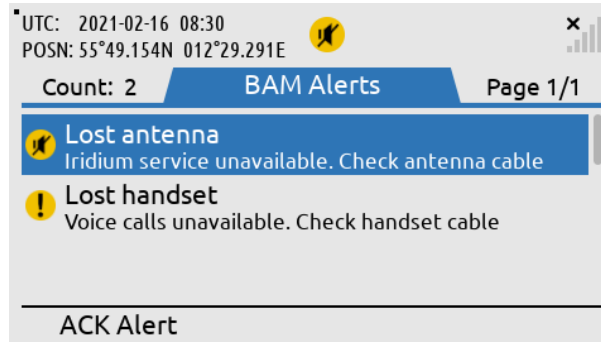

Figure 133: LT-3100 Control Unit (BAM Alerts)

NOTE: Active unacknowledged alerts cause a short but periodically repeated audible signal, which can be temporary silences (30 s) by pressing the soft key ‘Silence All’. This temporary silence has been illustrated in Figure 133.

Alert acknowledgement

Alerts of priority warning must be acknowledged by the user. To acknowledge an alert, press the “ACK Alert” soft key.

Some alerts cannot be acknowledged by the user, in which case the “ACK Alert” soft key will be absent. This applies to alerts for which the alert text and alert description is not enough for decision support.

When an alert is both acknowledged and rectified it disappears from the alert list. Cautions cannot be acknowledged and thus disappear as soon as they are rectified.

Aggregation

The BAM concept defines aggregation as a means for an alert source to combine multiple individual alerts of the same kind into a single aggregated header alert in order to help reduce the risk that the number of individual alerts obscures the display of equally important additional alerts, for example due to the active alert list length exceeding the maximum display capability of the alert source UI.

NOTE: The LT-3100 system currently does not define any alerts that can be aggregated.

Responsibility transfer

The BAM concept defines the Central Alert Management (CAM) system as equipment used for centralizing management, handling and presentation of alerts on the bridge. A CAM system may be standalone or combined with other equipment, for example in the case of an Integrated Navigation System (INS).

A CAM system connects to multiple alert sources (such as the LT-3100 system) in order to manage and present their alerts on the CAM UI. An alert will thus be presented in the alert list of both the alert source and the CAM system.

To reduce the number of high-priority audible alerts for one situation that requires attention, if the CAM system has additional knowledge regarding an alert situation, which caused the LT-3100 system to raise an alert, the CAM system may apply responsibility transfer and raising a new alert with, if practicable, a lower priority.

NOTE: Alerts of priority caution are not audible and therefore cannot have their responsibility transferred.

NOTE: The LT-3100 will reject the request for responsibility transfer if no HBT sentence (indicating good status) has been received from the CAM system within the last 90 s.

The alert text and alert description of an alert is presented on the CAM system. For some alerts, additional information must be presented in order to allow user acknowledgement of the alert. Responsibility transfer is not allowed for such alerts as they can only be acknowledged at the alert source, where the additional information is present.

Time synchronization

The LT-3100 system can supply the UTC time of alert state changes to the CAM system due to the built-in GNSS receiver.

NOTE: If the alert state change occurs before the built-in GNSS receiver has obtained the UTC time or in case of GNSS receiver malfunctioning, the LT-3100 system will not supply the UTC time.

Serial Interface (RS-422)

GNSS sentences

The LT-3100 system supports outputting of GNSS sentences encoded as NMEA 0183 via an RS-422 interface from the LT-3100 system, as illustrated in Figure 134. The LT-3100 system has a built-in GNSS receiver in the LT-3130 Antenna Unit.

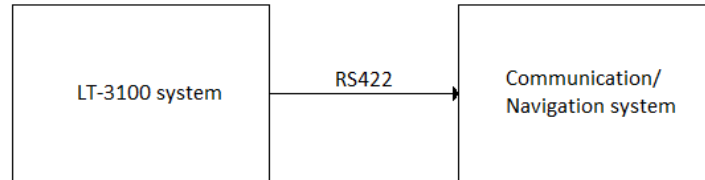

Figure 134: GNSS sentences

Table 25 presents the supported GNSS sentences by the LT-3100 system. The configuration of the GNSS sentences are illustrated and described in *GNSS and BAM* on page 124.

GNSS Sentences			
Sentence	Baud Rate		
	4.800	9.600	38.400
DTM	X	X	X
GGA	X	X	X
GLL	X	X	X
GSA	X	X	X
GSV	-	X	X
RMC	X	X	X
VTG	X	X	X
ZDA	X	X	X

Table 25: GNSS sentences

IMPORTANT: The GNSS receiver of the LT-3100 system is not certified according to IMO performance standards for GNSS receivers. The LT-3100 system shall not be connected to equipment where the GNSS receiver interface must be certified.

The GNSS sentences and decoding of these are further documented in *App. D - GNSS sentences* on page 138.

BAM sentences

The LT-3100 system supports connection to an external Central Alert Management (CAM) system via an RS-422 interface from the LT-3100 system, as illustrated in Figure 135. The CAM system can receive BAM information (e.g. warning and cautions) from the bridge equipment and centralize and present this information to the user, which can be acknowledged to the BAM equipment (here the LT-3100 system).

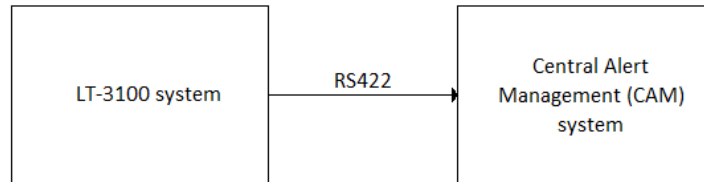

Figure 135: CAM/BAM system

Table 26 presents the supported BAM sentences by the LT-3100 system. The configuration of the BAM sentences is illustrated and described in *GNSS and BAM* on page 124.

Sentences Received by SES		
Sentence	Name	Comment
ACN	Alert Command	Alert command for instance acknowledge
HBT	Heartbeat	Support reliable alert related communication
Sentences Transmitted by SES		
Sentence	Name	Comment
ARC, ALC, ALF	Alert information	

Table 26: BAM sentences

NOTE: The encoding of BAM sentences is defined in IEC 61162-1 (Edition 5.0, 2016-08), the encoding is similar to NMEA 0183.

The BAM sentences and decoding of these are further documented in *App. E - BAM Sentences* on page 139.

NMEA 0183 over UDP

The LT-3100 system is supporting transmission of NMEA 0183 sentences (GNSS position information) via the LAN or Bluetooth interface. The supported protocol is UDP (only broadcast).

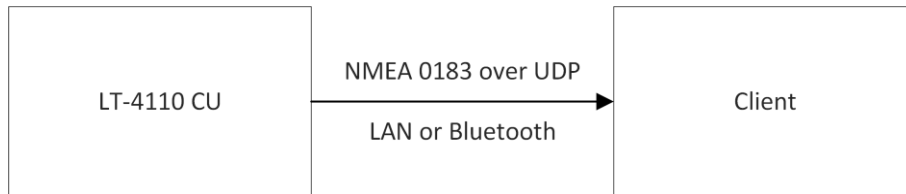

Figure 136: NMEA 0183 over UDP (broadcast)

The IP destination address will always be the local broadcast address of the LAN or BT network. I.e., if the configured LAN network address/mask is 192.168.1.0/24 the destination address will be 192.168.1.255.

The UDP destination port is user configurable, see Table 27.

UDP broadcast Port Configuration	
Interface	Port Number
LAN	1 to 65535
Bluetooth	1 to 65535

Table 27: UDP Broadcast Port Configuration

The configuration of the NMEA 0183 over UDP is illustrated in section *GNSS and BAM* on page 124. The Talker ID of the NMEA 0183 sentences can be changed by changing the configuration of the GNSS Receiver.

NOTE: Currently it is only possible to send NMEA 0183 sentences (GNSS position information) on one interface at a time. I.e., selecting CU LAN will disable GNSS on the RS-422 interface and vice versa.

Web server

The LT-3110 Control Unit has a built-in webserver, which can be accessed from the Ethernet (RJ45) interface from the back side of the control unit. A PC must be connected to the control unit, either directly by connecting an Ethernet cable between a PC and the LT-3110 Control Unit, or by connecting the LT-3110 Control Unit to a Local Area Network (LAN), to where the PC is connected.

NOTE: The IP address allocated to the LT-3110 Control Unit, is shown in the GUI (Menu -> System -> Network: IP Address).

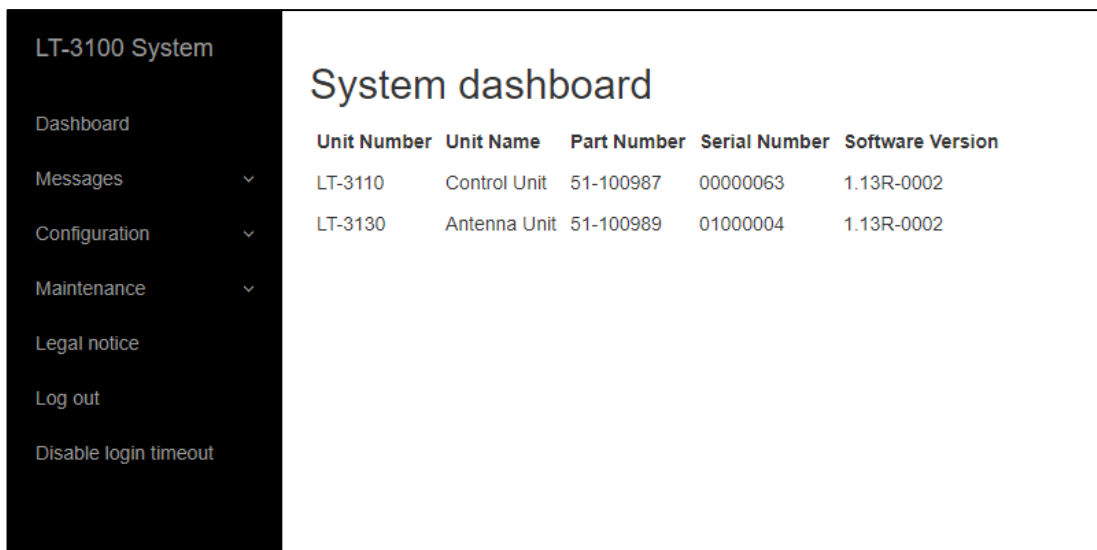

Figure 137: Web server (System dashboard)

The functionality of all web pages is described in further detail in the following sections. Some of the sections will refer to other sections in this User & Installation Manual, e.g. hardware interfaces.

NOTE: All web pages functionality will be described in detail for the LT-3100 system. It is the intention that the web pages should be used during the installation and configuration of the system. During normal operation of the system, it shouldn't be necessary to access the web pages.

Accessing the built-in web server

To access the built-in web server of the LT-3100 system, please complete the following steps:

1. Connect the LT-3110 Control Unit directly to a PC using an Ethernet cable or connect the LT-3110 Control Unit to a Local Area Network (LAN), where a PC is connected.
2. Identify the IP address that is assigned to the LT-3110 Control Unit. The IP address can be read out from the display (MENU -> System -> Network: IP Address). The IP address is valid if the 'Link Status' is showing 'Up'. The IP address is assigned dynamically by a DHCP server.
3. From the PC, start a browser (e.g. Microsoft Edge, Explorer, Chrome, etc.) and type in the IP address, which was identified in the LT-3110 Control Unit (e.g. 10.1.10.39).
4. The browser might show you a warning about an invalid web server certificate, as illustrated in Figure 138. Make sure, that you have typed in the correct IP address.
5. Press 'Details' and you will be presented for an extended page view (including a link), which will direct you to the LT-3100 system dashboard 'Go on to the webpage (Not recommended)'.
6. You will now see the LT-3100 system dashboard.

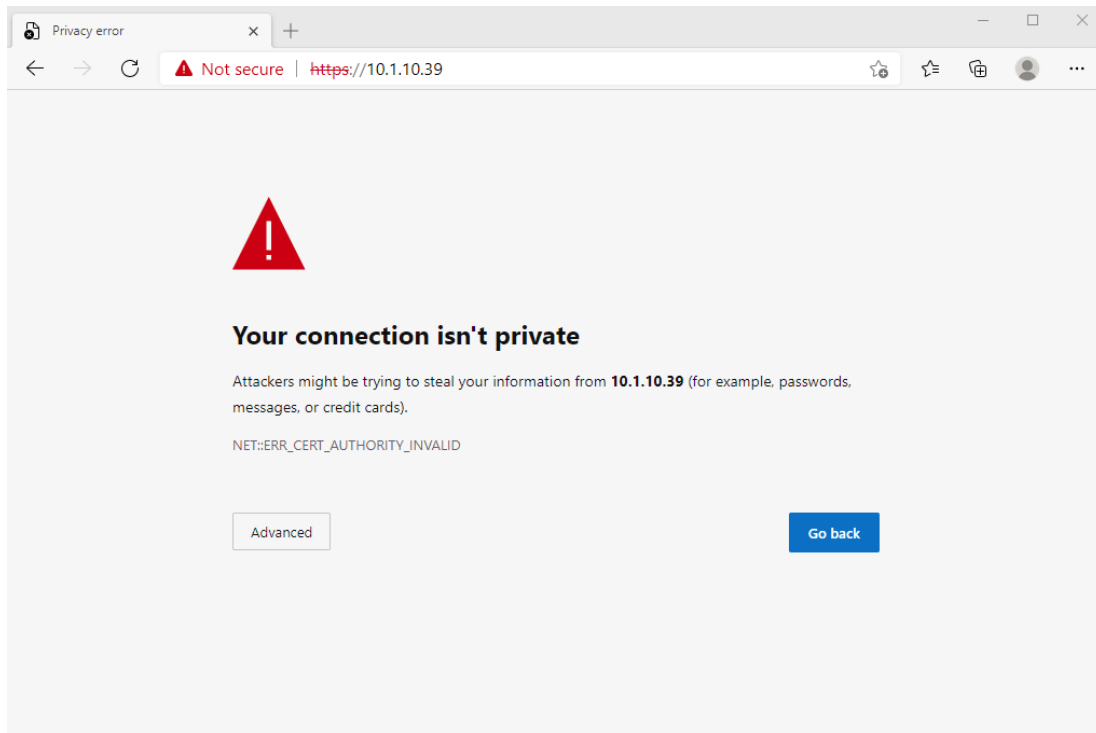

Figure 138: Accessing the built-in web server ("This site is not secure").

Dashboard

The dashboard is showing details about the two main units, which forms the Satcom system: the LT-3110 Control Unit and the LT-3130 Antenna Unit. If the antenna unit is connected properly to the control unit, then the antenna unit will be visible on the web server dashboard, as illustrated in Figure 139. Otherwise only the control unit will be visible. For each unit, the following information will be available: unit number, unit name, unit part number, unit serial number, and software version. The antenna unit will automatically be updated with the software version, which is available in the control unit.

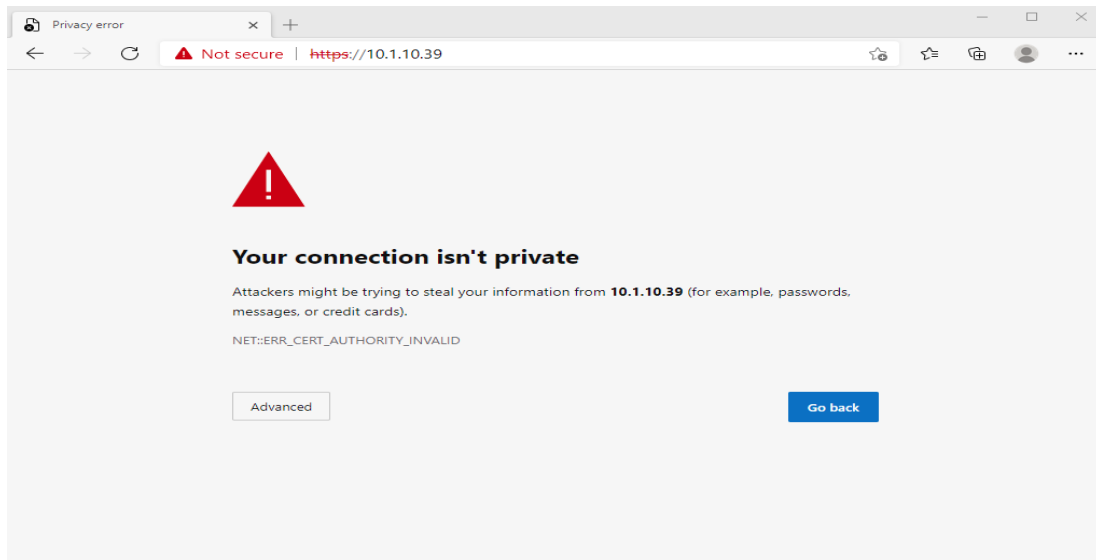

Figure 139: LT-3110 Control Unit - built-in web server (dashboard).

The web server has the following web pages:

- Dashboard
- Messages
- Configuration
- Maintenance
- Legal notice
- Log out
- Disable login timeout

Messages

Email

The LT-3100 system is supporting Email which is described in *SMS* on page 60. The LT-3100 system is offering the ability to read compose and send Email via the web server as illustrated in Figure 140. By clicking on the individual Email the message will expand and the user can read the content of the message. Reading an Email on the Web server clears the SMS notification on the LT-3110 Control Unit

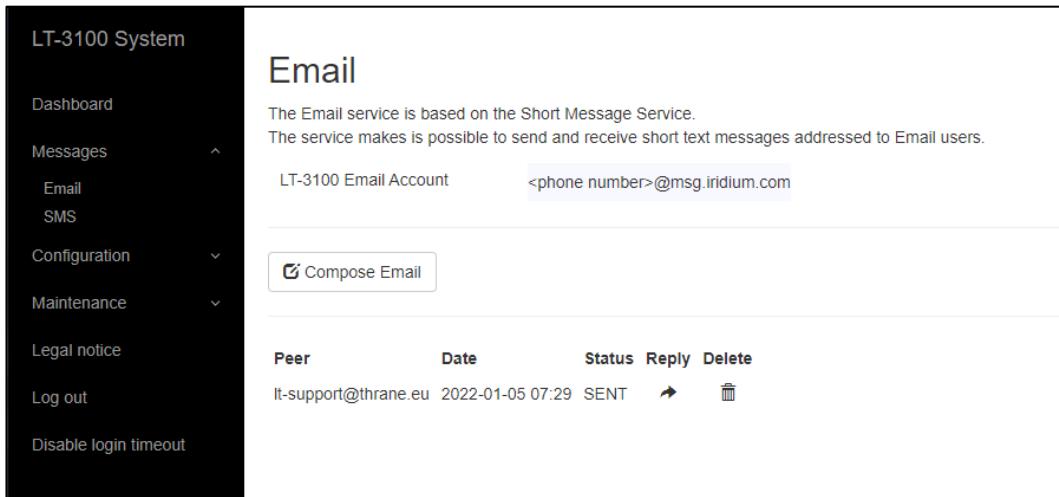

Figure 140: Web server (Email)

To compose an Email either click the “Compose Email” field or reply to a specific Email by clicking the “Reply” arrow next to the Email. To compose an Email input the receiving Email address and the Email text. This is illustrated on Figure 141.

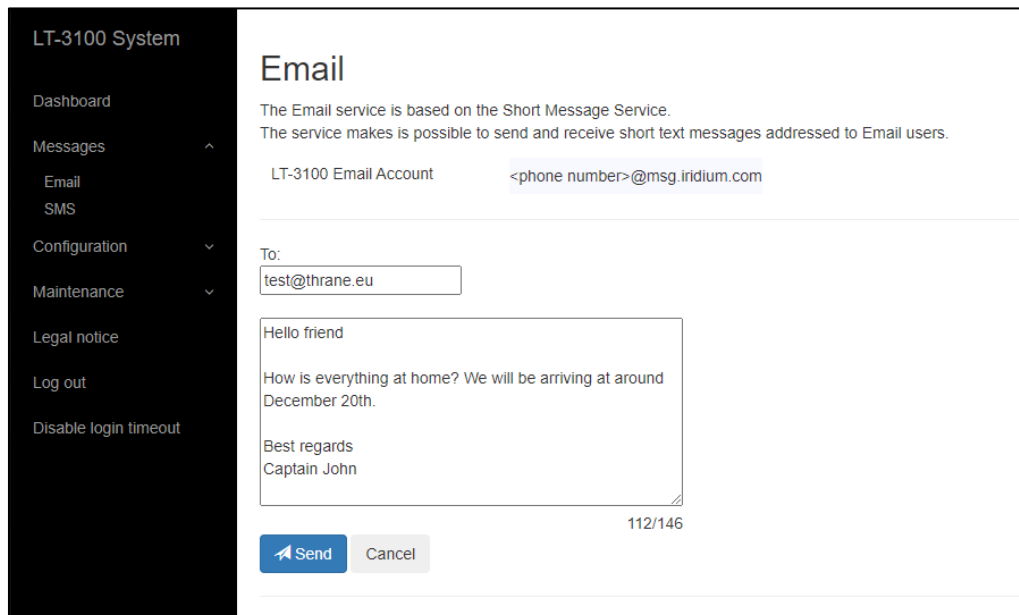

Figure 141: Web server (Email)

NOTE: The Email message can contain 135 characters at a maximum (including spaces and symbols)

SMS

The LT-3100 system is supporting short message service (SMS), which is described in *SMS* on page 60. The LT-3100 system is offering the ability to read compose and send SMS via the web server as illustrated in Figure 142. By clicking on the individual SMS the message will expand and the user can read the content of the message. Reading an SMS on the Web server clears the SMS notification on the LT-3110 Control Unit.

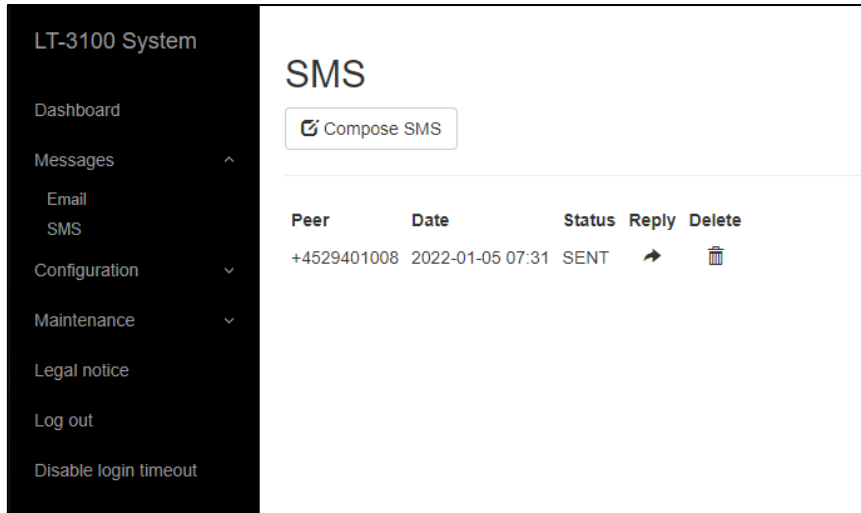

Figure 142: Web server (SMS)

To compose an SMS either click the “Compose SMS” field or reply to a specific SMS by clicking the “Reply” arrow next to the SMS. To compose an SMS input the receiving phone number and the SMS text. This is illustrated on Figure 143.

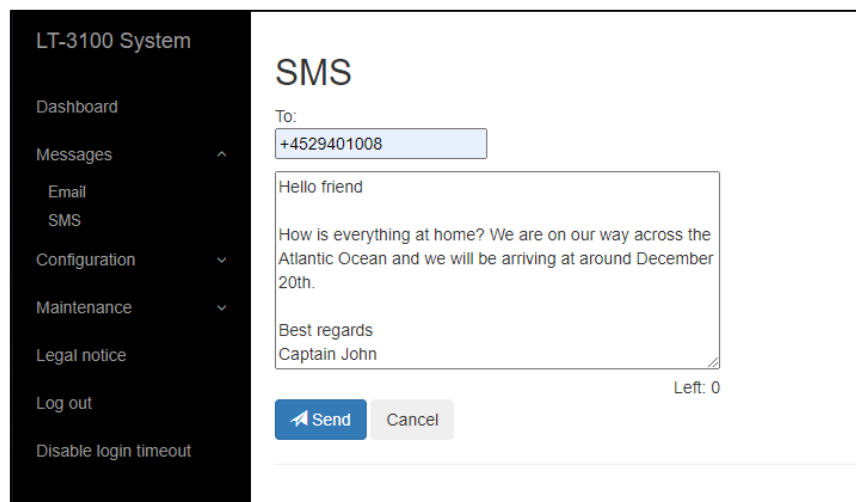

Figure 143: Web server (SMS)

NOTE: The SMS text can be 160 characters long. This includes spaces, symbols, letters, and paragraph changes.

NOTE: For both SMS and Email it is possible to input a Contact in the ‘To’ field. This requires the contact to have a valid phone number and/or Email.

Configuration

After installation of the LT-3100 system has been properly performed, the system is fully operational. In this section there will be a description of system settings which are configurable from the Web Server.

Under Configuration, the following webpages are available:

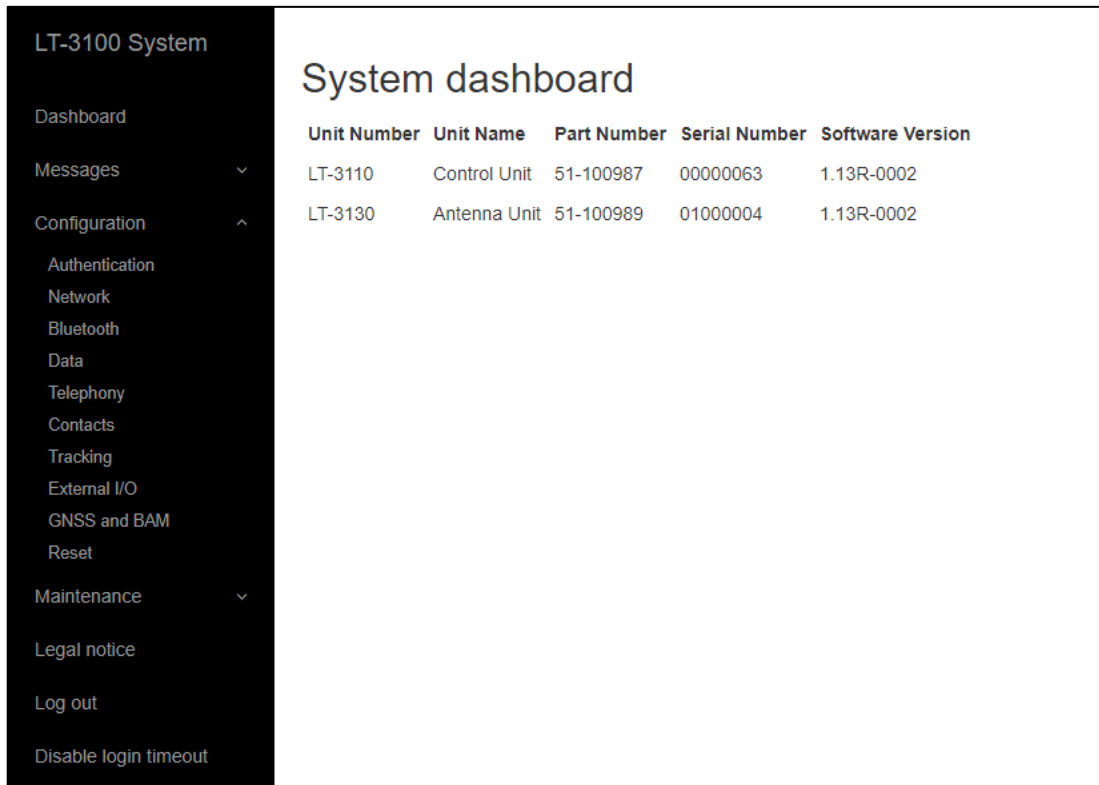

Figure 144: Web server (Configuration)

- Authentication
- Network
- Bluetooth
- Data
- Telephony
- Contacts
- Tracking
- External I/O
- GNSS and BAM
- Reset

Authentication

The LT-3100 system supports configuration of authentication on the web server.

The default password for the User = admin is Password = admin. The LT-3100 system will always be delivered from the factory with this default password.

NOTE: It is recommended that the user of the LT-3100 system changes the default password during the installation of the system, so that a random user on the network do not have access to the web server.

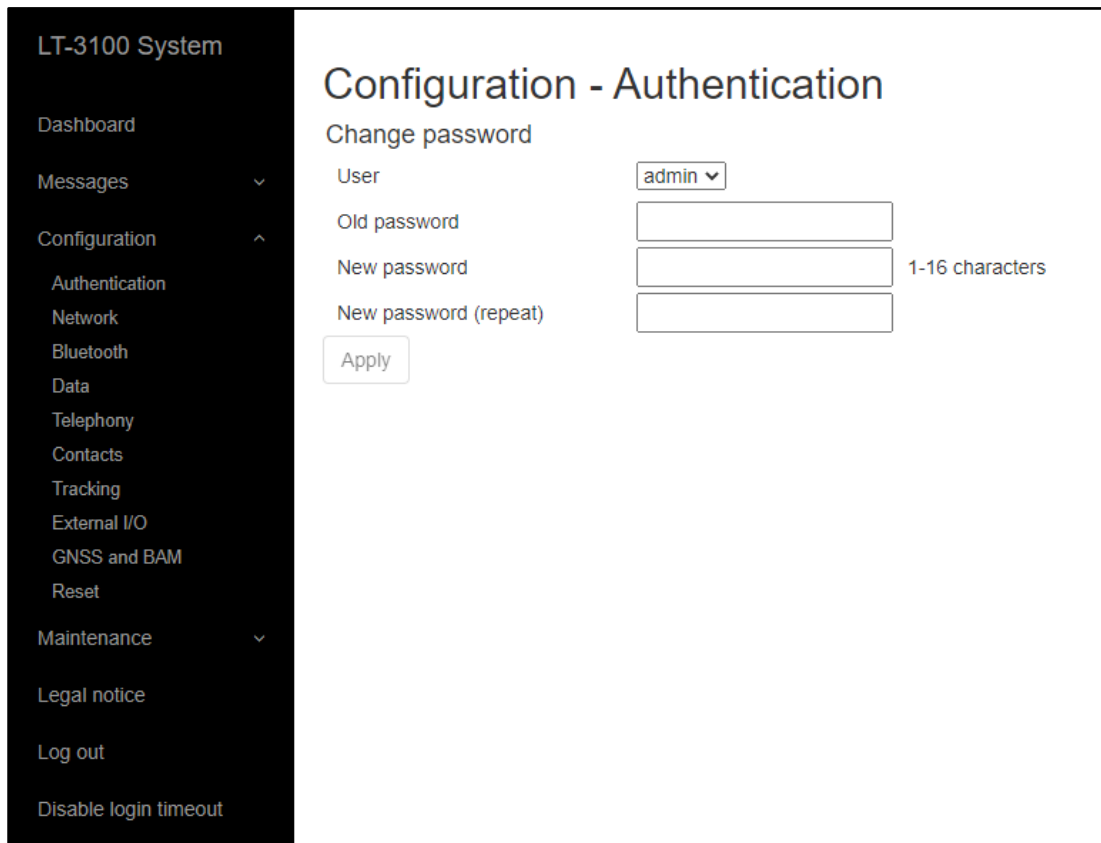

Figure 145: Web server - Authentication

If the authentication password is changed from default and forgotten, then the authentication password can be reset from the display (MENU -> Settings -> Reset Options: Reset Web Authentication). Remember to change the authentication password away from the default password as soon as it has been possible to re-enter the web server. The Reset Web Authentication is further described and illustrated in *Settings* on page 81.

User login

The LT-3100 system supports configuration of a separate web server login named User for the purpose of reading and sending SMS and Email. The User profile is also able to download the diagnostics file. The operator needs to login using the Admin profile to set a password for the User profile, this is displayed on Figure 146.

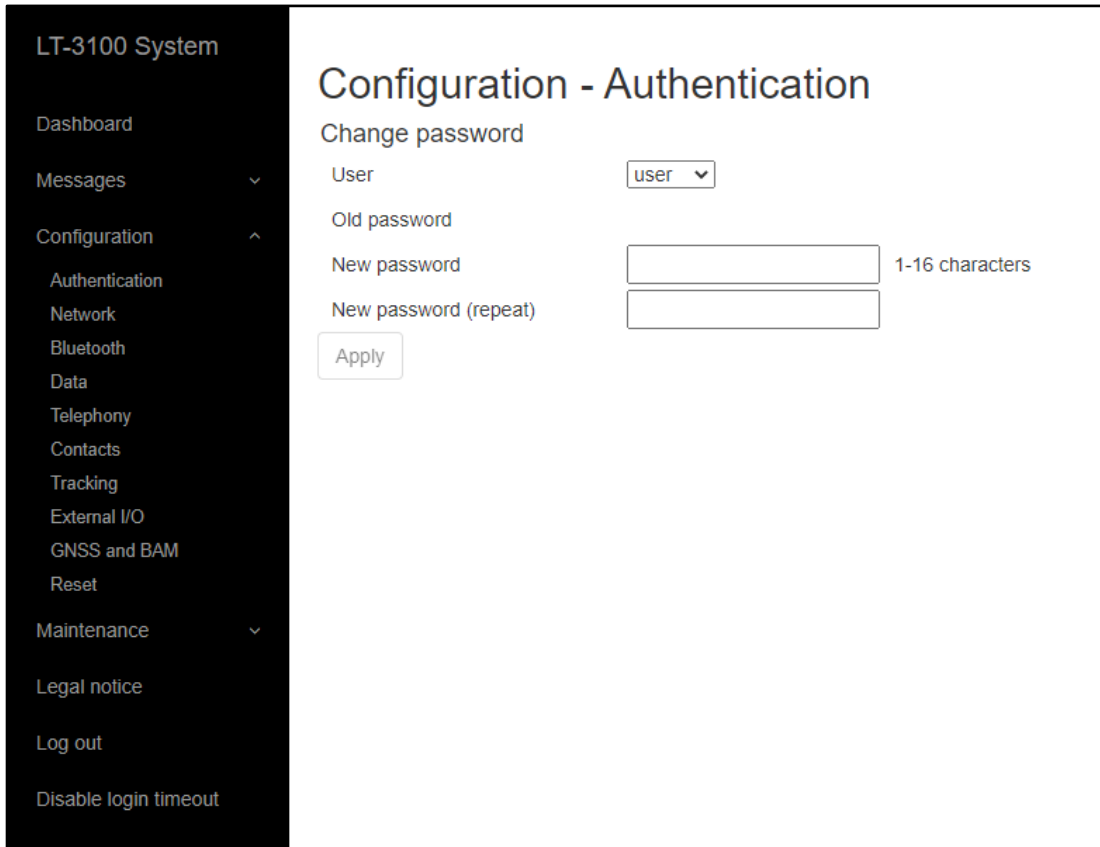

Figure 146: Web server (User login)

After setting the User profile password using the Admin profile, the User profile can be accessed. When logging in using the User profile, only the SMS and Email tabs will be available. From here SMS and Email can be sent and read this is displayed in Figure 147 on page 108.

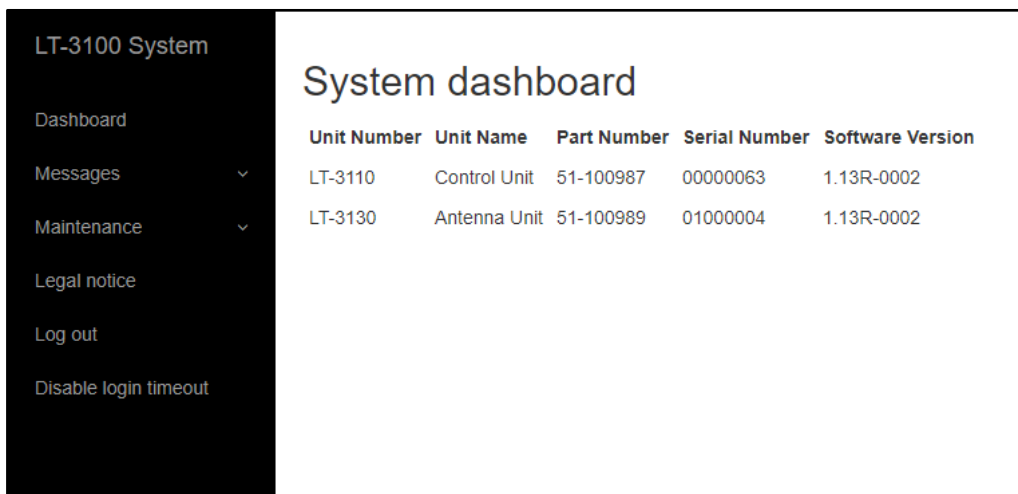

Figure 147: Web server (User login)

NOTE: It is recommended that the installer of the LT-3100 system sets the User profile password during the installation of the system. It is highly recommended to keep the User profile password different from the admin profile password.

Network

The LT-3100 system is supporting the most common network configurations for Local Area Network (LAN). The LT-3100 system has one Ethernet (RJ45) interface, which is described in *Ethernet RJ45 (LAN)* on page 30.

The following network configuration modes will be described in this section:

- DHCP client
- DHCP server
- Static

The default network configuration mode for the Ethernet interface is DHCP client.

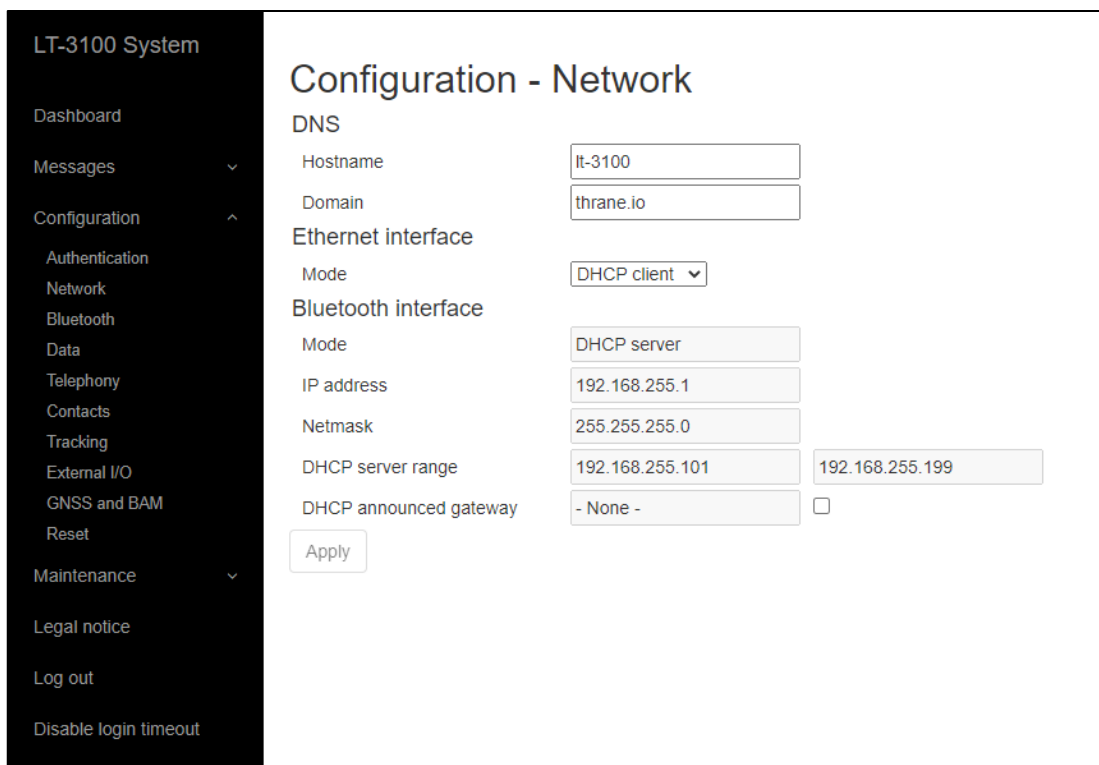

Figure 148: Web server - Network

NOTE: In DHCP client mode, Link-local is supported, in order to connect another ‘passive’ IP-device (e.g. a PC) directly to the LT-3110 Control Unit. Expect the LT-3110 Control Unit to get the IP-address: 169.254.1.1.

NOTE: The IP-address of the LT-3110 Control Unit is always displayed in the UI (MENU -> System -> Network), see details in *System* on page 88

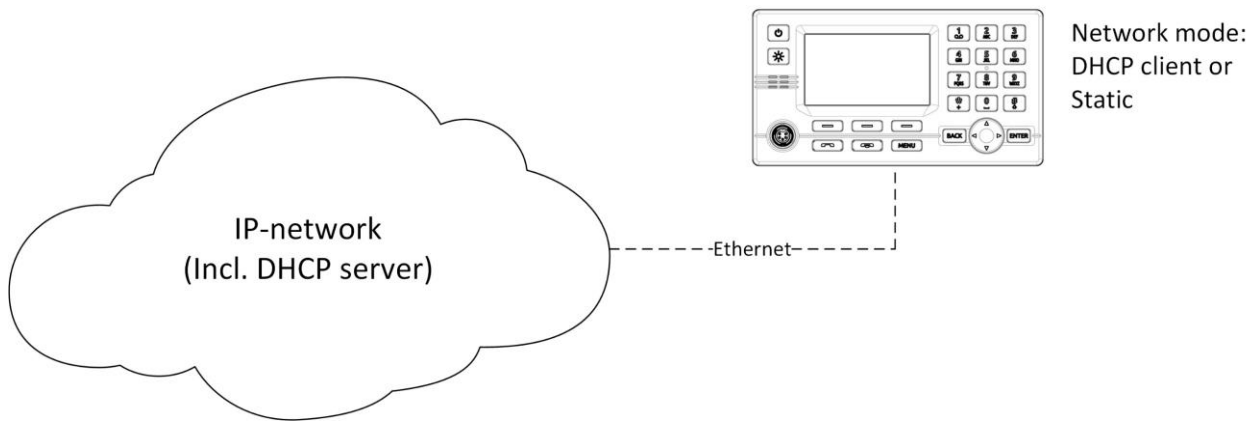

Figure 149: Web server - Network

If the LT-3100 system is connected to a local network as illustrated in Figure 149, where a DHCP server is already available, then the LT-3100 system must be configured to either DHCP client or Static mode. The Static mode can be used, if it is required that the IP-address of the LT-3110 Control Unit must never change.

The LT-3100 system has two reserved network ranges, which are documented in Table 28.

Reserved Network Ranges	
Reserved	Sub-nets
Reserved External	192.168.255.0/24 - i.e. 192.168.255.0 netmask 255.255.255.0
Reserved Internal	172.27.0.0/16 - i.e. 172.27.0.0 netmask 255.255.0.0

Table 28: Reserved Network Ranges

IMPORTANT: Do not connect the LT-3100 System to any external IP networks, which are not trusted. The LT-3110 Control Unit has Firewall rules configured on all Ethernet ports to avoid unwanted IP traffic.

DHCP client

The DHCP client mode is the configuration of the LT-3110 Control Unit from the factory. The DHCP client mode must be used, if the IP network already has a DHCP server available.

DHCP Server

The DHCP server mode must be used when connecting the LT-3110 Control Unit directly to another IP-device or local network, where no DHCP server is offered, and where it is required that a DHCP server is offered for assigning IP-addresses to network clients. The web server DHCP server mode setting is illustrated in Figure 150.

The screenshot shows the 'Configuration - Network' page of the LT-3100 System. On the left is a dark sidebar with navigation options: Dashboard, Messages, Configuration (expanded), Authentication, Network, Bluetooth, Data, Telephony, Contacts, Tracking, External I/O, GNSS and BAM, Reset, Maintenance, Legal notice, Log out, and Disable login timeout. The main content area is titled 'Configuration - Network' and is divided into three sections: DNS, Ethernet interface, and Bluetooth interface. Each section contains input fields for various network parameters. An 'Apply' button is located at the bottom left of the main content area.

Section	Parameter	Value
DNS	Hostname	lt-3100
	Domain	thrane.io
Ethernet interface	Mode	DHCP server
	IP address	192.168.1.1
	Netmask	255.255.255.0
	DHCP server range	192.168.1.100 - 192.168.1.200
	DHCP announced gateway	- None -
Bluetooth interface	Mode	DHCP server
	IP address	192.168.255.1
	Netmask	255.255.255.0
	DHCP server range	192.168.255.101 - 192.168.255.199
	DHCP announced gateway	- None -

Note: if changes are made to DHCP server parameters, this will typically require a restart of clients on the network.

Figure 150: Web server – Network (DHCP server mode)

NOTE: A user scenario for configuration the DHCP server mode is when e.g. connecting IP-based communication devices: Analogue Phone Adapter, SIP Phones, or the RedPort Optimizer directly to the LT-3110 Control Unit via the Ethernet interface. Connecting an Analogue Phone Adapter is further described in *Analogue Phone Adapter* on page 67.

Static

The Static mode must be used when the IP-address of the LT-3100 Control Unit must never change. Typically used, if connecting the LT-3100 Control Unit to an IP-network, where a DHCP server is already available, and where it is important that the IP-address assigned for the LT-3100 Control Unit is never changed.

The screenshot shows the 'Configuration - Network' page of the LT-3100 System web interface. On the left is a dark sidebar menu with options: Dashboard, Messages, Configuration (expanded), Authentication, Network, Bluetooth, Data, Telephony, Contacts, Tracking, External I/O, GNSS and BAM, Reset, Maintenance, Legal notice, Log out, and Disable login timeout. The main content area is titled 'Configuration - Network' and contains the following settings:

- DNS:** Hostname: lt-3100; Domain: thrane.io
- Ethernet interface:** Mode: Static (dropdown); IP address: 192.168.1.1; Netmask: 255.255.255.0; Default gateway: (empty)
- Bluetooth interface:** Mode: DHCP server; IP address: 192.168.255.1; Netmask: 255.255.255.0; DHCP server range: 192.168.255.101 to 192.168.255.199; DHCP announced gateway: - None - (checkbox unchecked)

An 'Apply' button is located at the bottom left of the configuration area.

Figure 151: Web server – Network (Static mode)

NOTE: If the user changes DNS all clients' needs to be rebooted as changes does not apply automatically

Bluetooth

The LT-3100 system has a Bluetooth transceiver built into the LT-3110 Control Unit. The LT-3100 system is currently only supporting the Bluetooth profile: Personal Area Network (PAN), the Headset profile is not supported. It is possible to enable the Bluetooth transceiver and change the device name in the web server, as illustrated in Figure 152.

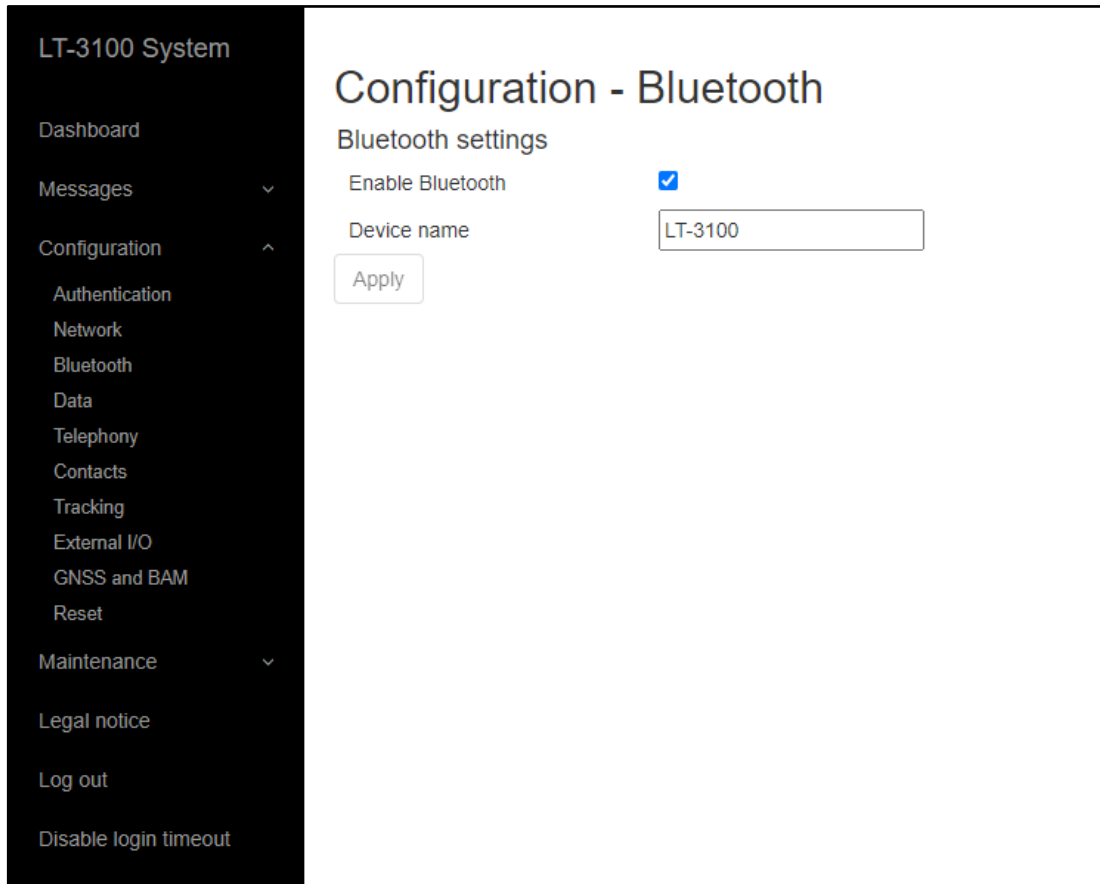

Figure 152: Web server - Bluetooth

Bluetooth information is also available via the UI, which is described in *Settings, Bluetooth* on page 81.

Data

The LT-3100 system is supporting Modem Data (Direct Internet, RUDICS and SBD) services via Serial over Ethernet on the Ethernet (RJ45) or Bluetooth interface. Serial over Ethernet is described in *Ethernet RJ45 (LAN)* on page 30. The Modem Data services are described in *Data (Modem Data, SMS and SBD)* on page 68.

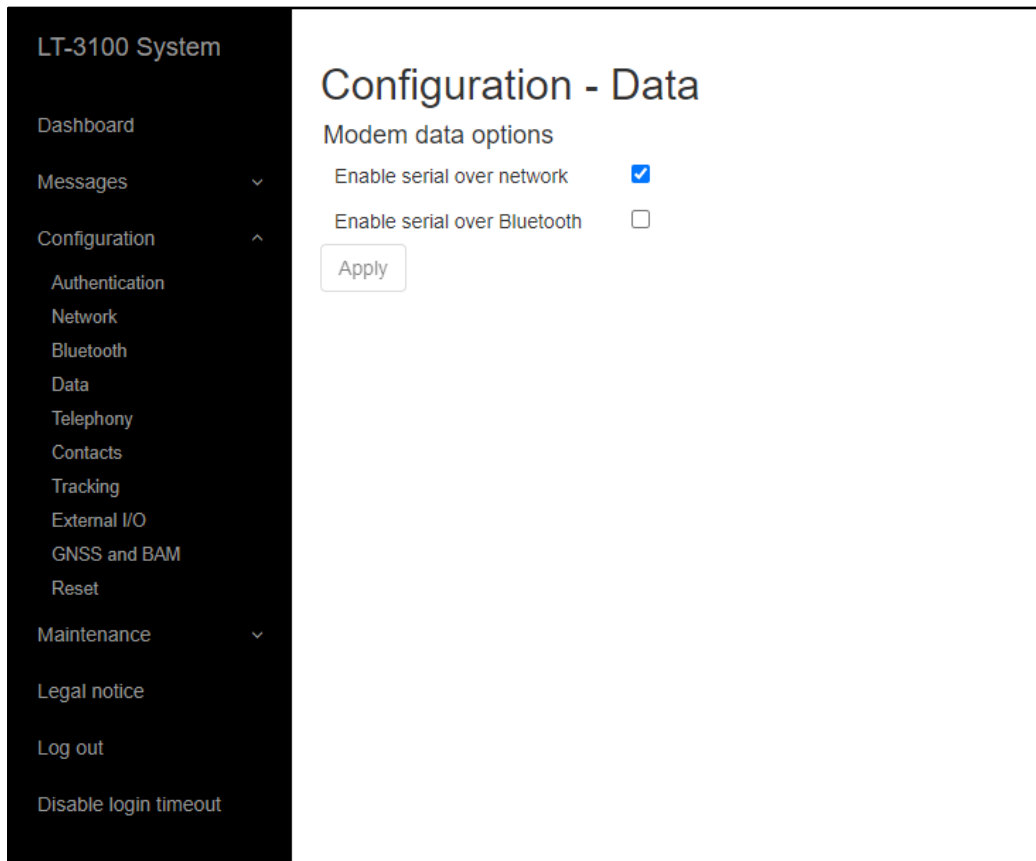

Figure 153: Web server - Data

By activating 'Enable serial over network' the LT-3110 Control Unit will give access to the AT-command interface (port 5020) on the IP-address. The LT-3100 System is supporting Serial over Ethernet (RFC 2217), incl. all the hardware control signals, emulated over the Ethernet interface. It may be required to install a Virtual COM port (e.g., the Serial Port Redirector license) to have an external application work properly utilizing the Modem Data services.

Telephony

The LT-3100 System has a built-in PBX trunk (SIP), which support internal and external satellite calling. The LT-3100 system only supports 1 x Iridium satellite voice channel. The PBX trunk (SIP) can be accessed via Ethernet, RJ45 or via the Bluetooth interface. Up to 8 external SIP devices can be registered in the PBX trunk. The web server, configuration - Telephony is illustrated in Figure 154.

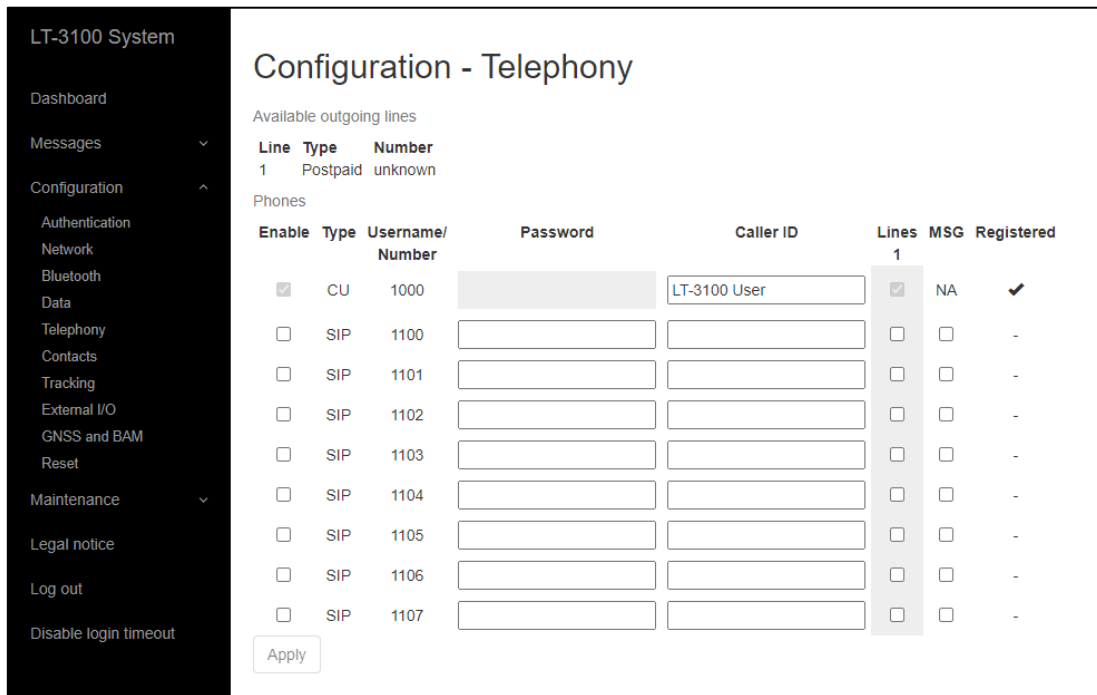

Figure 154: Web server - Telephony

In the LT-3110 Control Unit, UI display (MENU -> System -> SIP Phones) it is possible to get an actual status of the number of SIP devices and their registration status. This is further illustrated and described in *System* on page 88.

The following external applications requires a SIP configuration:

- Connection of ships PBX
- External SIP Phones
- External Analogue Phone Adapter
- SIP Softphones via built-in Bluetooth module
- SIP Softphones via external Wi-Fi Access Point (WAP)

An incoming call to the LT-3100 system, will be signaled to all external SIP devices. The first SIP devices or LT-3120 Handset answering the incoming call will be connected. The LT-3100 system is currently not call forwarding.

Contacts

The user of the LT-3100 system can configure Contacts directly from the web server or from the LT-3110 Control Unit as described in *Phone* on page 77. It is possible to both edit and create new contacts. The web server contact list is identical to the one seen on the LT-3110 Control Unit.

To add a new contact, press the “+” sign, then input: Name, Phone Number and/or Email. When finished inputting information press the Apply button.

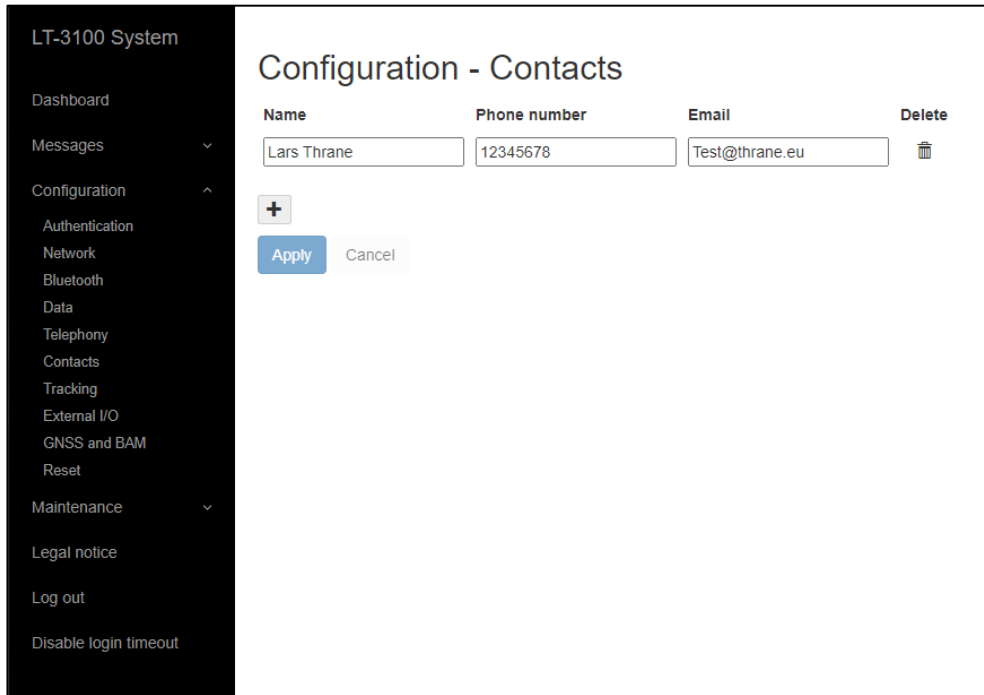

Figure 155: Web server - Telephony

NOTE: It is possible to edit contacts on the Web Server. To do so, edit Name, Phone number or Email address, and then press the Apply button.

Tracking

The LT-3100 system is supporting tracking (position reporting) using different transport types and report formats. This section will briefly describe the different Tracking configurations options. For more details on Lars Thrane A/S tracking protocol supported in the LT-3100 system, please get in contact with Lars Thrane A/S. Figure 156 is illustrating the web server, tracking configuration.

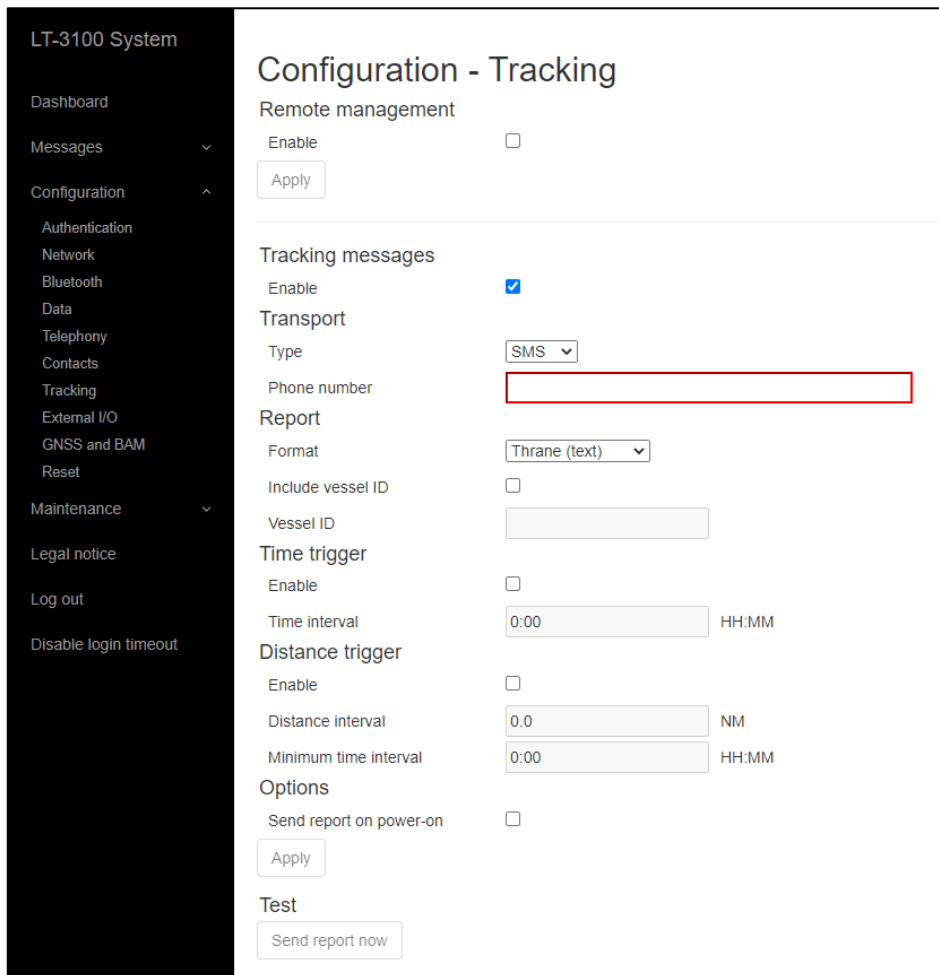

Figure 156: Web server - Tracking

The tracking transport types, and report formats currently supported in the LT-3100 system are summarized in Table 29.

Transport Types & Report Formats		
Transport Type	Report Format	Comments
SBD	Thrane (binary)	Lars Thrane A/S proprietary 10-Bytes binary format
	SIRIUS Track (binary)	Polaris Electronics A/S SIRIUStreck 10-Bytes binary format
SMS	Thrane (text)	Text format to be used for machine reading and decoding
	Human readable	Text format to be used for human reading
Email	Thrane (text)	Text format to be used for machine reading and decoding
	Human readable	Text format to be used for human reading

Table 29: Web server – Tracking (transport types and report formats)

NOTE: Lars Thrane A/S has an Interface Control Document (ICD) with details describing the following content: binary and text formats, remote management (configuration, requesting position report, and trigger position report). In order to support the Thrane (binary) format it is a requirement to get access to this ICD.

The trigger configuration options and intervals are summarized in Table 30.

Trigger Configurations			
Trigger	Format	Interval	Comments
Time			
Time interval	HH:MM	0:01 to 168:00	Time can be configured from 0.01 (1 minute) to 168:00 (up to 7 days)
Distance			
Distance interval	NM	0.1 to 999	Distance can be configured from 0.1 to 999 NM
Minimum time interval	HH:MM	0:01 to 168:00	Minimum time can be configured from 0.01 (1 minute) to 168:00 (up to 7 days)

Table 30: Web server – Tracking (trigger configurations)

The time and distance trigger conditions can be configured individually. A tracking report will be sent, when a trigger condition has been met - time and/or distance. The trigger algorithm will ‘reset’ every time a tracking report has been sent.

The time trigger condition can be configured from 1 minute (0:01) and up to 7 days (168:00). The distance trigger condition can be configured from 0.1 NM and up to 999.0 NM. For the distance trigger condition, it is possible to configure a Minimum time interval, which has the purpose to make sure that not too many tracking reports are sent.

Example: If the distance interval is configured to 5.0 NM and Minimum time interval is configured to 01:00 hour, then position reports will be sent, when both requirements have been met (maximum every 1 hour). If the speed over ground is < than 5 knots, then a tracking report will be sent every 5.0 NM. If the speed over ground is > 5 knots, then a tracking report will be sent every 1 hour.

Under Options - Send report on power-on it is possible to configure the LT-3100 system to send a tracking report every time the terminal is powered on.

Use the button Send report now, illustrated in Figure 156 on page 117, to overwrite the tracking algorithm and send a tracking report instantly. Also, use the button to test the format of the tracking reports after tracking configurations have been applied.

NOTE: The LT-3110 Control Unit UI display has a tracking window (MENU -> System -> Tracking), providing tracking status overview. From this tracking window, it is possible to initiate a periodic tracking report (if configured) or initiate a tracking message, which will be sent to either an SMS or Email destination. For further details see *Tracking* on page 71.

SBD

The LT-3100 system supports the Iridium SBD format, which is ideal, when sending many tracking reports. Using the SBD format requires an additional subscription, which can be activated via an Iridium Service Provider. In order for the Iridium Service Provider to activate the SBD service, the IMEI number of the radio module must be provided. The Iridium Service Provider will configure the SBD subscription and server, routing all SBD messages related to this IMEI number, to a specific address (e.g. Email address of the tracking server).

The IMEI number of the LT-3100 system can be found here:

- LT-3100 system box label
- LT-3130 Antenna Unit Test Sheet
- LT-3110 Control Unit, User Interface display (MENU -> System -> LT-3130 AU -> IMEI)

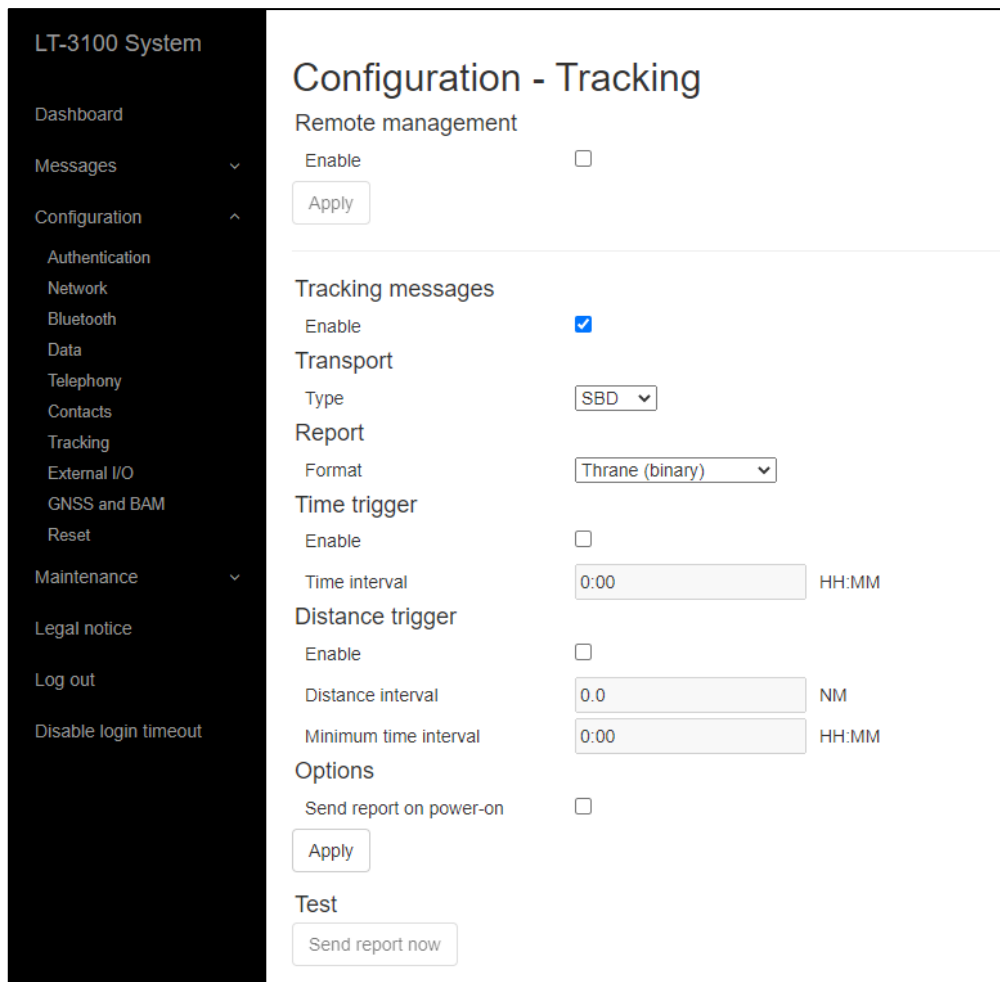

Figure 157: Web server – Tracking (SBD)

The following tracking portals are supporting the SBD (binary formats):

- Thrane (binary) -> TrakSat (www.tracksat.net) IEC telecom
- SIRIUS track (binary) -> SIRIUStrack (www.siriustrack.com) Polaris Electronics A/S

SMS

The LT-3100 system supports SMS as transport type for tracking reports, see configuration options in Figure 158. The SMS tracking is supporting two formats: ‘Thrane (text)’ and ‘Human readable’. Be aware, that sending many tracking reports via SMS will not be the most affordable configuration.

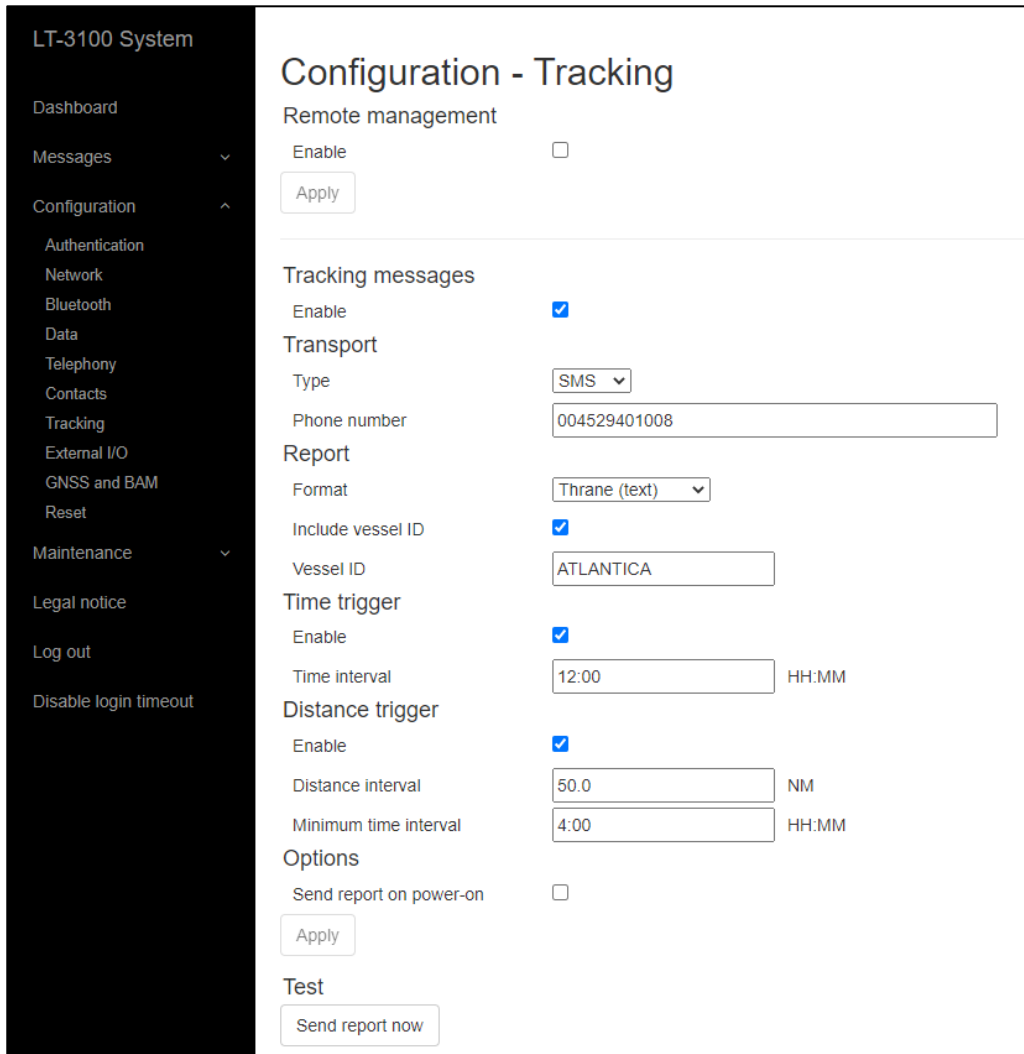

Figure 158: Web server – Tracking (SMS)

The format of a tracking report (SMS - Human readable) sent to e.g. a smartphone is illustrated in Figure 159.

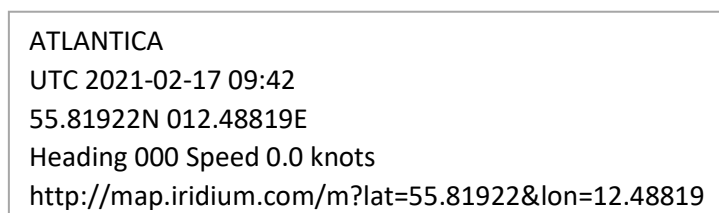

Figure 159: Tracking Report (SMS - Human Readable)

Email

The LT-3100 system supports Email as transport type for tracking reports, see configuration options in Figure 160. The Email tracking is supporting two formats: 'Thrane (text)' and 'Human readable'.

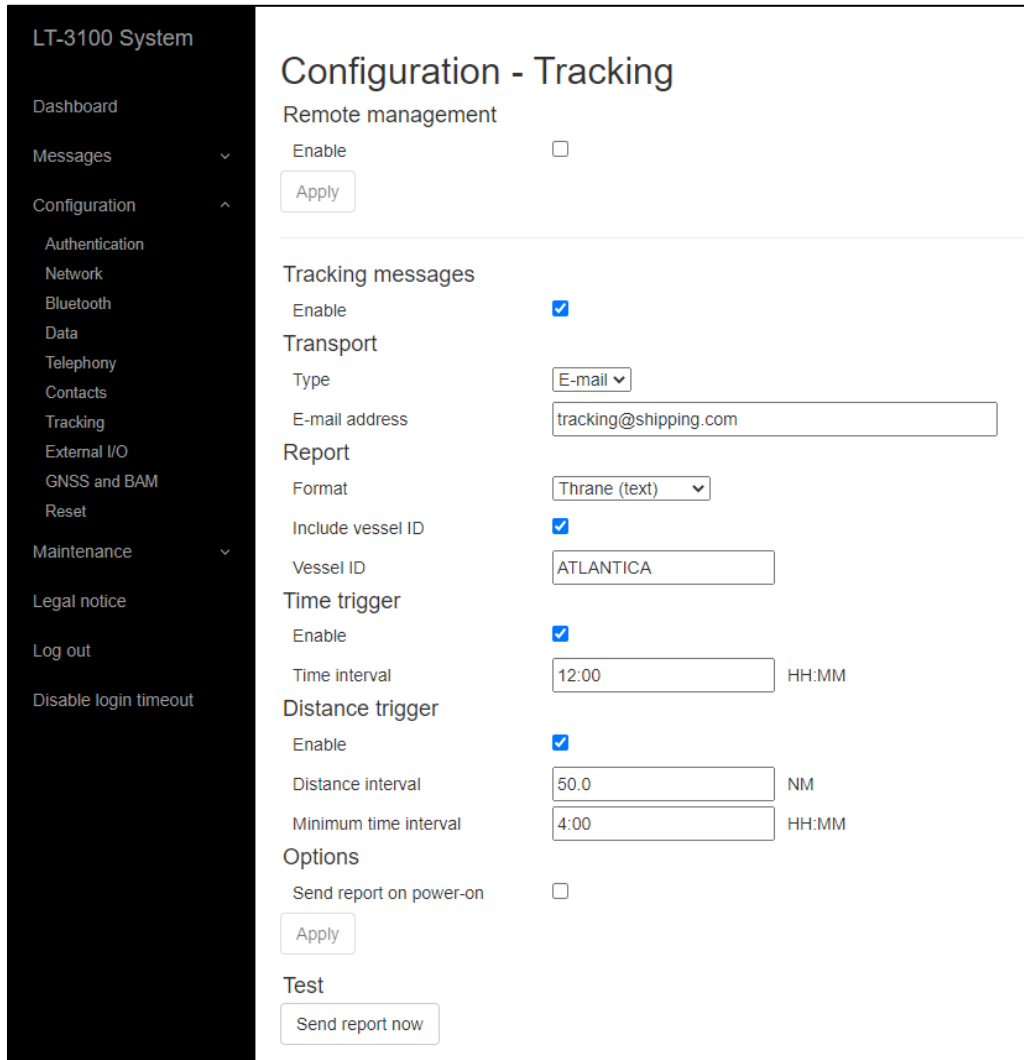

Figure 160: Web server – Tracking (Email)

The format of a tracking report (Email – Thrane (text)) sent to an Email address is illustrated in Figure 161.



Figure 161: Tracking Report (Email – Thrane (text))

Remote Management

The LT-3100 system supports Remote Management for the tracking application. In order for the Remote Management to work, the Remote Management must be enabled by the user and a password must be chosen as illustrated on Figure 162. The Remote Management is using the SMS service as communication layer.

The screenshot shows the 'Configuration - Tracking' page. On the left is a dark sidebar with the following menu items: Dashboard, Messages, Configuration (with an upward arrow), Authentication, Network, Bluetooth, Data, Telephony, Contacts, Tracking, External I/O, GNSS and BAM, Reset, Maintenance (with a downward arrow), Legal notice, Log out, and Disable login timeout. The main content area is titled 'Configuration - Tracking' and has a sub-section 'Remote management'. Under 'Remote management', there is an 'Enable' checkbox that is checked, followed by a 'Password' input field with a placeholder and the text '6-8 alphanumeric characters'. Below the password field is an 'Apply' button. A horizontal line separates this section from the 'Tracking messages' section below. In the 'Tracking messages' section, there is an 'Enable' checkbox that is unchecked, followed by an 'Apply' button.

Figure 162: Web server (Tracking - Remote Management)

The Tracking Remote Management functionality is supporting:

- Request Position Report
- Trigger Position Report
- Change Tracking Configuration

NOTE: For further details about the Remote Management functionality, please contact Lars Thrane A/S.

External – I/O

The LT-3100 system support configuration of External I/O. The LT-3100 system has one input and one output supported in the AUX connector. The AUX connector is described in *Auxiliary (AUX)* on page 31. Figure 163 is illustrating the configuration of the External I/O.

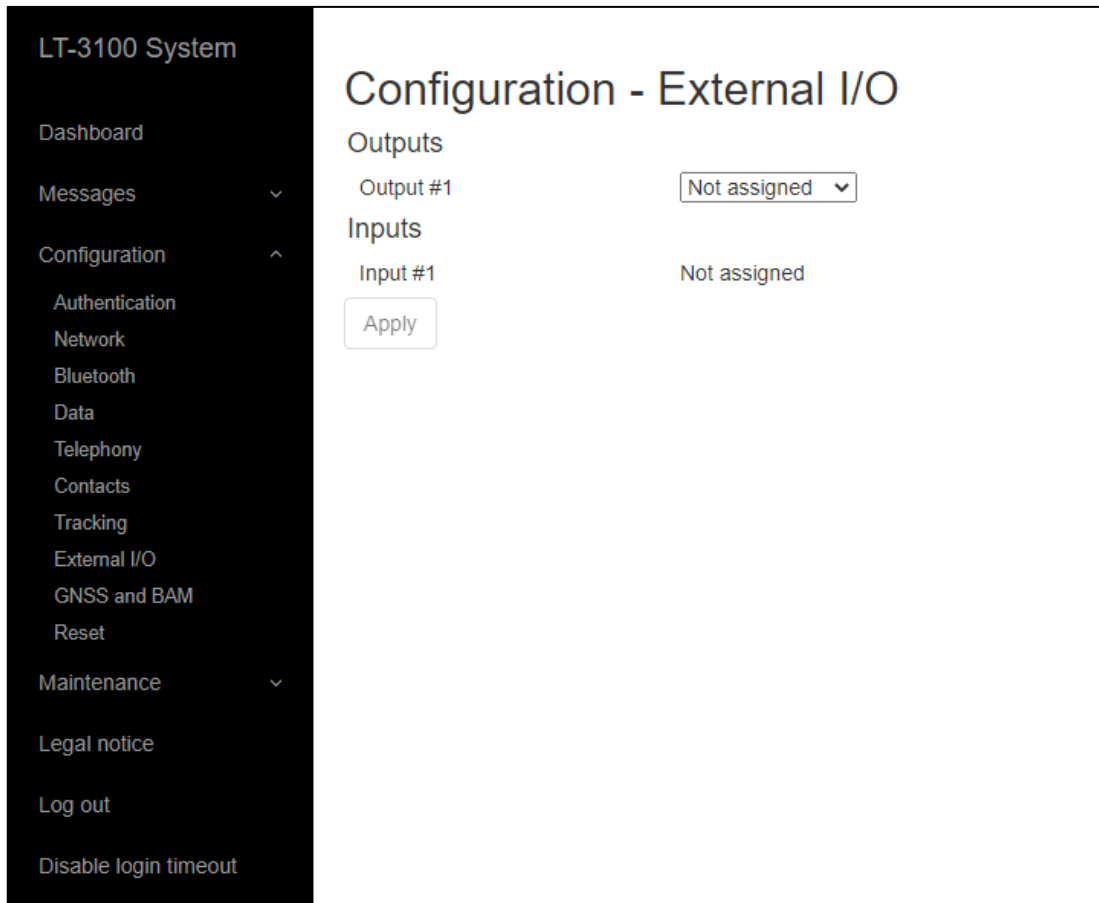

Figure 163: Web server – External I/O

Output

The External I/O output configuration options are listed in Table 31.

External I/O – Output Configuration	
Not assigned	
External Ringer	Level
	Pulse @ 0.5 Hz
	Pulse @ 1 Hz
	Pulse @ 2 Hz

Table 31: External I/O - Output

Input

The LT-3100 system is currently not supporting the External I/O input.

GNSS and BAM

The LT-3100 system has a built-in GNSS receiver located in the LT-3130 Antenna Unit. The GNSS receiver is used for time, date and position of the LT-3100 system, for example by the tracking application. The GNSS receiver can be configured to operate on different satellite systems (e.g. GPS only) - this can be managed under the GNSS module, as illustrated in Figure 164.

It is possible to configure the following functionality: GNSS and BAM on the LT-3110 Control Unit (CU - AUX) interface.

This section describes the following configuration options:

- GNSS module
- GNSS (output of NMEA 0183 sentences)
- Bridge Alert Management (BAM)

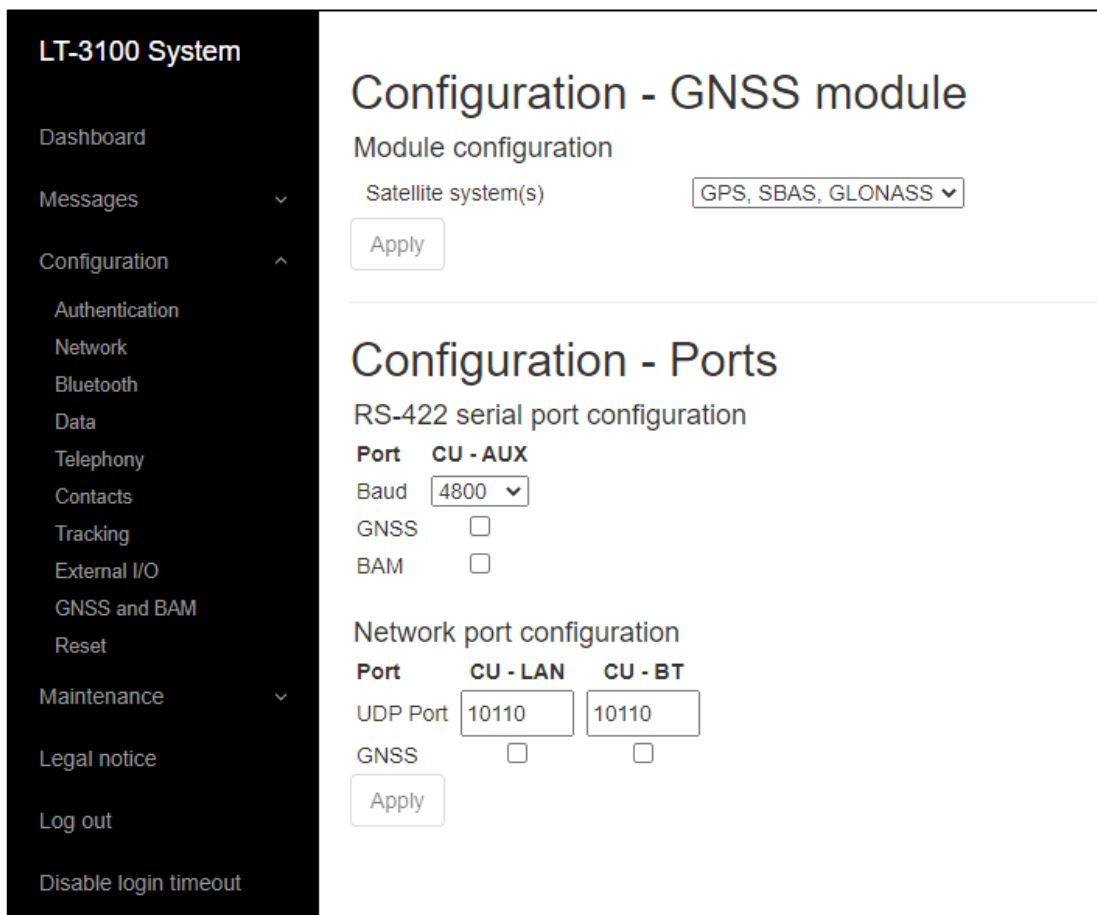

Figure 164: Web server – GNSS and NMEA output

NOTE: The Port configuration illustrated above in Figure 164 for GNSS and BAM supports the following baud rates: 4800, 9600, and 38400. The port is bi-directional RS-422. Only BAM can receive data.

GNSS module

The GNSS receiver used in the LT-3130 Antenna Unit is a 72 ch. receiver with SBAS reception. The GNSS receiver performance is listed in Table 32.

GNSS receiver performance			
Data	Accuracy	Resolution	Comments
Position	GNSS: < 2.5 m SBAS: < 2 m	0.1 m	CEP, 50%, 24 hours static, -130 dBm, > 6 SVs By default, the GNSS receiver is configured for GPS, SBAS, GLONASS reception Time-To-First-Fix (cold acquisition): 26 s.
SOG	0.1 knot	0.1 knot	0 to 195 knots

Table 32: GNSS receiver performance

The GNSS receiver can be configured to the options listed in Table 33. The GPS, SBAS, GLONASS configuration is the default configuration.

GNSS Receiver configuration	
GNSS Receiver	Talker ID
GPS, SBAS, GLONASS	GN
GPS, SBAS, BeiDou	GN
GPS, SBAS	GP
GPS	GP
GLONASS	GL
BeiDou	GB

Table 33: GNSS receiver configuration

The horizontal position accuracy (static) has been measured for different configurations of the GNSS receiver, see Figure 165.

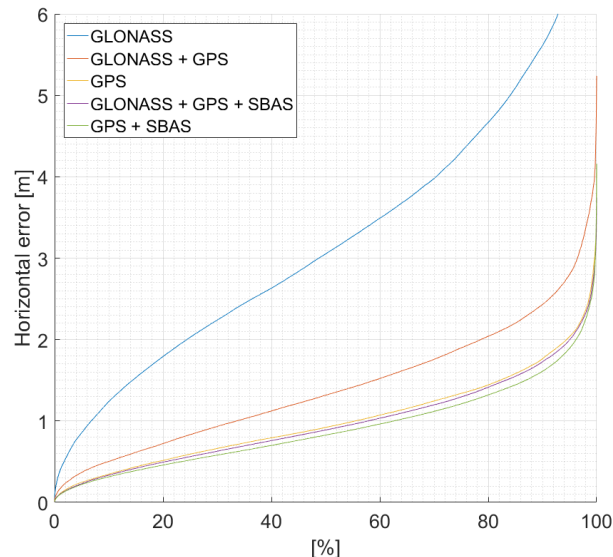

Figure 165: GNSS receiver horizontal position error

IMPORTANT: The installation of the LT-3130 Antenna Unit will affect the performance of the GNSS receiver. If line-of-sight to the GNSS satellites are disturbing the quality of the signal received by the GNSS receiver, then degraded performance must be accepted.

GNSS

The LT-3100 system supports outputting of GNSS NMEA 0183 sentences via the LT-3110 Control Unit AUX (RS-422). The AUX connector is described in detail in *Auxiliary (AUX)* on page 31. The GNSS output must be enabled via the web server, under Configuration – GNSS and BAM. The baud rate can be configured to 4.800, 9.600, or 38.400 baud. The output rate of the NMEA 0183 sentences is 1 Hz. Figure 166 below shows the NMEA 0183 sentences supported by the LT-3100 system.

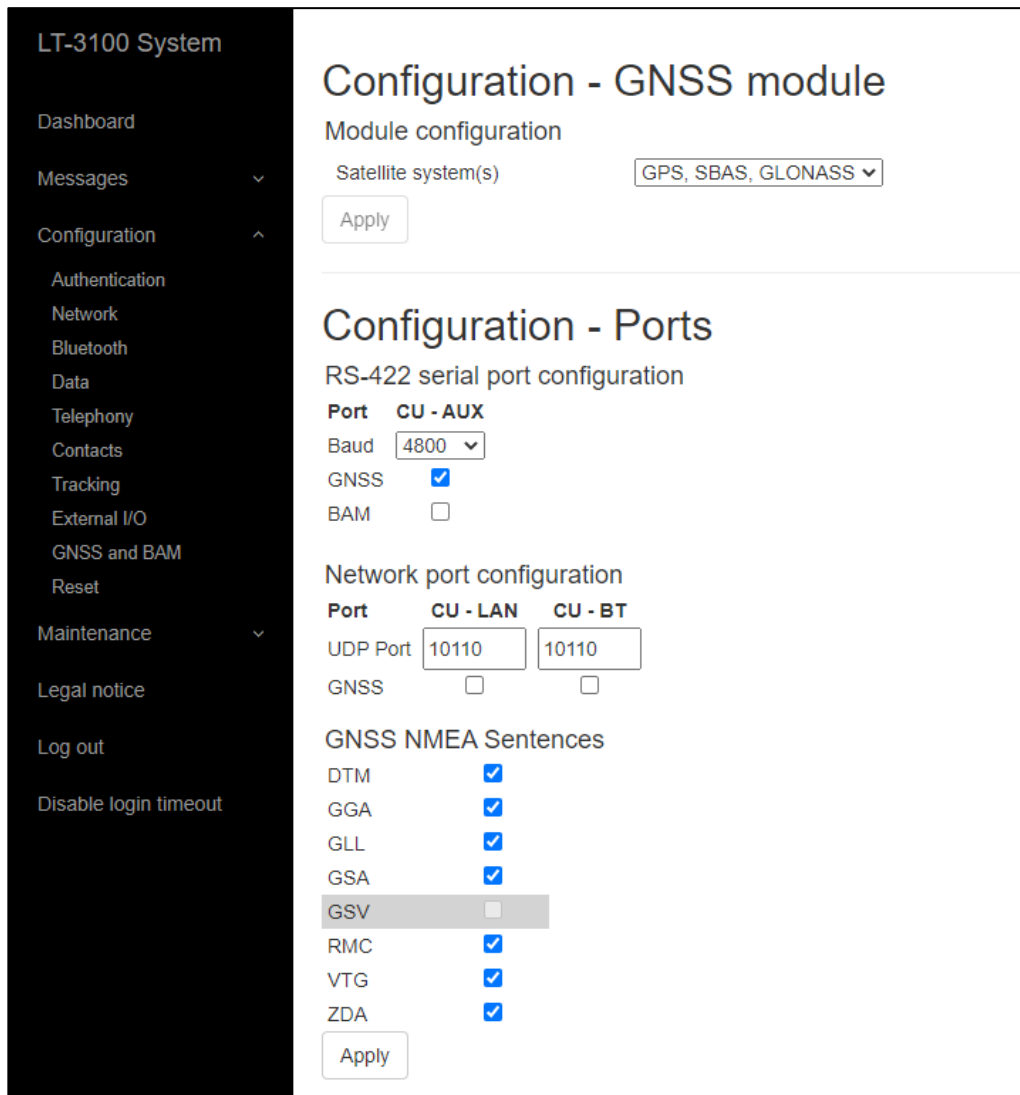

Figure 166: Web server (GNSS - NMEA 0183 sentences)

The GSV sentence is not supported for the 4.800 and 9.600 baud configuration.

NOTE: Changing the GNSS receiver configuration (default: GPS, SBAS, GLONASS) might affect the NMEA 0183 Talker ID. The Talker ID for the different configurations of the GNSS receiver is listed in Table 33 on page 125.

BAM

The LT-3100 system supports BAM via the LT-3110 Control Unit AUX (RS-422) The AUX connector is described in detail in *Auxiliary (AUX)* on page 31. BAM must be enabled via the web server, under Configuration – GNSS and BAM. The baud rate can be configured to 4.800, 9.600, or 38.400 baud. For BAM configuration see Figure 167 below.

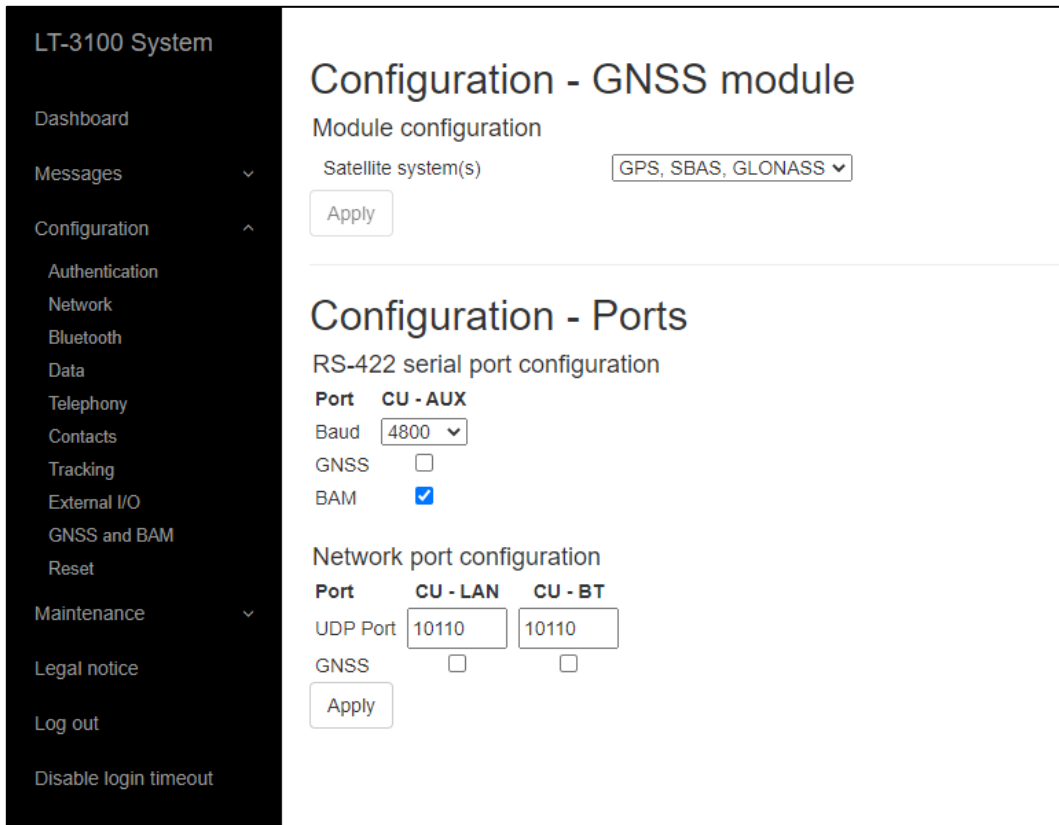

Figure 167: Web server (BAM configuration)

NOTE: The LT-3110 Control Unit AUX connector is providing one bi-directional RS-422 interface.

The Supported BAM sentences are described in *BAM sentences* on page 98.

Reset to factory default

The LT-3100 system supports reset to factory default. This reset functionality is only available via the web server, see Figure 168. By pressing ‘Reset to factory default’ and acknowledging this reset, the LT-3100 system will configure all settings to default and remove all user data (e.g., Contact List, Call History, SMS, etc.). The LT-3100 system will reboot once the factory reset has been affected.

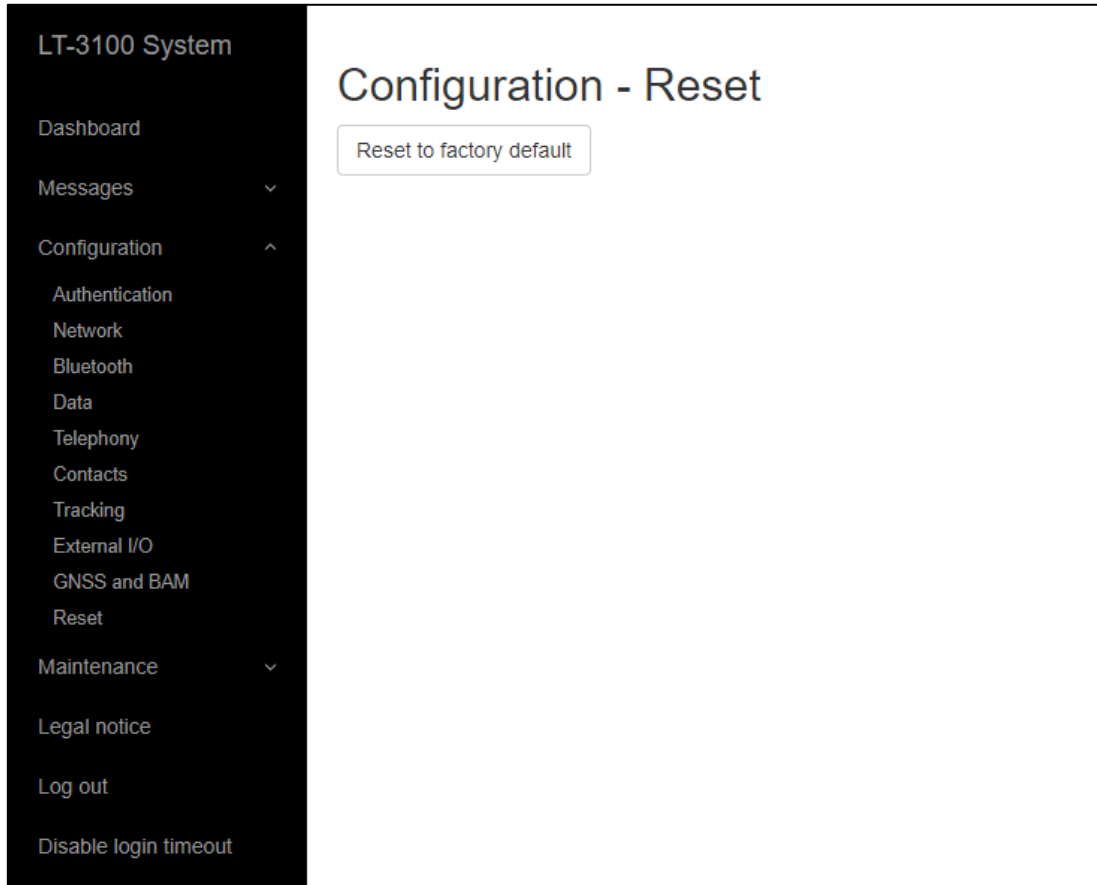

Figure 168: Web server (Reset to Factory Default)

NOTE: Using ‘Reset to factory default’ the LT-3100 system will lose all settings configured and user data will be lost. The system will be operational again once it has rebooted

The default values for display and audio settings are displayed in Table 34 below.

Default Display and Audio settings	
Display, Mode	Day time
Display, Brightness	70%
Speaker volume	80%
Handset volume	60%
Ringer volume	80%
Key Beep volume	40%

Table 34: Default display and audio settings

Maintenance

Diagnostics

A diagnostic report can be downloaded from the webpage 'Diagnostics'. Navigate to the webpage and press the 'Download diagnostics report' button. A file with the following filename (example): LT-3100_00000061_191115-152149.tar.gz will be downloaded to a location selected by the user. The Diagnostics Report can be sent back to Lars Thrane A/S in case of required support and assistance. The Diagnostics Report contains data describing the current state of the system and historical events. The data can be used by support to identify issues and determine their cause.

To help identifying a potential problem with the LT-3100 system it is very important that the Diagnostic Report is sent back to Lars Thrane A/S.

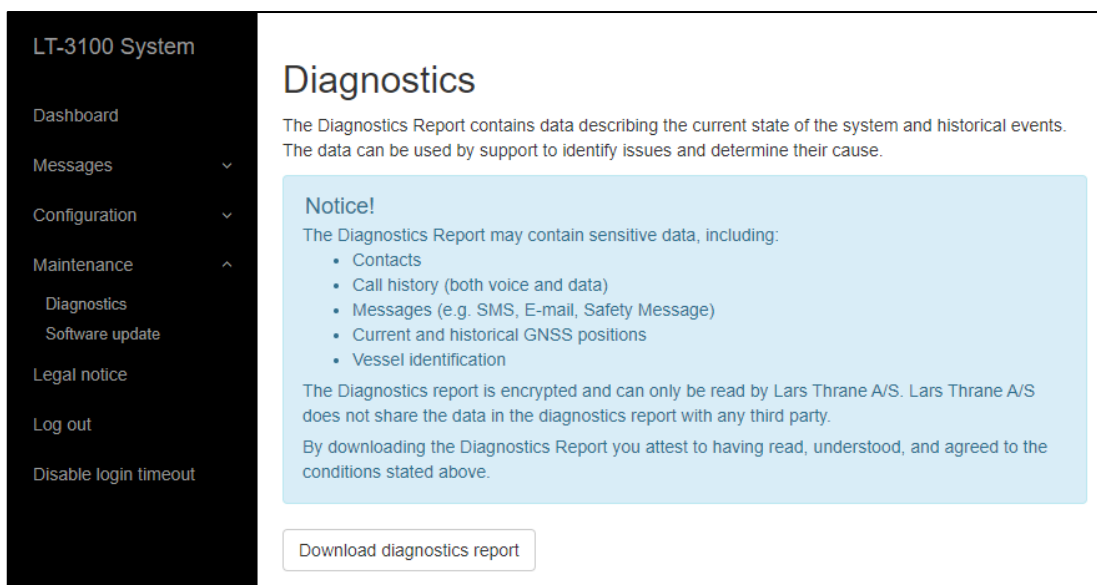

Figure 169: Web server (download diagnostics report)

NOTE: The diagnostic report is encrypted and can only be read by Lars Thrane A/S. Lars Thrane A/S does not share the data in the diagnostics report with any third party. By downloading and sending the diagnostic report to Lars Thrane A/S you attest to having read, understood, and agreed to the conditions stated under the Notice (highlighted in Figure 169 above)!

Software update

Carefully read the software release note, provided by Lars Thrane A/S, before software updating the LT-3100 system.

Access the web server of the LT-3100 system, by following the instructions in *Accessing the built-in web server* on page 101. Select the 'Software update' web page and click the 'Choose File' button to select the LT-3100 system file, which must be uploaded to the system. The software image has the following filename (example): LT-3100-v1.10R-0005.lti - the software image and release documentation will be available on the official company website: <https://www.thrane.eu>, under the specific product or in the Partner Area. Click the 'Upload' button to start the upload of the new software image. The upload and installation of the software image will take a few minutes. Progress indication bars can be monitored on the Software update webpage, while the software update is on-going. The LT-3100 system will reboot once the software image is installed safely in all units.

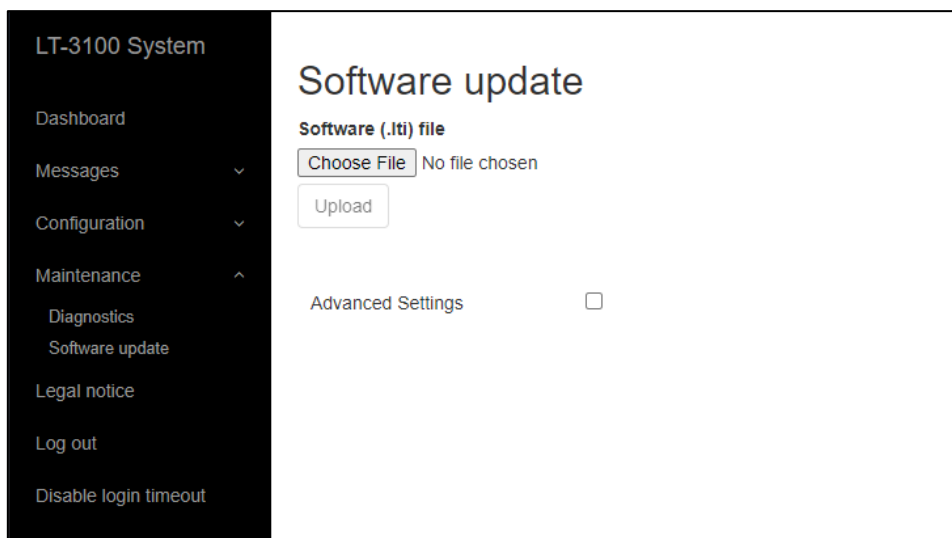

Figure 170: Web server (Software update)

NOTE: The LT-3110 Control Unit and LT-3130 Antenna Unit, must be operated with the same software version. The software update will happen automatically, if the control unit identifies that the software version in the antenna is different. Check or verify the web server Dashboard for software versions in each of the LT-3100 system units, see *Dashboard* on page 102.

IMPORTANT: Do not remove power from the control unit while the software update is on-going. Also, do not disconnect the antenna cable between the control unit and the antenna unit, while the software update is on-going.

IMPORTANT: The Advanced Settings shall not be used under normal circumstances. Do not use this function unless specifically instructed by Lars Thrane A/S or by the Lars Thrane A/S certified partner.

Legal notice

The LT-3100 system contains Open Source software components. The Open Source software components used and related license information can be viewed by pressing the link ‘here’ under the Legal notice webpage, see Figure 171.

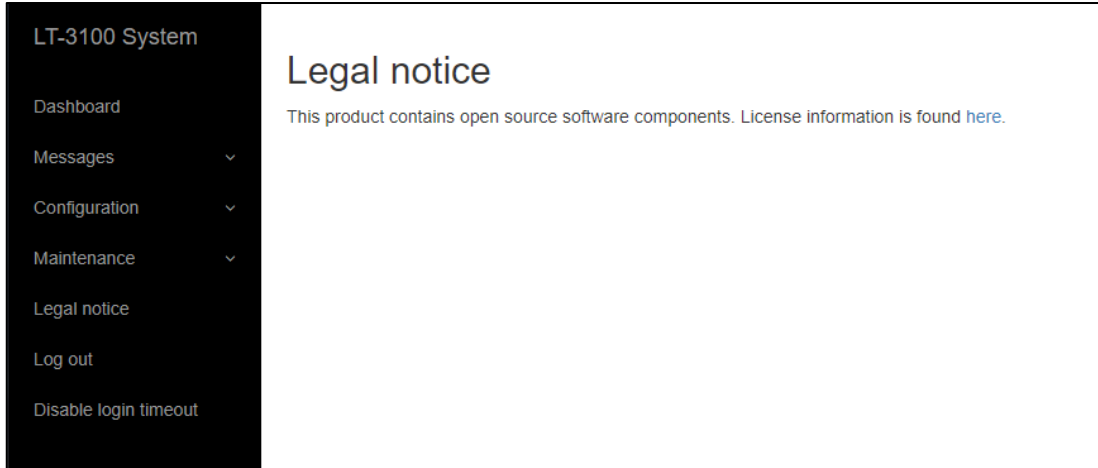

Figure 171: Web server (legal notice)

Log out

By pressing the ‘Log out’ webpage the web server will redirect you to the Authentication login, where it is required to use the Username and Password to re-enter the web server again. The Authentication is described in *Authentication* on page 106.

Disable login timeout

The web server will automatically logout after 5 minutes without activity. The user can disable this automatic logout by pressing the ‘Disable login timeout’ webpage, which then will change to a red color and text: ‘Enable login timeout’. The user must manually remove this configuration by pressing the webpage to go back to default settings and automatically logout.

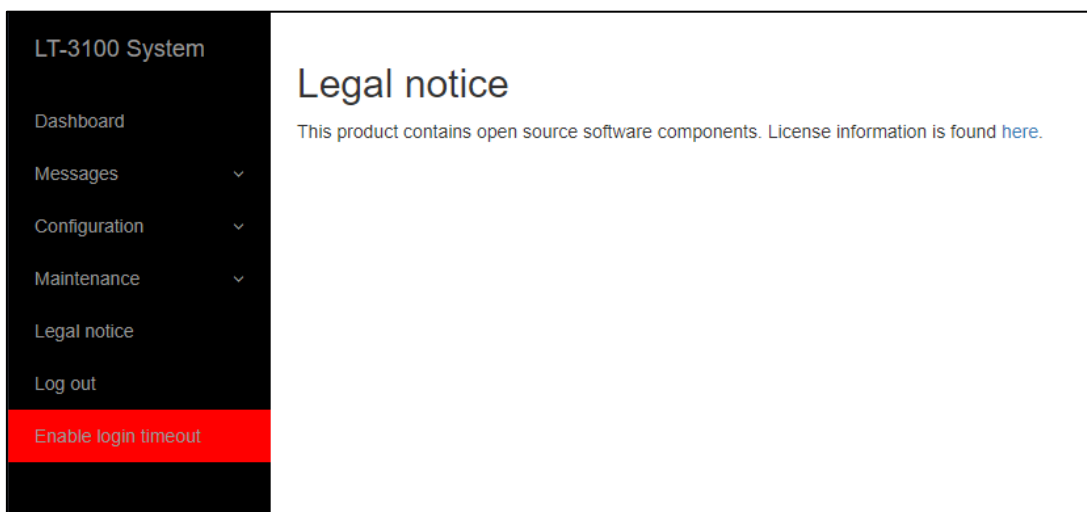

Figure 172: Web server (disable login timeout)

Service & Repair

This section describes what the end-user must do in case of required service or repair.

NOTE: The LT-3100 system does not require any scheduled maintenance or service. Make sure that the product is installed, as described in this manual, before making contact to the distributor or dealer for further assistance.

If the LT-3100 system for some reason does not work as described in this manual, contact the distributor or dealer, from where the product was originally bought. The distributor or dealer will have experience and know-how to assist with further technical support and troubleshooting.

Contacting the distributor/dealer:

- 1) Make sure to have the product name, unit part numbers, and unit serial numbers identified. The unit part numbers, and the unit serial numbers are identified on the unit label, which is found on the backside, or at the bottom side of the units. Alternatively, use the built-in web server to read-out the unit part numbers and the unit serial numbers.
- 2) Write a technical report about the observation or error. If possible, attach a picture of the installed product and include a wiring diagram. If possible, download a diagnostic report as described in *Diagnostic* on page 129.
- 3) Send all information to the local distributor or dealer.

IMPORTANT: Unless otherwise agreed, the end-user shall always coordinate service and repair issues directly with the distributor or dealer. This practice also applies for returning of products for service and repair.

All information that will get back to Lars Thrane A/S, either directly or indirectly, will be handled with confidentiality. End-user sensitive data will not be shared with any third party without prior written acceptance from the involved parties.

Appendixes

App. A - Applicable Standards

- [1] IEC 62923-1
Maritime navigation and radiocommunication equipment and systems - Bridge alert management
Part 1: Operational and performance requirements, methods of testing and required test results
- [2] IEC 62923-2
Maritime navigation and radiocommunication equipment and systems - Bridge alert management
Part 2: Alert and cluster identifiers and other additional features

App. B - Bridge Alert Management (BAM)

Alert generating functions

The LT-3100 system contains the following functions capable of raising

Name	Can be deactivated	Description
GNSS Position	No	The system can be only configured to use either GNSS position (automatic).
SIM	No	Responsible for managing the Subscriber Identity Module (SIM) card. It is not possible to deactivate this function.

Table 35: Alert generating functions

Alert categories

The BAM concept groups alerts into categories as a mean to indicate where an alert may be acknowledged (and thus also whether it can have its responsibility transferred):

Category	Description
A	Alert for which additional information at the alert source is necessary, as decision support for the evaluation of the alert related condition. Alert can only be acknowledged at the alert source.
B	Alert where no additional information for decision support is necessary besides the information which can be presented at the CAM UI. Alert may be acknowledged at the alert source and/or the CAM system.
C	Alert that cannot be acknowledged on the bridge but for which information is required about the status and treatment of the alert.

Table 36: BAM alert categories

List of alerts

ID:	11412	Priority:	Warning	Category:	B	Resp. transfer:	Yes
Title:	Lost handset			Can ACK:	Yes	Transitory:	No
Description:	Voice calls unavailable. Check handset cable						
What to do:	Check the cable between the handset and the Control Unit						
Conditions:	Raised when Control Unit loose connection with the Handset Rectified when connection is reestablished with the Handset.						
Escalation:	Repeated as a warning after 90 s.						

ID:	11412	Priority:	Warning	Category:	B	Resp. transfer:	Yes
Title:	Lost antenna			Can ACK:	Yes	Transitory:	No
Description:	Iridium service unavailable. Check antenna cable						
What to do:	Check the cable between the Control Unit and the Antenna Unit.						
Conditions:	Raised when Control Unit loose connection with the Antenna Unit Rectified when connection is reestablished with the Antenna Unit.						
Escalation:	Repeated as a warning after 90 s.						

ID:	3062	Priority:	Warning	Category:	B	Resp. transfer:	Yes
Title:	System fault			Can ACK:	Yes	Transitory:	No
Description:	System self-check error. Try power-cycle system						
What to do:	Power-cycle the system. If that does not help, contact the service provider.						
Conditions:	Raised when the system self-check detects an unspecified internal error.						
Escalation:	Repeated as a warning after 90 s.						

ID:	3116	Priority:	Caution	Category:	B
Title:	Lost connection				
Description:	Check satellite terminal				
What to do:	Verify the Antenna Unit has free line of sight to the sky. Remove any object blocking the line of sight if possible.				
Conditions:	Raised when the terminal has been unable to detect or otherwise contact the satellites of the Iridium® satellite system for a period of one minute or more. Rectified when the terminal detects the Iridium® satellite system.				

ID:	11402	Priority:	Warning	Category:	B	Resp. transfer:	Yes
Title:	Invalid antenna			Can ACK:	Yes	Transitory:	No
Description:	Incompatible antenna						
What to do:	Replace the Antenna Unit with a compatible one (HW revision >= 2.00).						
Conditions:	Raised when the Control Unit detects an incompatible Antenna Unit revision.						
Escalation:	Repeated as a warning after 90 s.						
Other:	In case of multiple missed calls, only one alert is raised.						

ID:	15102	Priority:	Warning	Category:	B	Resp. transfer:	Yes
Title:	Lost SIM card			Can ACK:	Yes	Transitory:	No
Description:	Check SIM card						
What to do:	Verify the SIM card is properly inserted (see <i>SIM card (SIM)</i> on page 29).						
Conditions:	Raised when the SIM card is removed or cannot be detected. Rectified when the SIM card is detected.						
Escalation:	Repeated as a warning after 90 s.						

App. C - Multiple talkers and multiple listeners

IEC 61162 *Multiple talkers and multiple listeners* is a series of protocol definitions supporting both RS-422 and Ethernet for transporting its messages.

LT-3100 system currently supports IEC 61162 over RS-422 only but is prepared for future support of IEC 61162 over Ethernet. Certification of compliance with IEC 61162-450 and IEC 61162-460 has been obtained and thus the LT-3100 system is permitted to be connected to an IEC 61162 Ethernet network, though none of their functions are supported.

ONF network node

The LT-3100 system is classified as an ONF network node by IEC 61162 using the following protocols: DHCP, IPv4, IPv4LL, UDP, TCP, SIP, RTP, HTTP, HTTPS.

App. D - GNSS sentences

This appendix provides detailed information about the GNSS sentences supported by the LT-3100 system. For further details see *GNSS sentences* on page 97 and web server configuration *GNSS and BAM* on page 124.

GNSS Talker identification mnemonics

The LT-3100 system may use the following talker identifiers:

GNSS Talker Identification Mnemonics		
Talker Device	Identifier	Function
Global Navigation Satellite System (GNSS)	GN	GNSS
Global Positioning System (GPS)	GP	GNSS
GLONASS positioning system	GL	GNSS
BeiDou positioning system	GB	GNSS

Table 37: GNSS Talker identification mnemonics

GNSS Talker Sentence Overview

The table below lists all GNSS sentences the LT-3100 system can transmit (as a talker):

GNSS Talker Sentences			
Sentence Formatter	Function	Description	Transmission Interval
DTM	GNSS	Datum reference	1 s
GGA	GNSS	Global positioning system (GPS) fix data	1 s
GLL	GNSS	Geographic position – latitude / longitude	1 s
GSA	GNSS	GNSS DOP and active satellites	1 s
GSV	GNSS	GNSS satellites in view	1 s
RMC	GNSS	Recommended minimum specific GNSS data	1 s
VTG	GNSS	Course over ground and ground speed	1 s
ZDA	GNSS	Time and date	1 s

Table 38: GNSS Talker Sentences

GNSS Listener sentences overview

No listener sentences available for GNSS.

App. E - BAM Sentences

This appendix provides detailed information about the BAM sentences supported by the LT-3100 system. For further details see *BAM sentences* on page 98 and web server configuration *GNSS and BAM* on page 124.

BAM Talker identification mnemonics

The LT-3100 system may use the following talker identifiers:

BAM Talker Identification Mnemonics		
Talker Device	Identifier	Function
Communications - satellite	CS	BAM

Table 39: BAM talker identification mnemonics

BAM Talker Sentence Overview

The table below lists all BAM sentences the LT-3100 system can transmit (as a talker):

BAM Talker Sentences			
Sentence Formatter	Function	Description	Transmission Interval
ALC	BAM	Cyclic alert list	30 s
ALF	BAM	Alert sentence	n/a
ARC	BAM	Alert command refused	n/a

Table 40: BAM talker sentences

BAM Listener sentences overview

The table below lists all sentences the LT-3100 system can receive (as a listener):

BAM Listener Sentences			
Sentence Formatter	Function	Description	Presence
ACN	BAM	Alert command	Optional
HBT	BAM	Heartbeat supervision sentences	Optional

Table 41: BAM listener sentences

App. F - GNSS Receiver Integrity States

The LT-3100 system has a built-in GNSS receiver located in the LT-3130 Antenna Unit. The GNSS receiver is used under normal conditions for providing the LT-3100 system with time, data, and position information to all required functions in the system. Position Status is located in the System submenu (MENU -> System) described and illustrated in *System* starting on page 88. Table 42 illustrates the GNSS receiver integrity states. The color marking has the following meaning:

- Colored Yellow -> low integrity
- Colored Orange-> Invalid

GNSS Receiver Integrity States (Automatic GNSS)							
State	UTC	POSN	POSN (age)	Horizontal Accuracy	COG [°]	SOG [kts]	Comments
System has just booted and there is not yet a fix	Acquiring...	Acquiring...	-	-	-	-	System booting up
System has just booted and only time is known	Time	Acquiring...	-	-	-	-	System booting up
Horizontal accuracy > 50 m (SOG = 0 kts)	Time	Lat/Long	Up to date	> 50 m	XXX.X	XX.X	System booting up
Horizontal accuracy < 50 m (SOG = 0 kts)	Time	Lat/Long	Up to date	< 50 m	XXX.X	XX.X	Normal GNSS receiver state.
SOG > 1 m/s (~ 2 kts)	Time	Lat/Long	Up to date	< 50 m	XXX.X	XX.X	Normal GNSS receiver state.
GNSS fix completely lost (last known position has age > 0 min)	Time (old)	Lat/Long	> 0 min	-	-	-	No fix on GNSS receiver (time and position).
GNSS fix completely lost (last known position has age 23 hours 59 min)	Time (old)	Lat/Long	≤ 23 hours 59 min	-	-	-	No fix on GNSS receiver (time and position).
GNSS fix completely lost (last known position has age ≥ 24 hours)	Time (old)	Lat/Long Acquiring...	≥ 24 hours	-	-	-	No fix on GNSS receiver (time and position).

Table 42: GNSS Receiver Integrity States (Automatic GNSS)

Table 42 is illustrating the GNSS receiver integrity states .The following pages will illustrate all relevant states.

System has just booted and there is not yet a fix

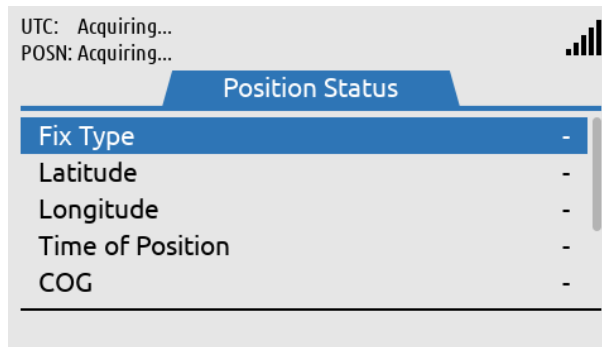

Figure 173: GNSS Receiver Integrity State

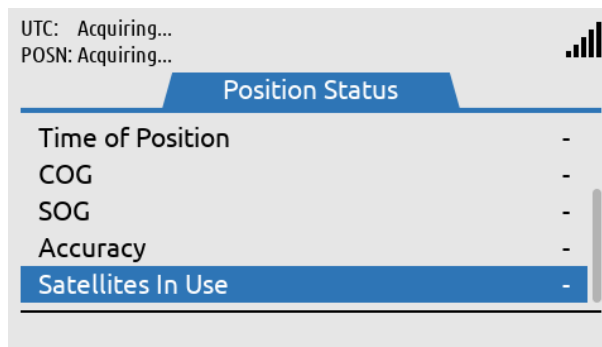

Figure 174: GNSS Receiver Integrity State

System has just booted and only time is known

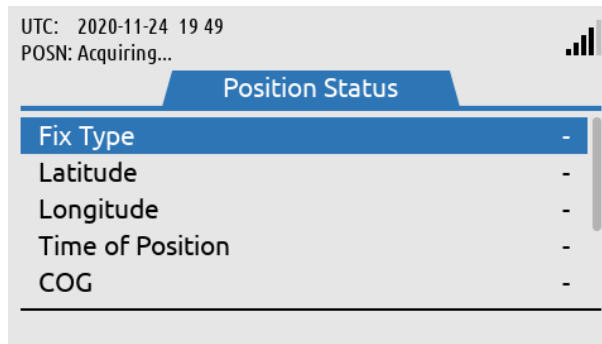

Figure 175: GNSS Receiver Integrity State

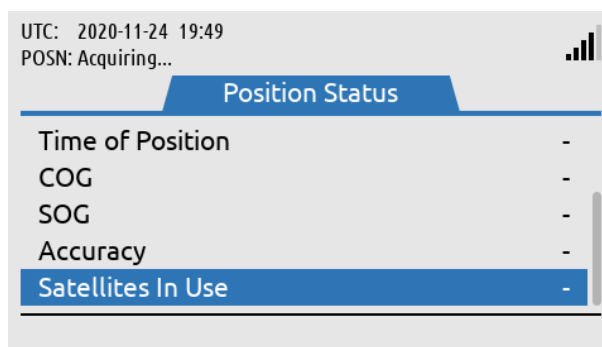

Figure 176: GNSS Receiver Integrity State

Horizontal accuracy > 50 m (SOG = 0 kts)

UTC: 2020-11-24 19:44		📶
POSN: 55°49.151N 012°29.291E		
Position Status		
Fix Type	3D + DGNSS	
Latitude	55°49.151N	
Longitude	012°29.291E	
Time of Position	2020-11-24 19:44	
COG	153.6°	

Figure 177: GNSS Receiver Integrity State

UTC: 2020-11-24 19:44		📶
POSN: 55°49.151N 012°29.291E		
Position Status		
Time of Position	2020-11-24 19:44	
COG	153.6°	
SOG	0.0 knots	
Accuracy	< 100.0 m	
Satellites In Use	21	

Figure 178: GNSS Receiver Integrity State

Horizontal accuracy < 50 m (SOG = 0 kts)

UTC: 2020-11-24 19:53		📶
POSN: 55°49.152N 012°29.291E		
Position Status		
Fix Type	3D + DGNSS	
Latitude	55°49.152N	
Longitude	012°29.291E	
Time of Position	2020-11-24 19:53	
COG	153.6°	

Figure 179: GNSS Receiver Integrity State

UTC: 2020-11-24 19:53		📶
POSN: 55°49.152N 012°29.291E		
Position Status		
Time of Position	2020-11-24 19:53	
COG	153.6°	
SOG	0.0 knots	
Accuracy	< 0.8 m	
Satellites In Use	20	

Figure 180: GNSS Receiver Integrity State

SOG > 1 m/s (~ 2 kts)

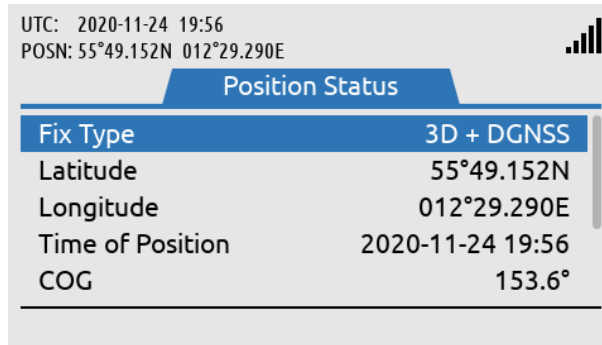

Figure 181: GNSS Receiver Integrity State

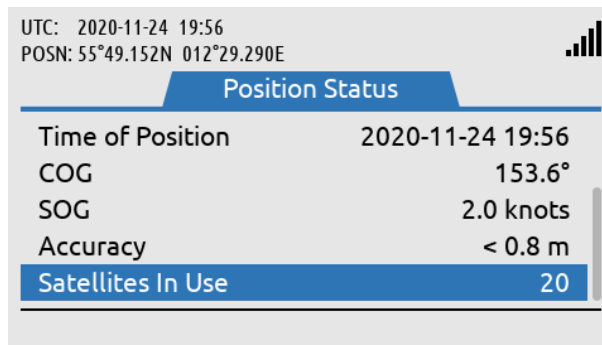

Figure 182: GNSS Receiver Integrity State

GNSS fix completely lost (last known position has age 10 min)

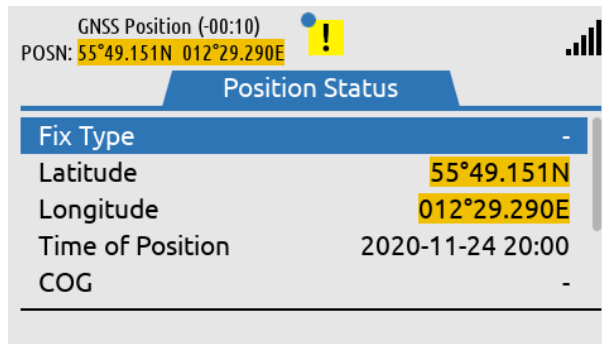

Figure 183: GNSS Receiver Integrity State

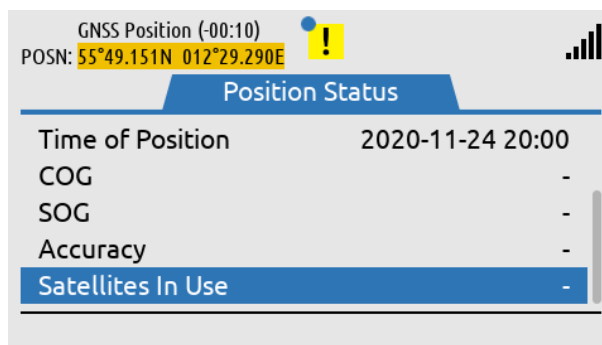

Figure 184: GNSS Receiver Integrity State

GNSS fix completely lost (last known position has age 23 hours 59 min)

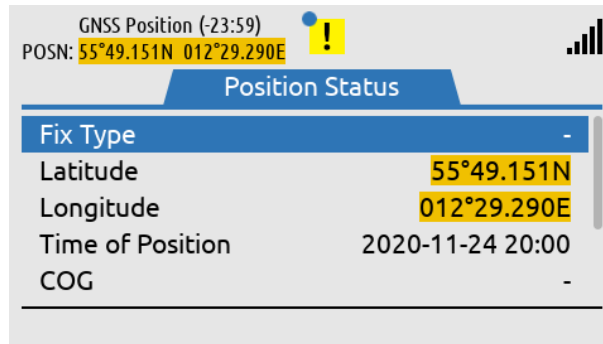

Figure 185: GNSS Receiver Integrity State

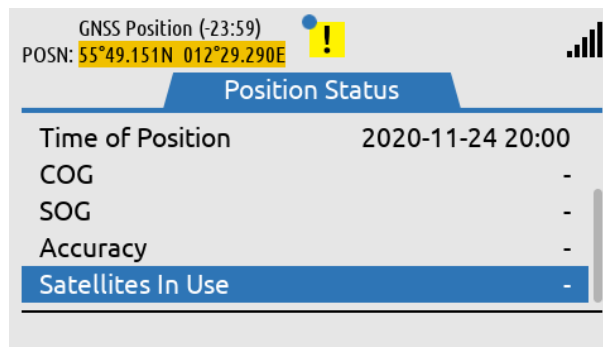

Figure 186: GNSS Receiver Integrity State

GNSS fix completely lost (last known position has age >= 24 hours)

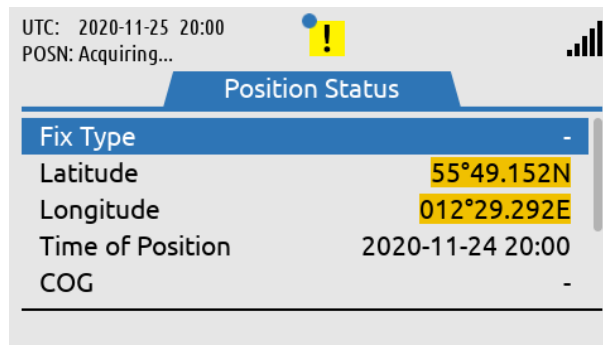

Figure 187: GNSS Receiver Integrity State

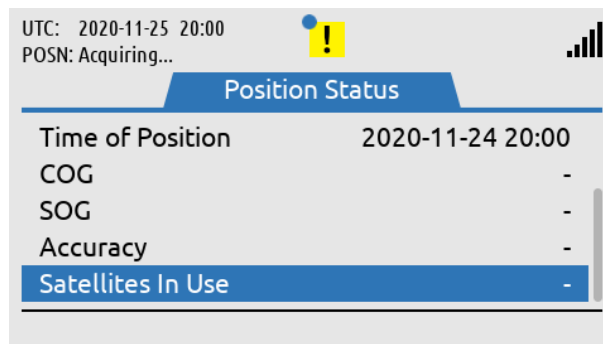

Figure 188: GNSS Receiver Integrity State

App. G - Specifications**LT-3100 Satellite Communications System**

Certification & standards	Maritime CE, RED, ISED, FCC, RCM, RoHS, Iridium®
Vibration, operational	IEC 60945 (sine) & proprietary Maritime Random profile
Vibration, survival	Proprietary Maritime Random profile
Vibration, shock	Proprietary Maritime profile (20 g, 11 ms)
Power consumption: operating mode, max	40.8 W
Power consumption: Idle	9 W

LT-3110 Control Unit

Weight	658 g (1.45 lbs)
Dimensions	224.0 x 120.0 x 70.0 mm (8.82 x 4.72 x 2.76 in)
Temperature, operational	-15°C to +55°C (+5°F to +131°F)
IP rating, dust and water	IP 32
Interfaces	Ethernet, auxiliary, DC input, chassis ground Antenna Unit (N conn.), handset, Bluetooth, SIM card
Input voltage	12 - 24 VDC
BT transmitter, Max RF output power	10mW
BT transmitter, Frequency bands	TX: 2402-2480MHz, RX:2402-2480MHz
Compass Safe Distance, std.	0.60 m (2.0 ft)
Compass Safe Distance, steer.	0.40 m (1.3 ft)

LT-3120 Handset

Weight	290 g (0.64 lbs)
Dimensions	208.8 x 52.8 x 38.2 mm (8.22 x 2.08 x 1.50 in)
Temperature, operational	-15°C to +55°C (+5°F to +131°F)
IP rating, dust and water	IP32
Compass Safe Distance, std.	0.60 m (2.0 ft)
Compass Safe Distance, steer.	0.35 m (1.1 ft)

LT-3121 Cradle

Weight	66 g (0.15 lbs)
Dimensions	106.9 x 57.4 x 29.3 mm (4.21 x 2.26 x 1.15 in)
Compass Safe Distance, std.	1.40 m (4.6 ft)
Compass Safe Distance, steer.	0.90 m (3.0 ft)

LT-3130 Antenna Unit (HVIN = 2)

Weight	687 g (1.51 lbs)
Dimensions	151.1 x Ø 149.5 mm (5.95 x Ø 5.89 in)
Temperature, operational (12 VDC input power)	-30°C to +55°C (-30°F to +131°F)
Temperature, operational (24 VDC input power)	-40°C to +55°C (-40°F to +131°F)
IP rating, dust and water	IP67
Interfaces	Control Unit (N conn.)
Antenna communication cable	Coaxial cable, up to 500m (1500 ft)
Compass Safe Distance, std.	0.30 m (1.0 ft)
Compass Safe Distance, steer.	0.30 m (1.0 ft)

Warranty	2 years
Maintenance	None

App. H - Outline Drawing: LT-3110 Control Unit

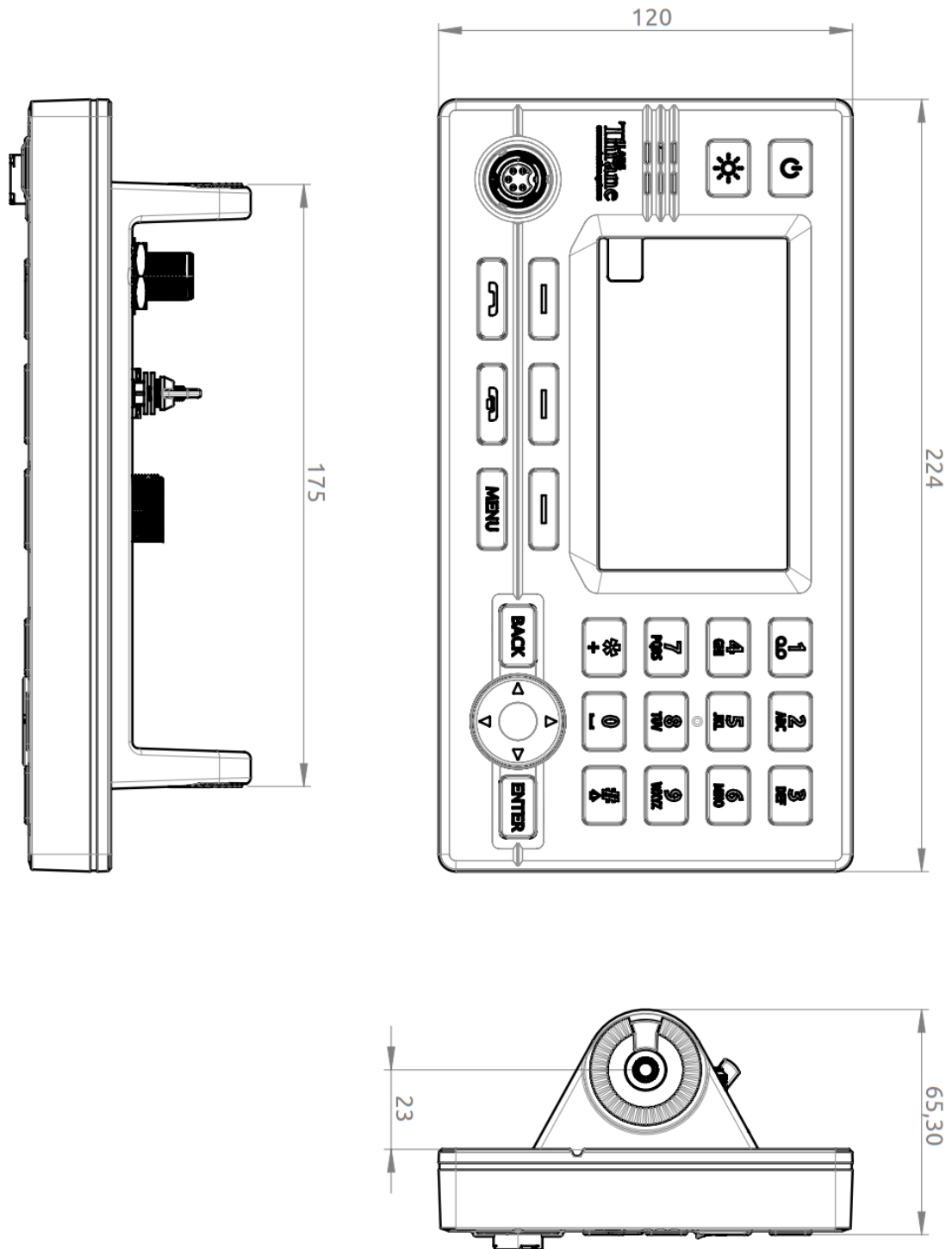

Figure 189: Outline Drawing: LT-3110 Control Unit

App. I - Outline Drawing: Bracket Mount, Control Unit

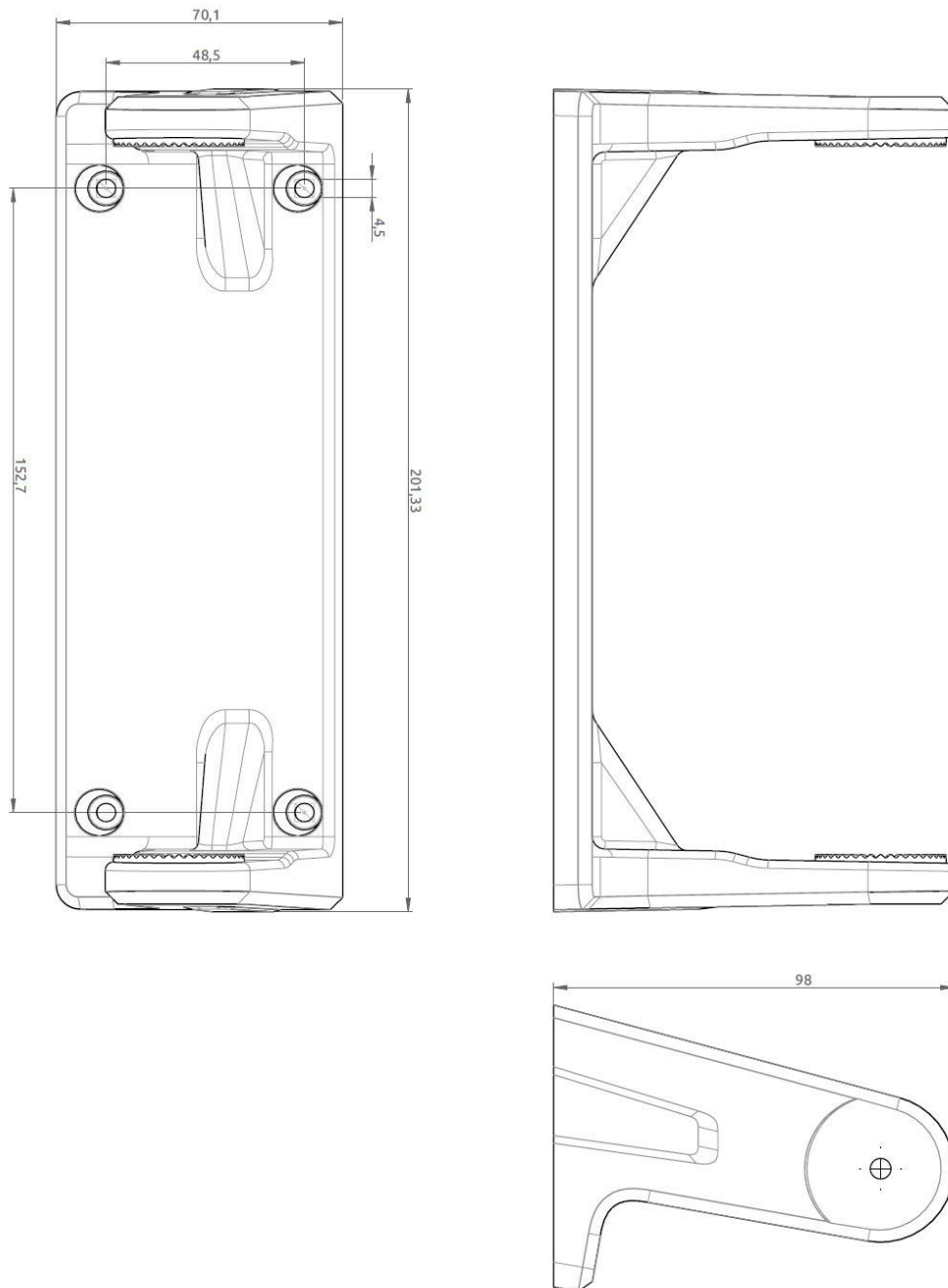

Figure 190: Outline Drawing: Bracket Mount, Control Unit

App. J - Outline Drawing: Flush Mount, Control Unit

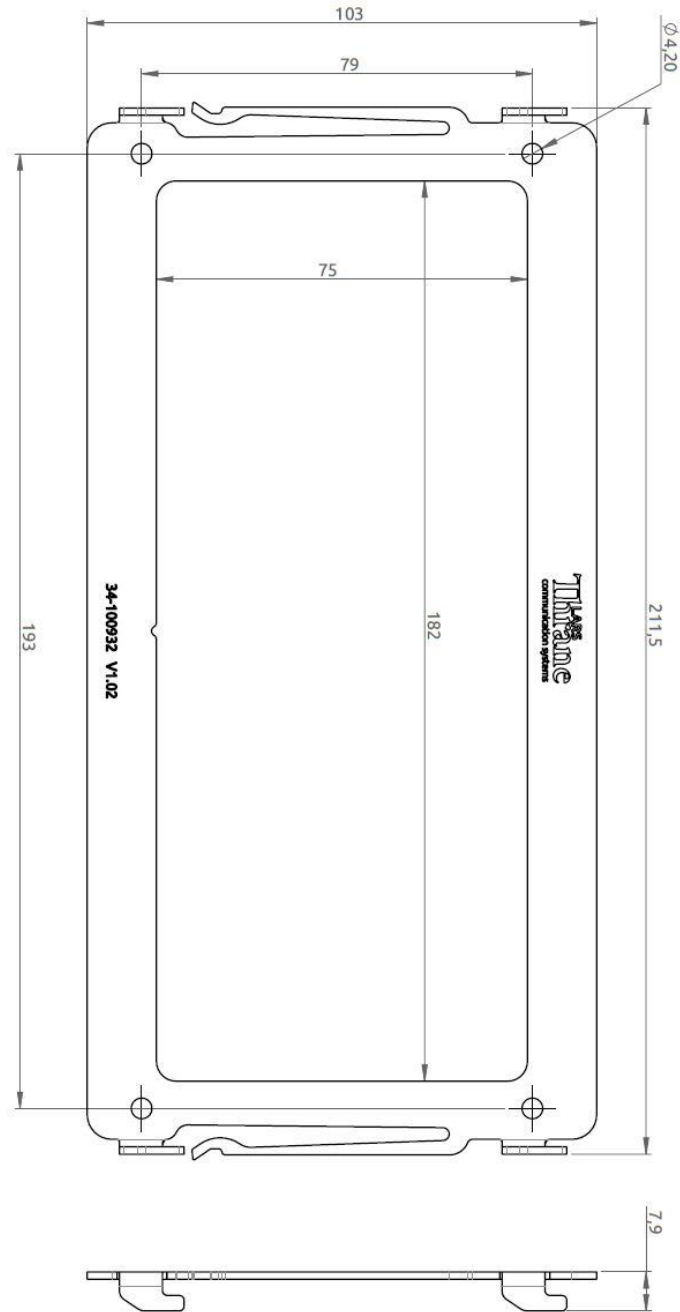

Figure 191: Outline Drawing: Flush Mount, Control Unit

App. K - Outline Drawing: LT-3130 Antenna Unit

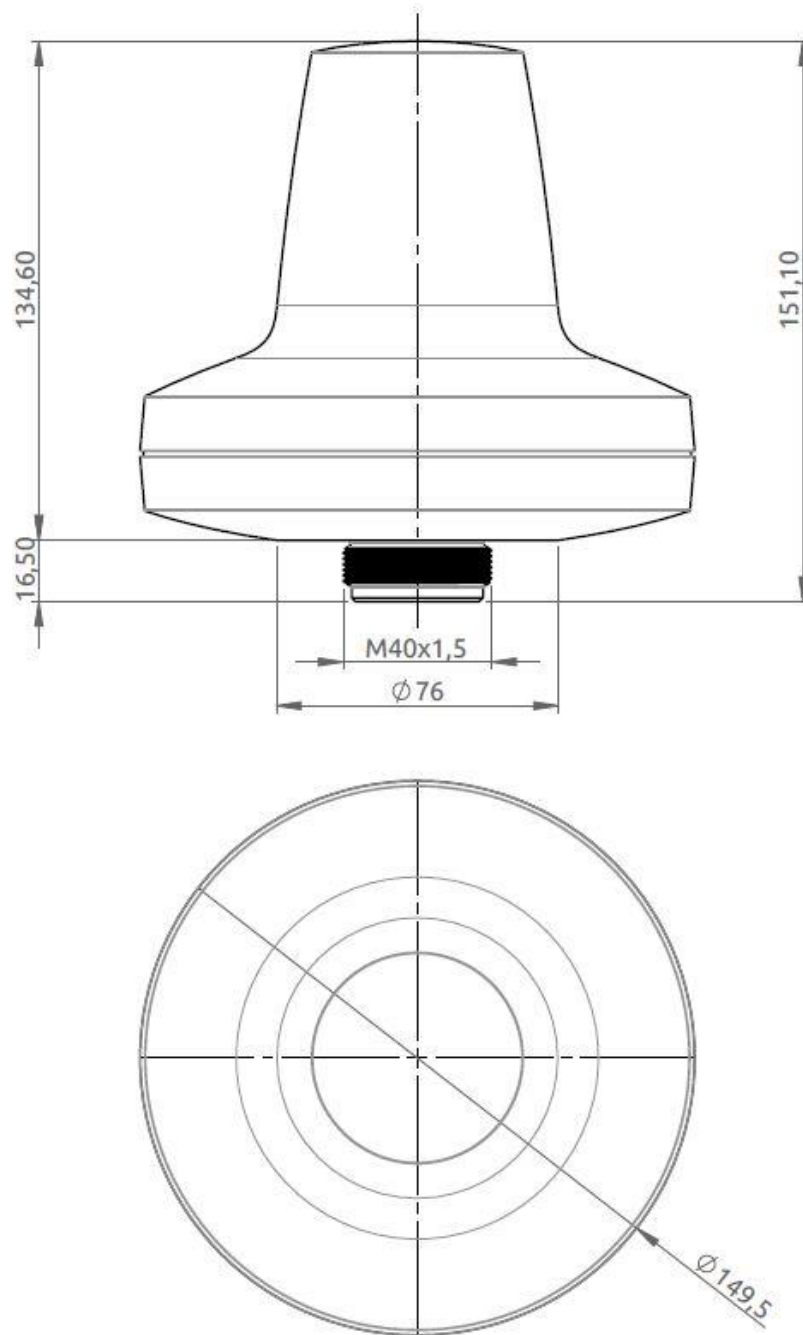

Figure 192: Outline Drawing: LT-3130 Antenna Unit

App. L - Outline Drawing: Pole Mount (1.5" pipe, 38.8mm), Antenna Unit

NOTE: The Pole Mount (1.5" pipe), Antenna Unit interfaces to a pipe of maximum 1.5" (38.1 mm), measured outer diameter. The total weight of the Pole Mount is 190 g (0.42 lbs).

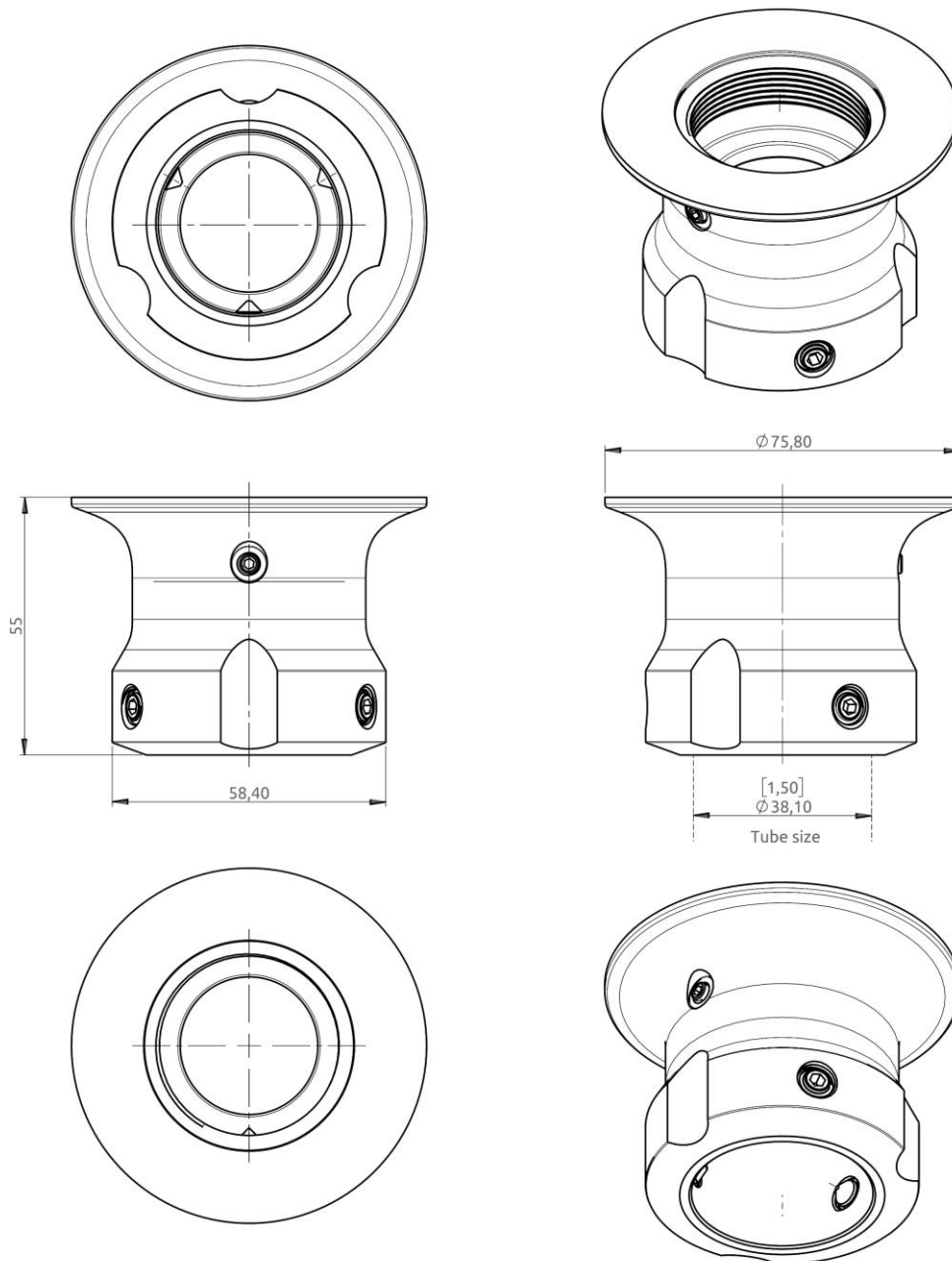

Figure 193: Outline Drawing: Pole Mount (1.5" pipe), Antenna Unit

App. M - Outline Drawing: Pole Mount (2.0" pipe, 53.0 mm), Antenna Unit

NOTE: The Pole Mount (2.0" pipe, 53.0 mm), Antenna Unit interfaces to a pipe of maximum 2.0" (53.0 mm), measured outer diameter. The total weight of the Pole Mount is 0.24 kg (0.53 lbs).

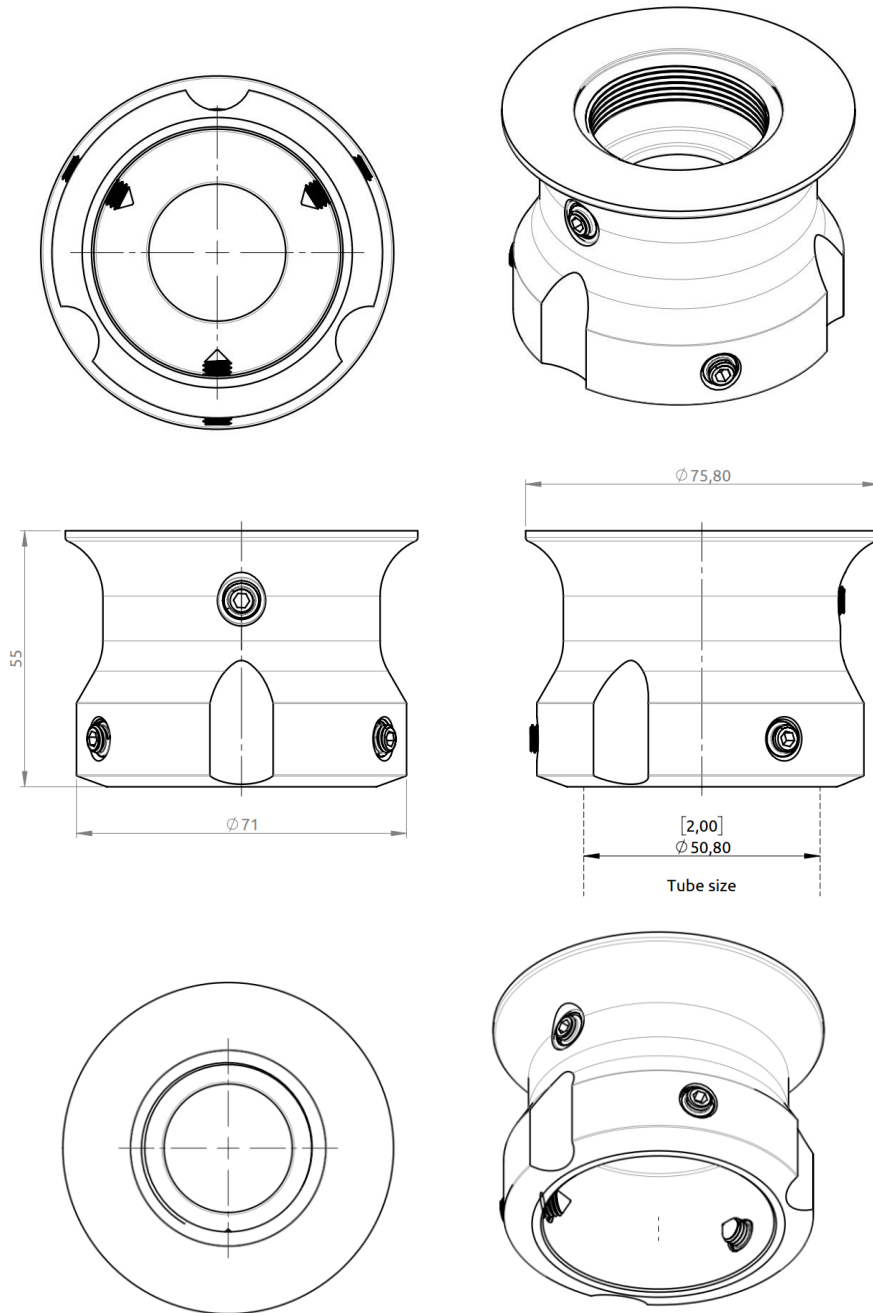

Figure 194: Outline Drawing: Pole Mount (2.0" pipe, $\phi 53.0$ mm), Antenna Unit

App. N - Outline Drawing: Bracket Mount, Antenna Unit

NOTE: The Bracket Mount (1.5" to 2.5" pipe), Antenna Unit interfaces to a pipe of maximum 2.5" (63.5 mm), measured outer diameter. The total weight of the Bracket Mount is 714 g (1.57 lbs). A Cable Hose must be used with the Bracket Mount, for details see *Bracket Mount (1.5" to 2.5" pipe), Antenna Unit* on page 19. The mount is discontinued.

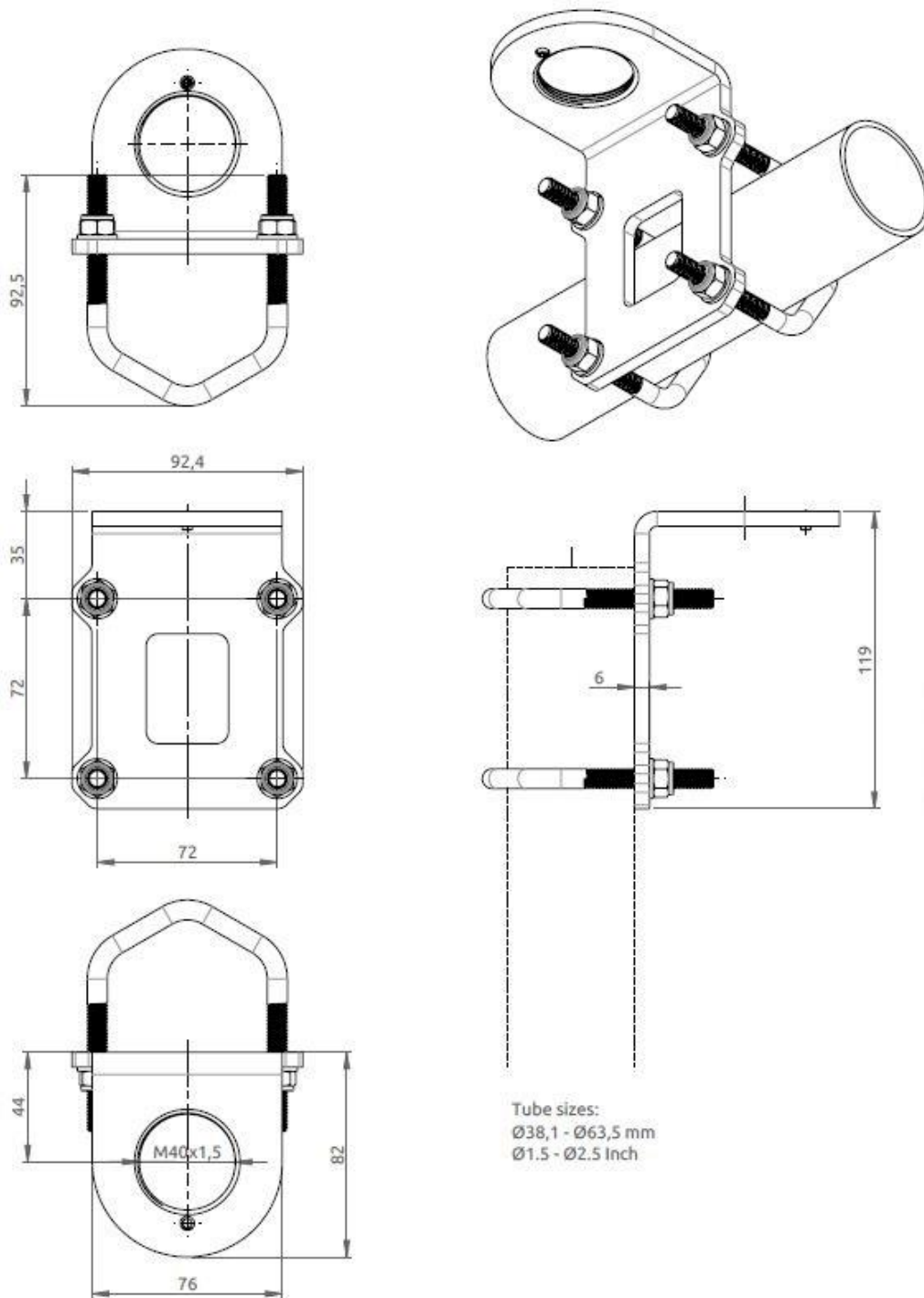

Figure 195: Outline Drawing: Bracket Mount (1.5" to 2.5" pipe), Antenna Unit

App. O - Outline Drawing: LT-3120 Handset

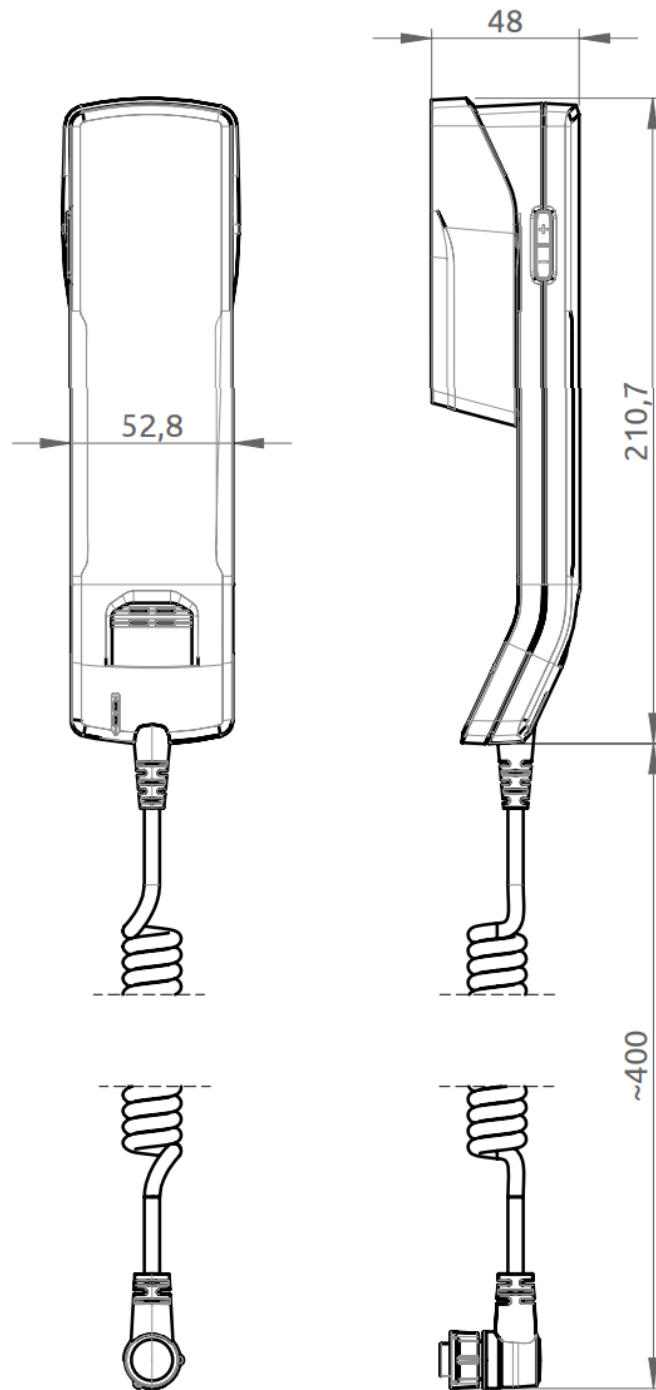

Figure 196: Outline Drawing: LT-3120 Handset

App. P - Outline Drawing: LT-3121 Cradle

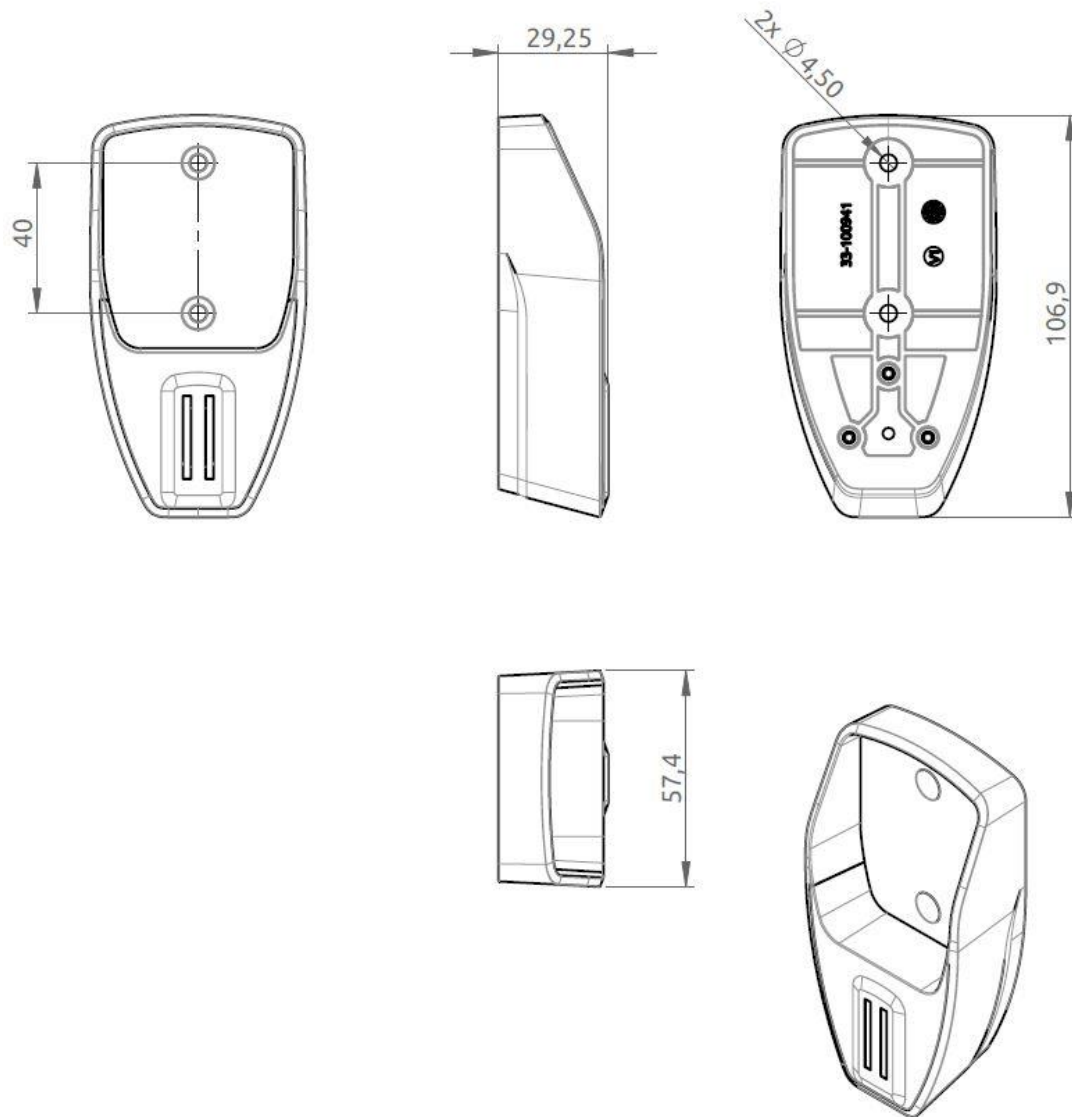

Figure 197: Outline Drawing: LT-3121 Cradle

App. Q - EU Declaration of Conformity

68-101340 Rev. 1.02



EU Declaration of Conformity

This declaration of conformity is issued under the sole responsibility of the manufacturer.

Manufacturer: Lars Thrane A/S

Address: Skovlytoften 33, 2840 Holte, Denmark

Product Identification:

LT-3100 Satellite Communications System

51-100987 LT-3110 Control Unit 51-100988 LT-3120 Handset

51-101181 LT-3121 Cradle 51-100989 LT-3130 Antenna Unit

Product Description

The LT-3100 Satellite Communications System is a maritime satellite communication product. The system has voice and data capabilities with global coverage provided by the Iridium® Communications Network. The LT-3100 system consists of a control unit, antenna unit, handset and cradle. The LT-3100 system can be used as the primary satellite communication product on vessels, covering the basic communication needs in terms of connectivity between the ship and shore.

Declaration

We as manufacturer declare that the above listed product is in conformity with the essential requirements and other relevant requirements of the following Directives:

Radio Equipment Directive 2014/53/EU
RoHS 2 Directive 2011/65/EU

The following harmonized standards and/or other normative documents were applied in full in accordance to Articles 17 of Directive 2014/53/EU:

Directive Article	Test of Requirements	Standard & Version
Article 3.1(a)	Safety	EN 60950-1:2006+A1:2009+A2:2013, EN 60950-1:2006+A11:2009+A1:2010+A12:2011+A2:2013, EN 60950-22:2006 +A11:2008, EN 60945:2002 Clause 7.2 (Clause 5.3)
	Health	EN 62311:2008
Article 3.1(b)	EMC	EN 301 489-1:Draft V2.2.0:2017-03, ETSI EN 301 489-17:Draft V3.2.0:2017-03, ETSI EN 301 489-19:Draft V2.1.0:2017-03, EN 55032:2015, EN 61000-4-3:2006 A1:2009 A2:2010, EN 61000-4-4:2012, EN 61000-4-6:2009
		EN 60945:2002+C1:2008, Section 8.12, Section 8.2.1, Section 8.2.2, Section 8.3, Section 8.4.1, Section 8.4.2, Section 8.7, Section 12.1, EN 60068-2-27:2009 Section 8 EN 60529:1992+A2:2013 Section 14.2.1, 14.2.2
Article 3.2	Radio Spectrum	EN 60945:2002+C1:2008, [CISPR 16-1-2:2006, CISPR 16-1-4: 2007, EN 61000-4-2:1995, EN 61000-4-3:1996, EN 61000-4-4:1995, EN 61000-4-6:1996, EN 61000-4-11:1994]
		EN 300 328:V2.1.1 (2016-11) Clause 4.3.1.10, Clause 4.3.1.11 EN 303 413: V1.1.1 (2017-06) Clause 4.2.2 EN 301 441: V2.1.1 (2016-06) Clause 4.2.1, Clause 4.2.4

The conformity assessment procedure referred to in Article 17 and detailed in Annex III of directive 2014/53/EU has been followed with the involvement of the following Notified Body:

TÜV SÜD BABT, Octagon House, Concorde Way, Segensworth North, Fareham, Hampshire, PO 15 5RL, UK

Identification Number: 0168

Type Examination Certificate No.: BABT-RED001297 I01

The TCF relevant to the above product will be held at Lars Thrane A/S.

Place and date

Holte, 2019-05-03

Peter Thrane, CEO

Lars Thrane A/S

www.thrane.eu

Page 1 of 1

Lars Thrane A/S

Skovlytoften 33

2840 Holte

Denmark

www.thrane.eu