

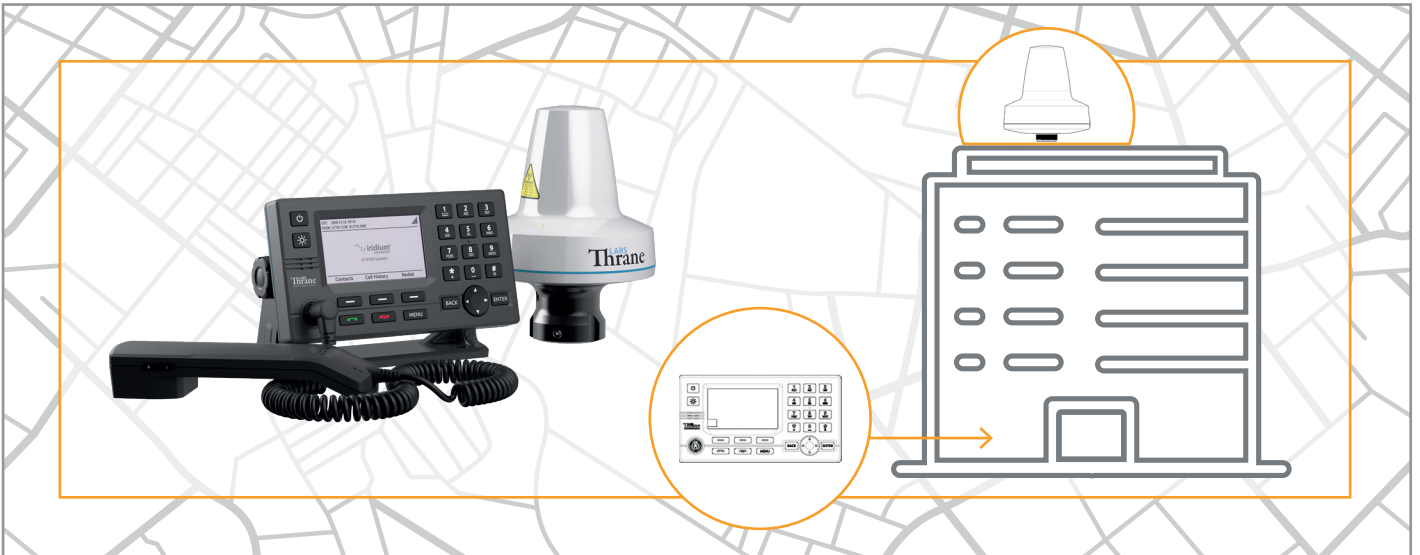

**LT-4100L SATELLITE
COMMUNICATIONS SYSTEM**
IRIDIUM CERTUS® 100 LANDMOBILE
(FIXED INSTALLATION)

FIXED INSTALLATION



LT-4100L IN SHORT

- 2 x Voice Channels (high quality)
- IP-data: 22 kbps (up) / 88 kbps (down)
- High-performance GNSS/GPS receiver
- Single antenna cable solution (up to 500 m)
- Support for external SIP PABX and SIP handsets (up to 8)
- Firewall and user authentication for high level of security
- Web server for configuration and maintenance

PRODUCT DESCRIPTION

The LT-4100L Satellite Communications System (Iridium Certus® 100) is a LandMobile satellite communication product from Lars Thrane A/S. The LT-4100L system is designed for fixed installation only. The LT-4100L system has voice and data capabilities with 100% global coverage provided by the Iridium® Network. The LT-4100L system consists of a control unit, antenna unit, handset, and cradle. The LT-4100L system offers 2 high quality voice channels, and IP-data 22 kbps (up) / 88 kbps (down), making it the perfect satcom communication product for any fixed installation.

PRODUCT FEATURES

VOLUME CONTROL

Handset speaker volume control button

RINGER

Incoming call ringer

MICROPHONE

High-quality microphone

COLOR DISPLAY

Large 4.3" TFT display supporting brightness adjustment and day/night mode themes

KEYPAD

Responsive keypad with brightness adjustments

AUDIO SPEAKER

Audio speaker supporting key beep, voice prompt, and alarms

FUNCTIONAL KEYS

Functional keys; off-hook, on-hook, navigation, and soft keys

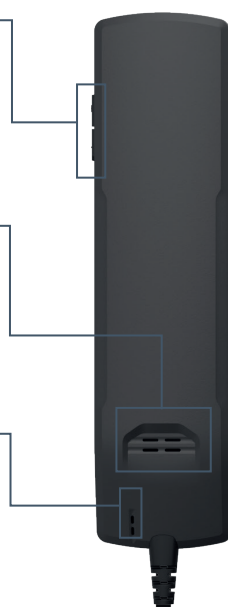

INTERFACES

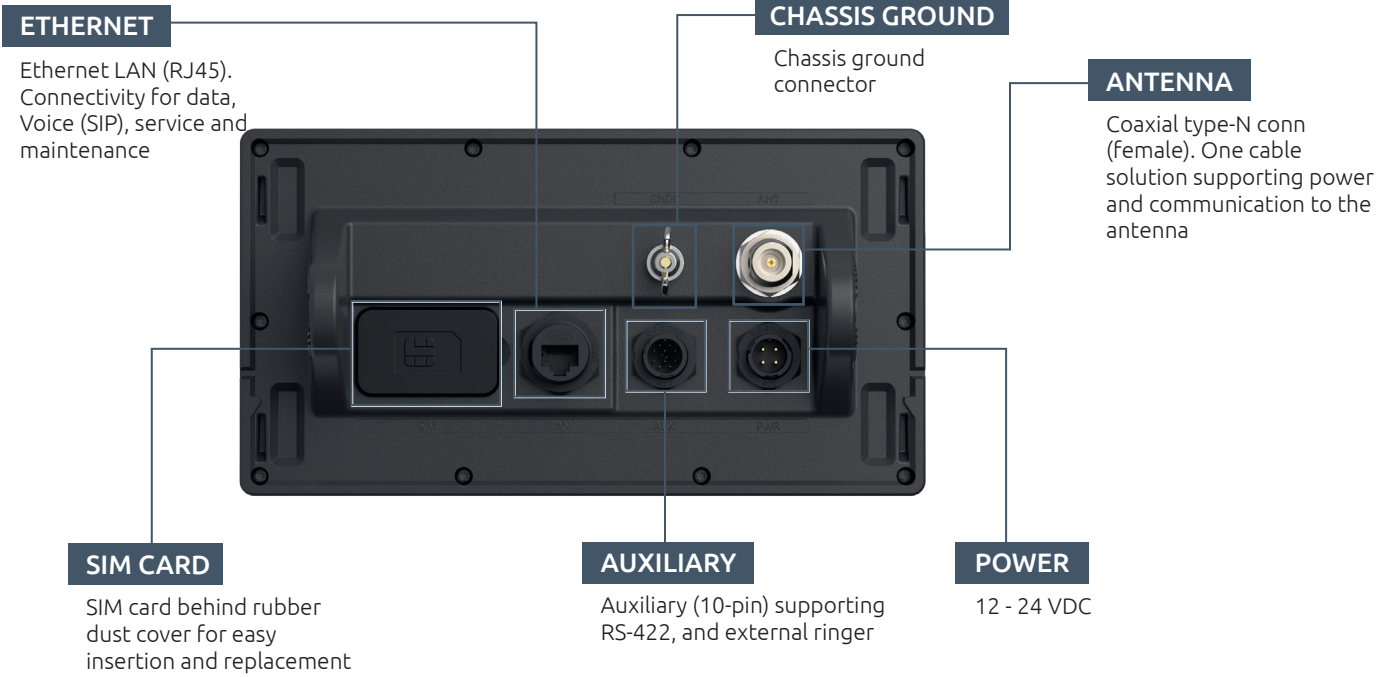

INSTALLATION OPTIONS

ANTENNA MOUNTING KITS



Pole Mount
(1.5" pipe, Ø38.8mm)
Antenna Unit



Pole Mount
(2.0" pipe, Ø53.0mm)
Antenna Unit



Bracket Mount
Control Unit

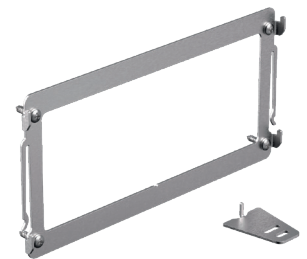

Flush Mount
Control Unit

CONTROL UNIT MOUNTING KITS

SYSTEM CONFIGURATION

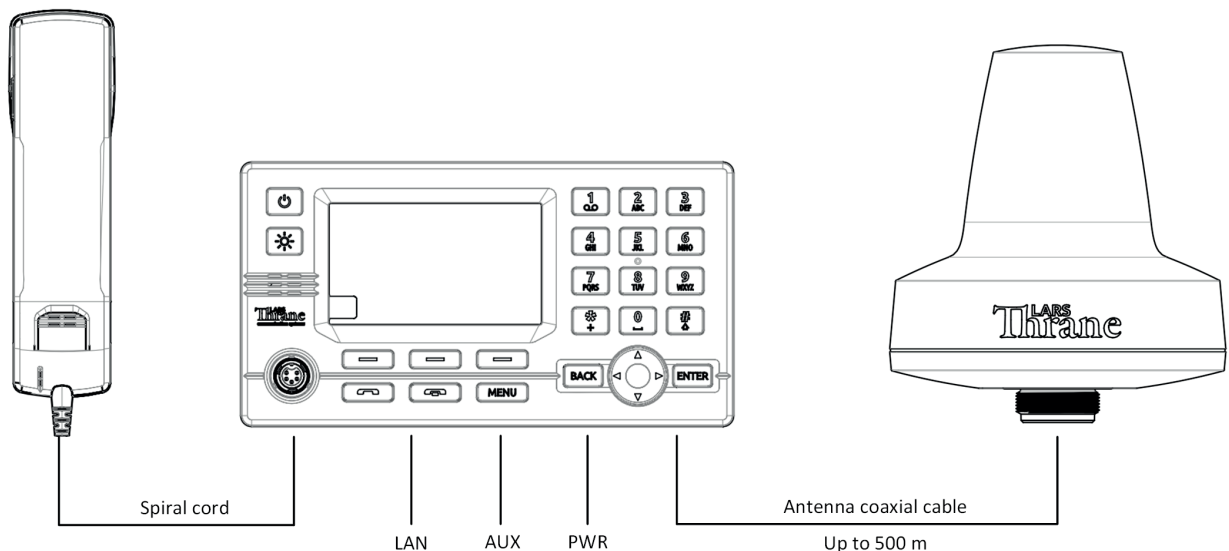

SPECIFICATIONS

LT-4100L SATELLITE COMMUNICATIONS SYSTEM

Certification & standards	CE, FCC, ISED, RED, RoHS 2, Iridium®
Vibration, operational	IEC 60945
Vibration, shock	Half sine 20 g/11 ms
Compass Safe Distance, std.	0.3 - 1.4 m (1.0 - 4.6 ft)
Compass Safe Distance, steer.	0.3 - 0.9 m (1.0 - 3.0 ft)
Power consumption: operating mode, max	24 W
Power consumption: Idle	9 W

LT-4110 Control Unit

Weight	0.67 kg (1.48 lbs)
Dimensions	224.0 x 120.0 x 70.0 mm (8.82 x 4.72 x 2.76 in)
Temperature, operational	-15°C to +55°C (+5°F to +131°F)
IP rating, dust and water	IP32
Interfaces	Ethernet, auxiliary, DC input, chassis ground Antenna Unit (N conn.), handset, Bluetooth, SIM card
Input power	12-24 VDC (2.0-1.0 A)*

LT-3120 Handset Unit

Weight (handset + wire)	0.30 kg (0.66 lbs)
Dimensions	52.8 x 208.8 x 38.2 mm (2.08 x 8.22 x 1.50 in)
Temperature, operational	-15°C to +55°C (+5°F to +131°F)
IP rating, dust and water	IP32

LT-4130L Antenna Unit

Weight	1.39 kg (3.05 lbs)
Dimensions	182 x Ø 162 mm (7.16 x Ø 6.39 in)
Temperature, operational	-40°C to +55°C (-40°F to +131°F)
IP rating, dust and water	IP67
Interfaces	Control Unit (N conn.)
Antenna communication cable	Coaxial cable, up to 500 m (1500 ft)
Warranty	2 years
Maintenance	None

* When 12 VDC input power is used, the maximum cable length will be reduced and thus less power.

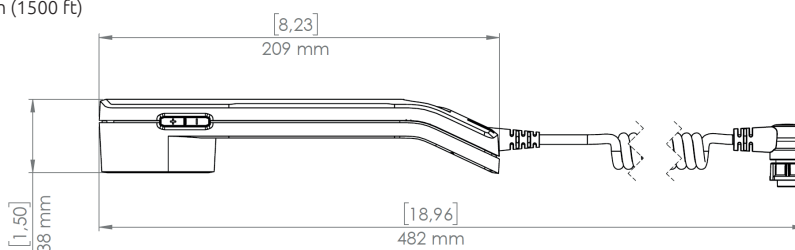
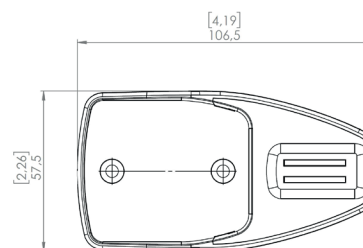
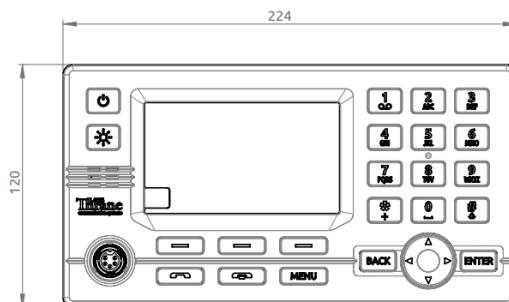
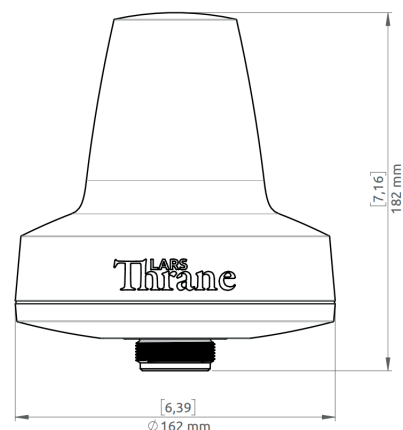

IN THE BOX

LT-4110 Control Unit	P/N: 51-102663
LT-3120 Handset	P/N: 51-100988
LT-3121 Cradle	P/N: 51-101181
LT-4130L Antenna Unit (LandMobile)	P/N: 51-102827
Bracket Mount, Control Unit	P/N: 91-100771
Power Cable, 3m	P/N: 91-102118
User & Installation Manual	P/N: 95-102576

ACCESSORIES

Flush Mount, Control Unit	P/N: 91-100772
Pole Mount (1.5" pipe, Ø38.8mm), Antenna Unit	P/N: 91-100774
Pole Mount (2.0" pipe, Ø53.0mm), Antenna Unit	P/N: 91-102550
Auxiliary Cable, 3m	P/N: 91-100768
Coaxial Cable Ø4.9mm (up to 100m)	
Coaxial Cable Ø10.3mm (up to 500m)	
Crimping Tool for Coaxial Cable Ø4.9mm and Ø10.3mm	



Lars Thrane A/S
 Skovlytoften 33
 DK-2840 Holte, Denmark
 Phone: +45 88 30 10 00 Fax: +45 88 30 10 09
 Email: sales@thrane.eu
 CVR DK-36042443
 www.thrane.eu